

REALSTAR SURGICAL INSTRUMENTS

01 **SURGICAL**
Instruments

TABLE OF CONTENTS

REALSTAR SURGICAL INSTRUMENTS

DESCRIPTION	PAGE #
DIAGNOSTIC, ANAESTHESIA, SCALPELS & KNIVES	1-21
SCISSORS	22-51
FORCEPS, CLAMPS	52-94
NEEDLE HOLDERS	95-100
SUTURE INSTRUMENTS & PROBES	101-113
HOOKS & RETRACTORS	114-165
ABDOMINAL SURGERY, INTESTINAL & RECTAL INSTRUMENTS	166-191
GALL BLADDER, LIVER & SPLEENS INSTRUMENTS URINARY INSTRUMENTS & TROCARS	192-206
VAGINAL SPECULA & RETRACTORS	207-218
UTRINE DIALATORS, PROBES, FORCEPS MYOMA INSTRUMENTS	219-234
BIOPSY INSTRUMENTS	235-243
OBSTETRICS	244-252
TRACHEOTOMY, CARDIOVASCULAR & THORACIC SURGERY	253-307
BONE PUNCHES & RONGERS	308-316
AMPUTATION, ELEVATORS, RASPATORIES, BONE LIVERS, BONE FILES & CURETTES	317-346
MALLETS, TAMPERS, CHISELS, GAUGES, BONE HOLDING FORCEPS, BONE RONGEURS, BONE CUTTING FORCEPS, MENISCUS INSTRUMENTS	347-378
WIRE EXTENSION, FINGER NAIL INSTRUMENTS	379-392
PLASTER INSTRUMENTS	393-397
SUCTION INSTRUMENTS	398-404
TUNGSTEN CARBIDE INSERTS	405-416
HOSPITAL WARES	417-427

Percussion Hammers & Aesthesiometers

REALSTAR SURGICAL INSTRUMENTS



01-101
TROEMNER
Size: 245 mm



01-102
DEJERINE
Size: 200 mm



01-103
DEJERINE
With Needle
Size: 210 mm



01-104
TAYLOR
Size: 195 mm



01-105
BERLINER
Size: 200 mm

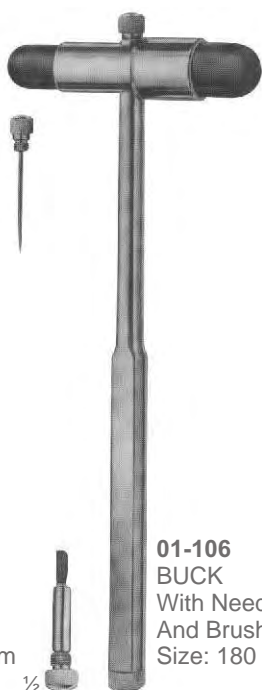

01-106
BUCK
With Needle
And Brush
Size: 180 mm



01-107
RABINER
With Needle
And Brush
Size: 255 mm



01-108
ALY
Size: 190 mm



01-109
WARTENBERG
Pinwheel For
Neurological
Examination
Size: 185 mm

Stethoscopes

REALSTAR SURGICAL INSTRUMENTS



01-110
PINARD (Aluminum)
Size: 155 mm

1/2



01-111
aus Holz (Wooden)
Size: 145 mm

1/2



01-112
BOWLES
Stethoscope
With Diaphragm

1/4



01-113
ANESTOPHON

1/3

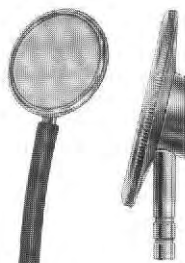

01-114
FORD-BOWLES
Duel Chest Piece
With Two Outlets

1/4



01-115
BOWLES

1/4

Head Mirrors & Head Bands

REALSTAR SURGICAL INSTRUMENTS



01-116
ZIEGLER \varnothing mm
Head mirror only
with rubber coating



01-117
ZIEGLER \varnothing mm
Head mirror only
with metal coating



01-118
ZIEGLER
Head band of plastic black

01-119
ZIEGLER
Head band of plastic white



01-120
MURPHY
Head band of celluloid, white

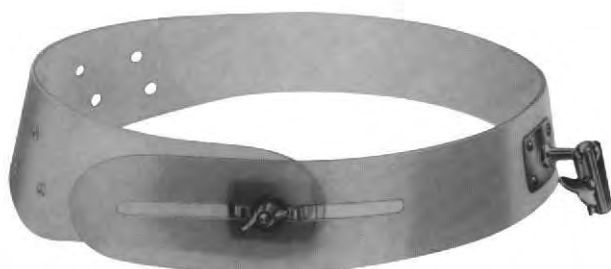

01-121
Head band of plastic,
white, soft pattern



01-122
Head mirror with black
plastic head band.

Head Light

REALSTAR SURGICAL INSTRUMENTS

01-123

CLAR

Head light, 6 volt, with adjustable joint, white celluloid head band, cord with plugs for transformer

01-124

White celluloid head band, only, for

01-125

Spare mirror only, for



01-126
spare bulb

01-127

CLAR

Head light, 6 volt, with adjustable joint, white celluloid head band, with foam rubber pad and cord with plugs for transformer

01-128

White celluloid head band, only, for head light

01-129

mirror only, for head light

spare foam rubber pad, for head band

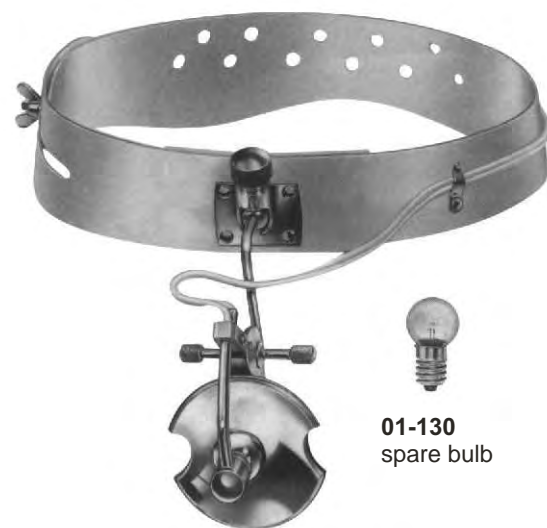

01-130
spare bulb

01-131

CLAR

Head light, 6 volt, with adjustable joint, white plastic head band, cord with plugs for transformer



01-132
spare bulb

Tongue Depressors

REALSTAR SURGICAL INSTRUMENTS

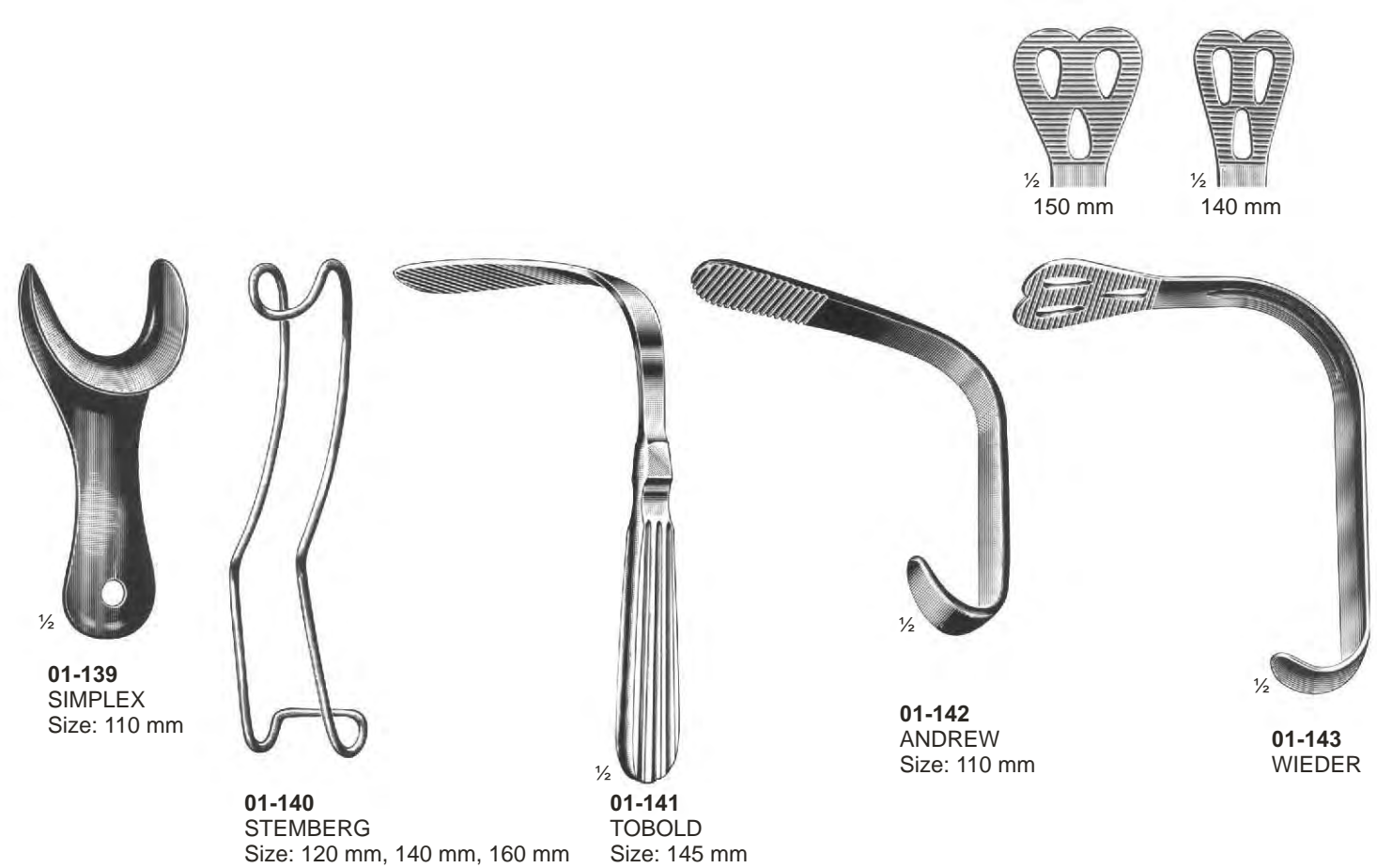
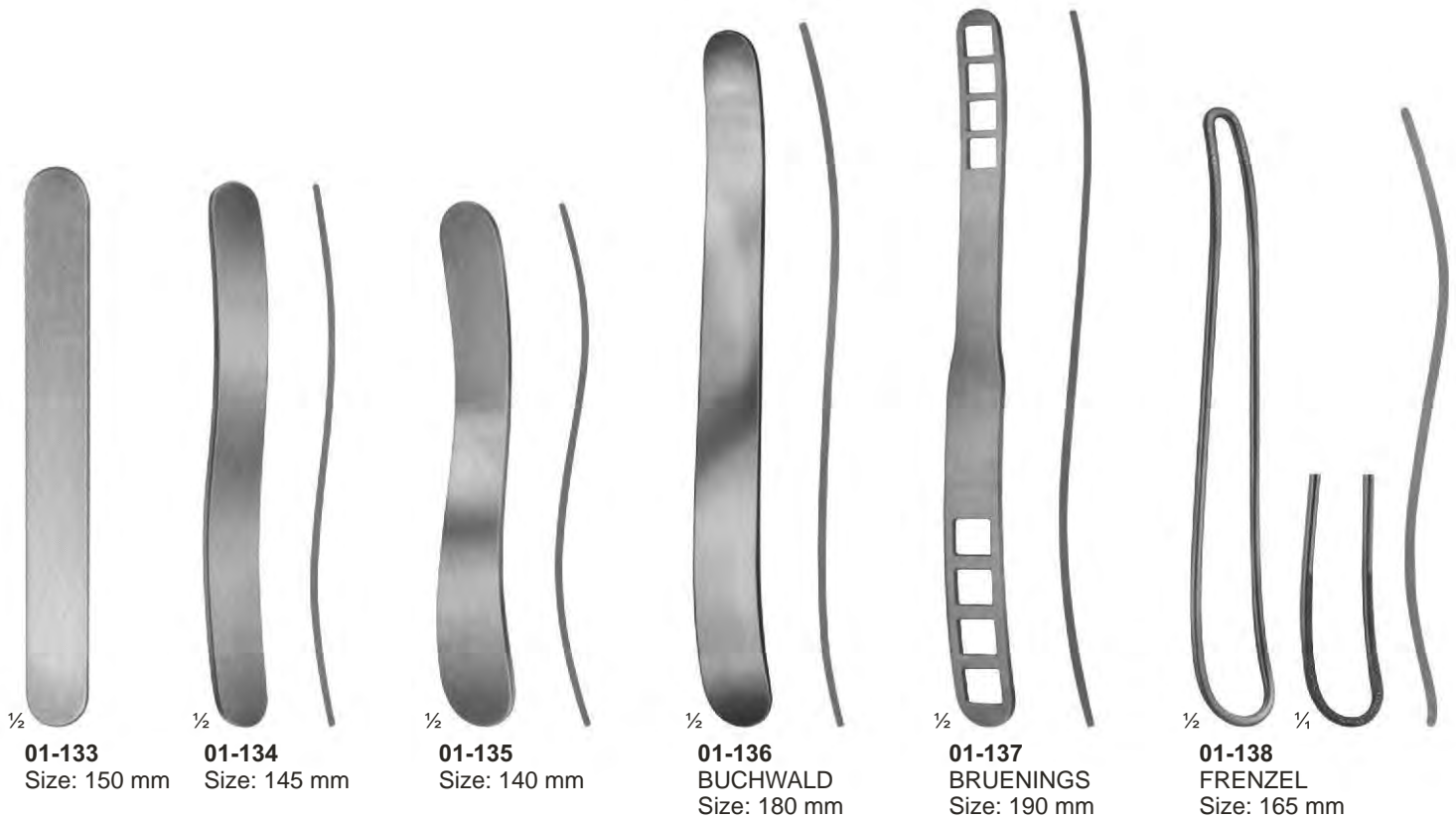

Tongue Depressors

REALSTAR SURGICAL INSTRUMENTS



1/2

01-144
SCHIMMELBUSCH
Ether Mask



1/2

01-145
HEISTER
Mouth Gag
Size: 130 mm



1/2

01-146
FERGUSSON-ACKLAND
Mouth Gag
Size: 145 mm



1/2

01-147
DENHARDT
Mouth Gag With Silicon
Inserts, Interchangeable
Size: 125 mm



1/2

01-148
ROSER KONIG
Mouth Gag
Size: 160 mm, 185 mm



1/2

01-149
YOUNG
Size: 165 mm



1/4

1 Pair Of
Rubber Pads

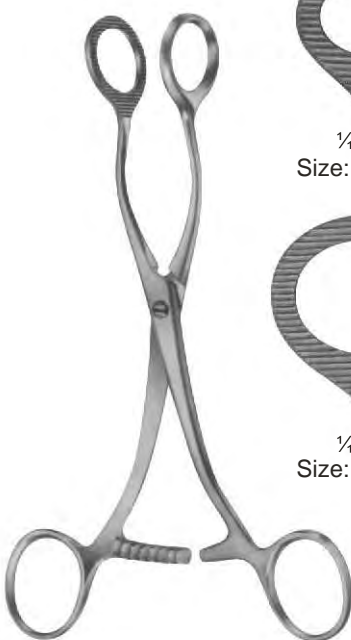

1/2

01-150
COLLIN
Size: 160 mm, 170 mm



1/4

Size: 160 mm



1/4

Size: 170 mm

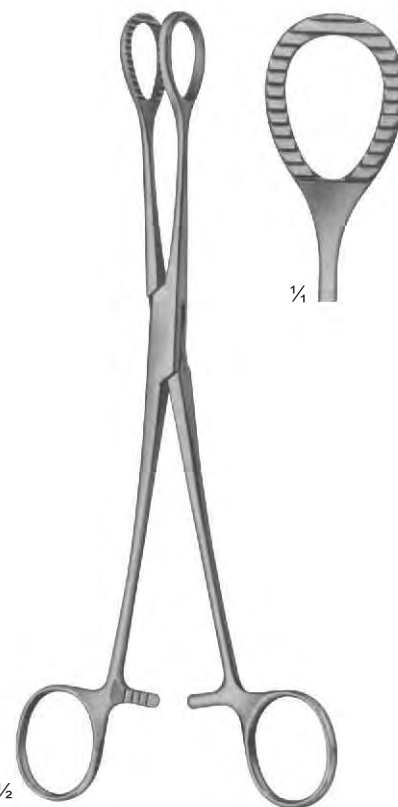

1/2

01-151
HEYWOOD-SMITH modif.
Size: 215 mm

Blood Lancets & Laryngeal Mirrors

REALSTAR SURGICAL INSTRUMENTS



01-152
FRANCKE
Automatic Blood Lancet



01-153
KOLLE
Microscopic Needle Holder
With Plastic Handle
Size: 240 mm

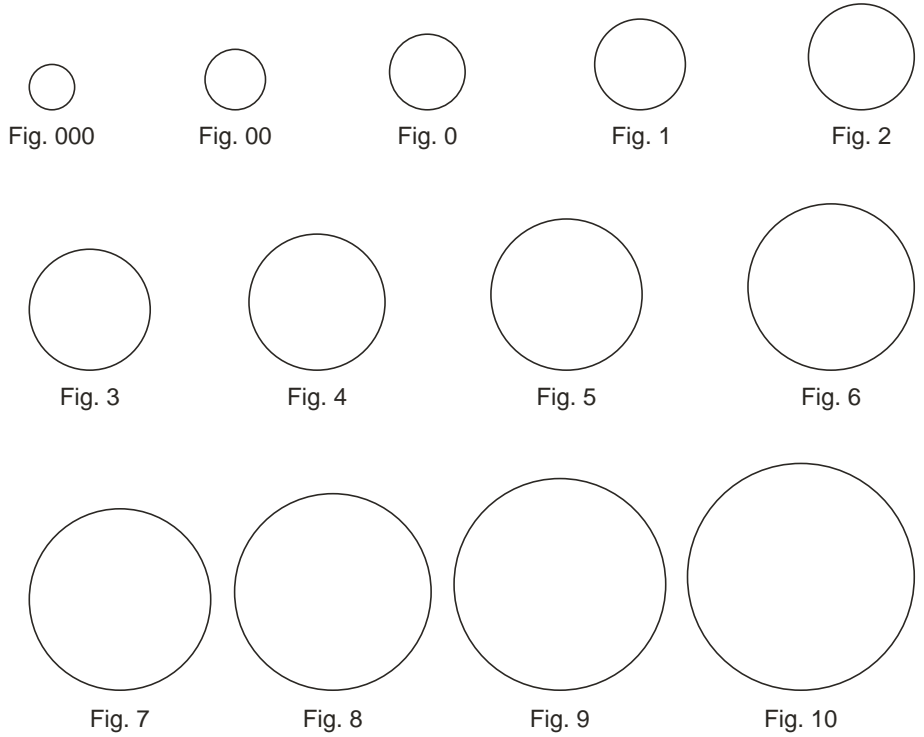

01-154
Laryngeal Mirrors With
Hexagonal Handle
Size: 180 mm



01-155
Mirror Handle
Size: 110 mm



01-156
Mirror Handle
Size: 105 mm



01-157
MICHEL
Rhinoscopic Mirrors With
Interchangeable Mirror Inserts
Size: 250 mm



01-158
Spare Mirrors Only
Size: 12 mm



01-159
Spare Mirrors Only
Size: 14 mm

Diagnostic Sets

REALSTAR SURGICAL INSTRUMENTS



01-160 - 162
MAGILL



01-160
Infants
Size: 150 mm



01-161
Children
Size: 200 mm



01-162
Adults
Size: 250 mm



01-163
Medium battery handle
only, 25 mm diam.



01-163-A
Spare bulb
2.7 volt, for
autosscopes



01-163-B
Spare bulb
2.6 volt, for
ophthalmoscopes



01-164
Otoscope Set, Consists Of
Battery Handle Without Batteries,
3 Ear Specula, 1 Bulb In Velvet Lined Case



01-165
Diagnostic Set, Otoscope With Three Specula,
Nasal Speculam, Lamp Holder, Two Laryngeal
Mirrors, Tongue Blade Holder

Diagnostic Sets

REALSTAR SURGICAL INSTRUMENTS



1/3

01-166
MILLER
 Laryngoscope Set, Consists Of Battery Handle (Without Battery)
 With Four Miller Laryngoscope Blades

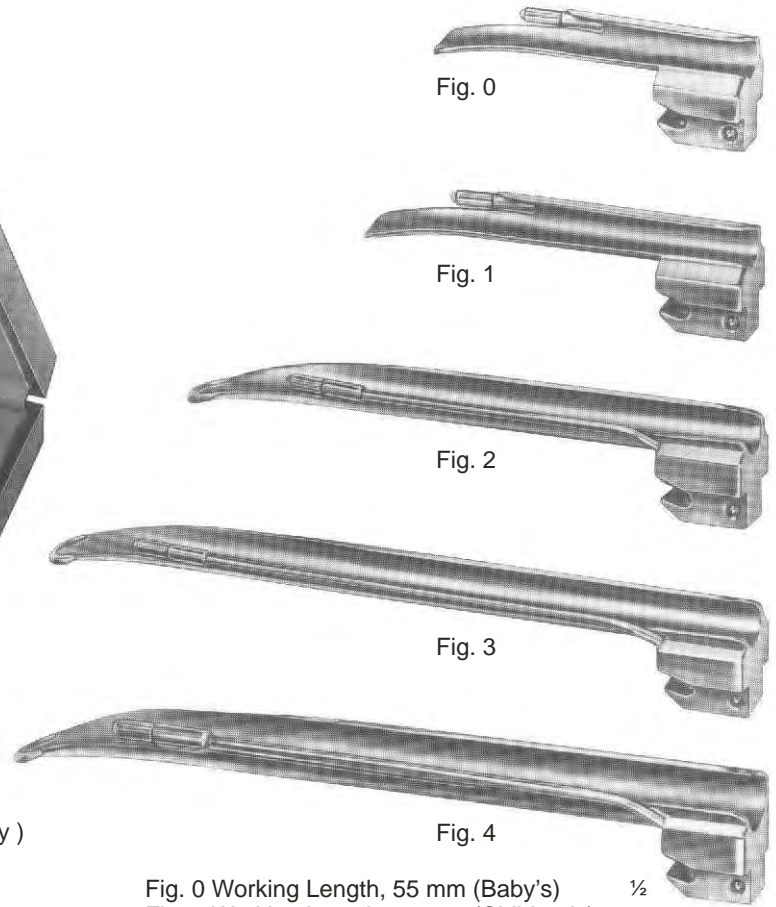

Fig. 0

Fig. 1

Fig. 2

Fig. 3

Fig. 4

Fig. 0 Working Length, 55 mm (Baby's) 1/2
 Fig. 1 Working Length, 80 mm (Children's)
 Fig. 2 Working Length, 130 mm (Adolescent's)
 Fig. 3 Working Length, 170 mm (Women's)
 Fig. 4 Working Length, 180 mm (Men's)



1/3

01-167
GUEDEL-NEGUS
 Laryngoscope Set, Consists Of Battery Handle (Without Battery)
 With Four Miller Laryngoscope Blades

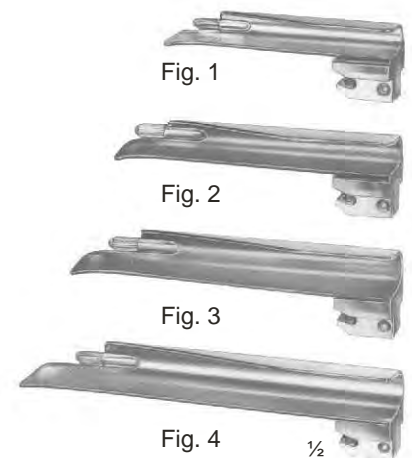

Fig. 1

Fig. 2

Fig. 3

Fig. 4 1/2

Fig. 1 Working Length, 70 mm (Children's)
 Fig. 2 Working Length, 90 mm (Adolescent's)
 Fig. 3 Working Length, 110 mm (Women's)
 Fig. 4 Working Length, 135 mm (Men's)

Diagnostic Sets

REALSTAR SURGICAL INSTRUMENTS



01-168
McIntosh
Laryngoscope Set, Consists Of Battery Handle (Without Battery)
With Three McIntosh Blades, Fig. 1, Fig. 2, Fig. 3

1/3

01-169
McIntosh
Laryngoscope Set, Consists Of Battery Handle (Without Battery)
With Five McIntosh Blades, Fig. 1, Fig. 2, Fig. 3, Fig. 4, Fig. 5

Fig. 0

Fig. 1

Fig. 2

Fig. 3

Fig. 4

1/2

- Fig. 0 Working Length, 55 mm (Baby's)
- Fig. 1 Working Length, 75 mm (Children's)
- Fig. 2 Working Length, 90 mm (Adolescent's)
- Fig. 3 Working Length, 110 mm (Women's)
- Fig. 4 Working Length, 135 mm (Men's)



01-170
FOREGGER
Laryngoscope Set, Consists Of
Battery Handle (Without Battery)
With Three Foregger Blades,
Fig. 1, Fig. 2, Fig. 3,

1/3

01-171
FOREGGER
Laryngoscope Set, Consists Of
Battery Handle (Without Battery)
With Five Foregger Blades,
Fig. 1, Fig. 2, Fig. 3, Fig. 4, Fig. 5

Fig. 1

Fig. 2

Fig. 3

Fig. 4

1/2

- Fig. 1 Working Length, 70 mm (Children's)
- Fig. 2 Working Length, 90 mm (Adolescent's)
- Fig. 3 Working Length, 110 mm (Women's)
- Fig. 4 Working Length, 135 mm (Men's)



1/2

01-172
Fiber Optic
Battery Handle



1/2

01-173
Fiber Optic
Battery Handle



1/4

01-174
Replacement Lamp
(Krypton) 2.5 V



1/4

01-175
Replacement Lamp
(Halogen) 2.5 V

Examination & Measuring Instruments

REALSTAR SURGICAL INSTRUMENTS

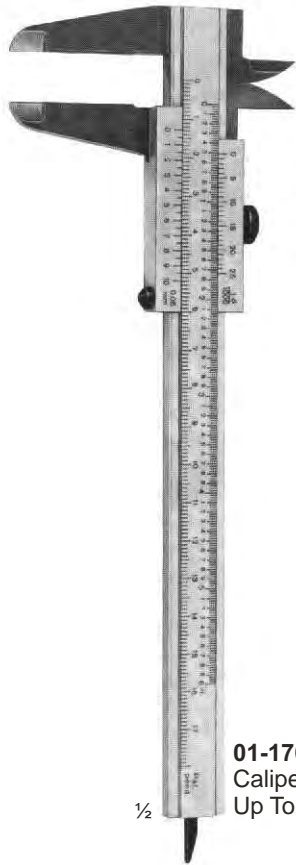

01-176
Caliper Of Aluminum
Up To 180 mm



01-177
VERNIER
Universal Caliper Of Steel
Up To 120 mm



01-178
CAROLL
Size: 140 mm



01-179
TOWNLEY
Size: 100 mm

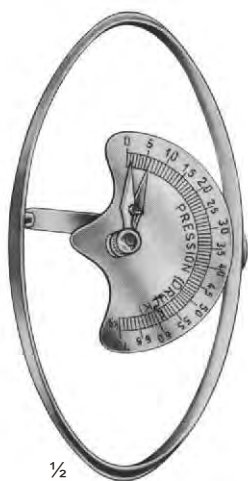

01-180
COLLIN
Druck Pressure 72 kg
Size: 125 mm



01-181
BERTILLON
Caliper For Measuring The Head
Size: 320 mm



01-182
CASTROVIEJO
Caliper



01-183
MOLTGEN
Goniometer



01-185
Size: 150 mm



01-184
Size: 500 mm

Dissecting Knives

REALSTAR SURGICAL INSTRUMENTS



1/2

02-101 - 110
Fig. 1 - 10



1/4

02-101
Fig. 1



02-102
Fig. 2



02-103
Fig. 3



02-104
Fig. 4



02-105
Fig. 5



1/4

02-106
Fig. 6



02-107
Fig. 7



02-108
Fig. 8



02-109
Fig. 9



02-110
Fig. 10

Autopsy & Cartilage Knives

REALSTAR SURGICAL INSTRUMENTS

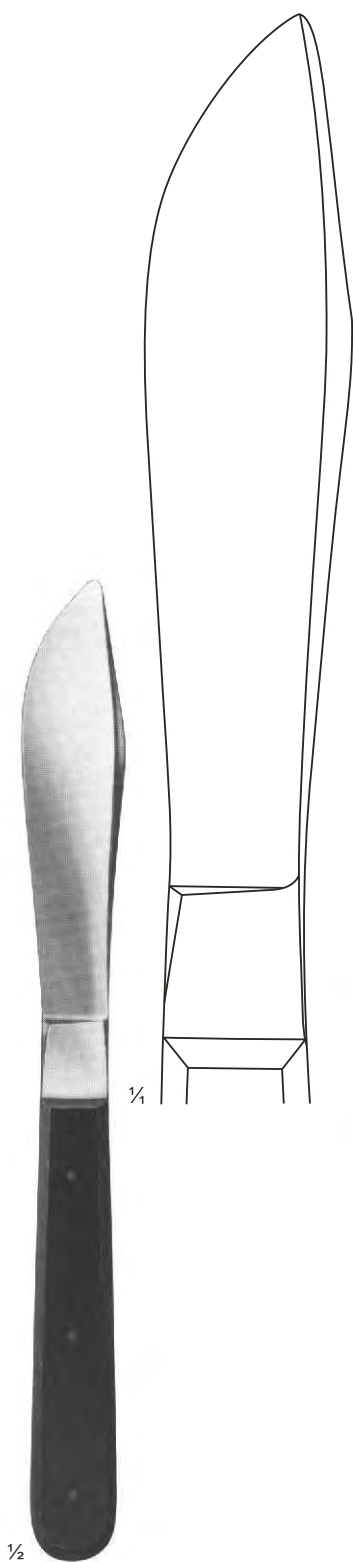

02-111
Size: 255 mm

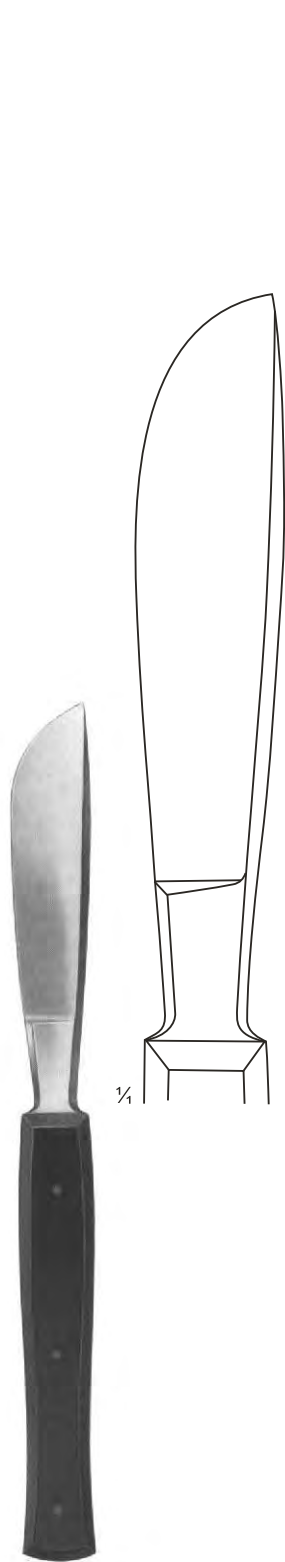

02-112
VIRCHOW



02-113 - 115
WALB

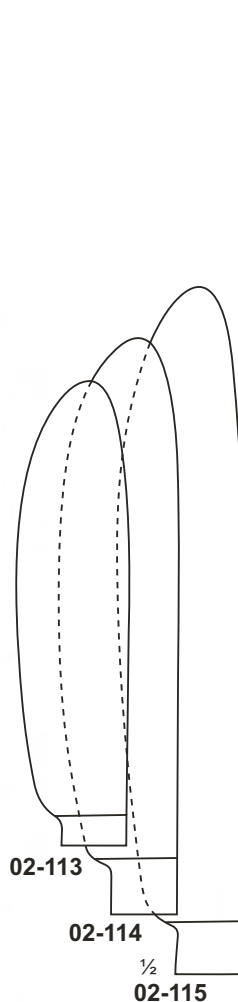

02-113
02-114
02-115

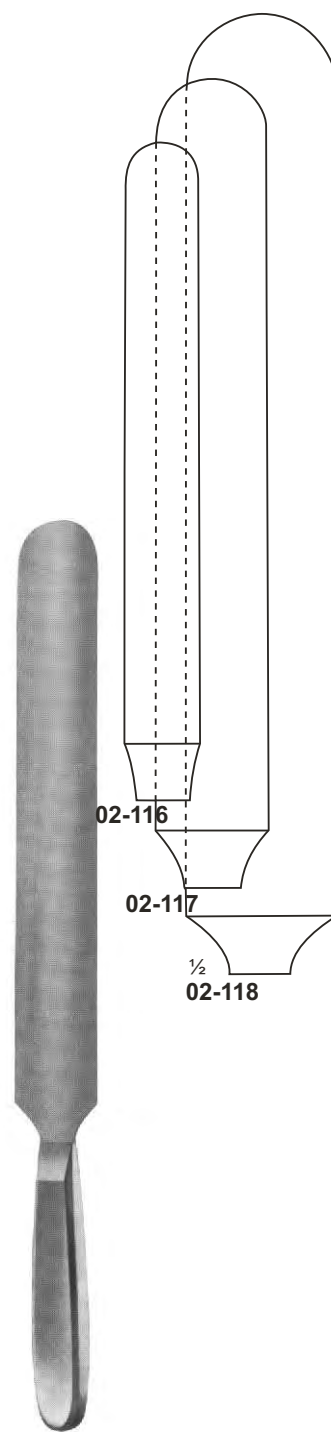

02-116 - 118
VIRCHOW

Scalpels, Tenotomes & Resection Knives

REALSTAR SURGICAL INSTRUMENTS

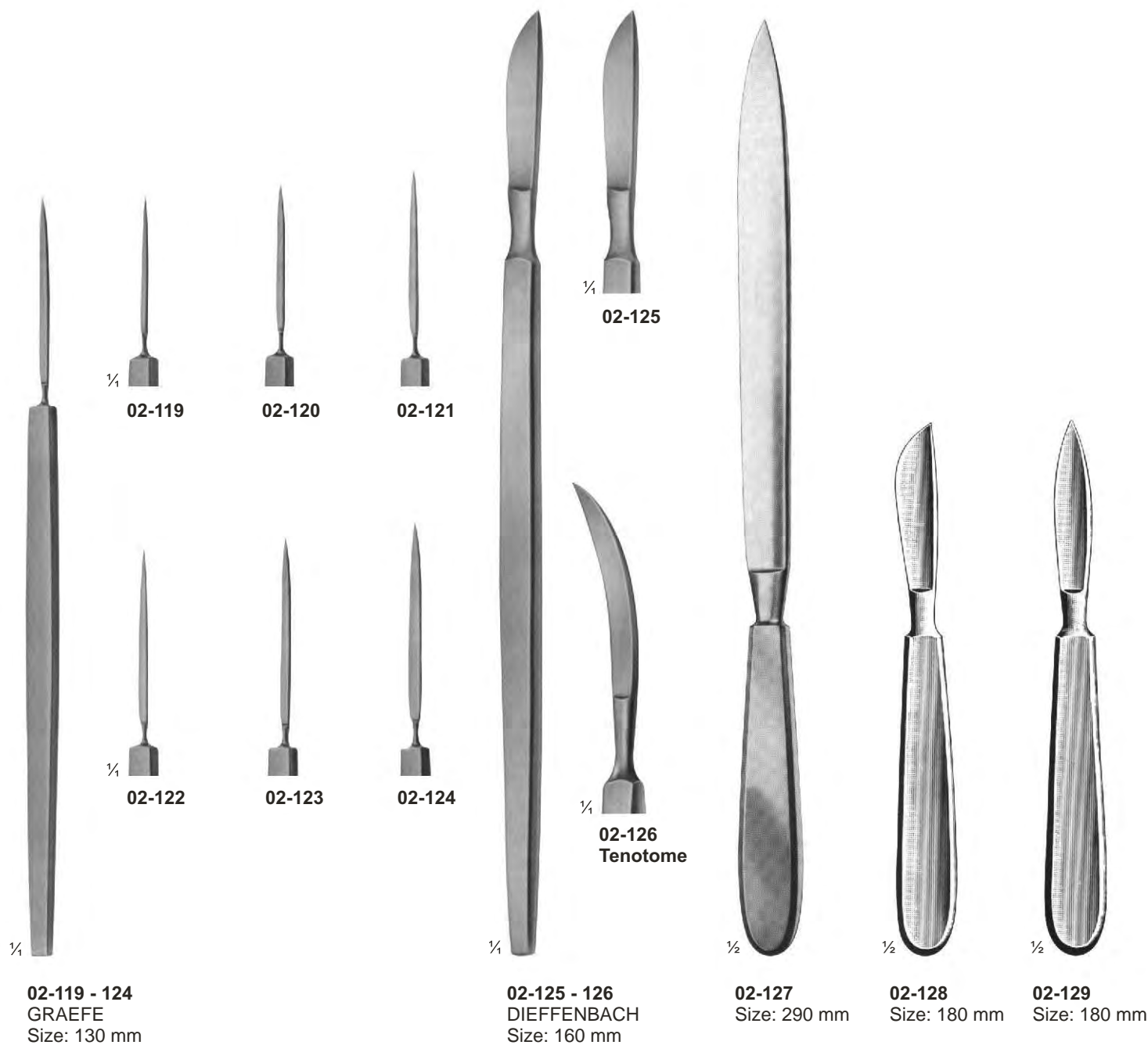

Scalpels, Tenotomes

REALSTAR SURGICAL INSTRUMENTS

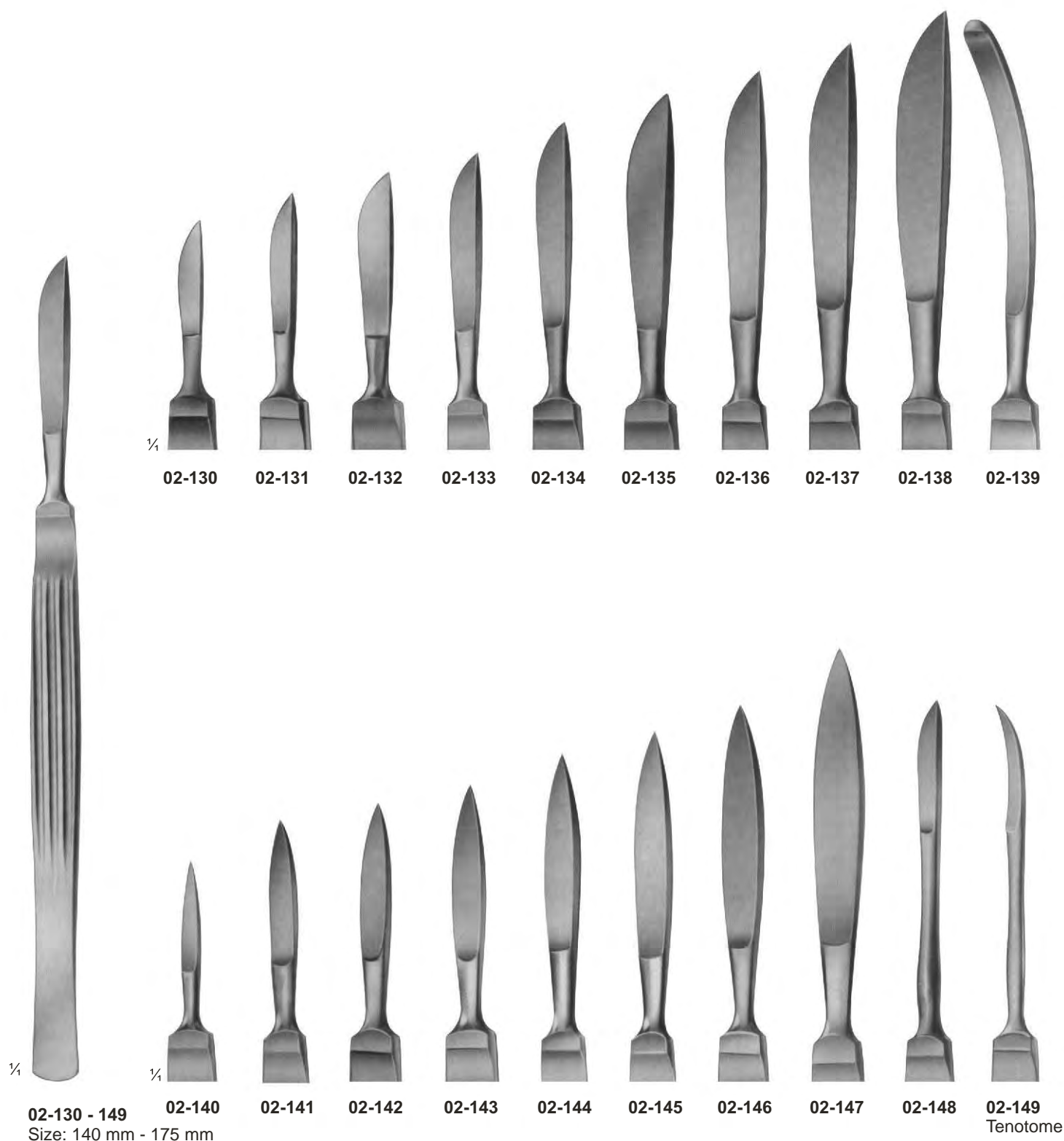

Amputating Knives, Cartilage Knives, Autopsy Knives

REALSTAR SURGICAL INSTRUMENTS



02-150
Size: 130 mm
02-151
Size: 160 mm
02-152
Size: 190 mm
02-153
Size: 200 mm

Blade Length
Amputating Knives

02-154
CATLIN
Size: 160 mm
Blade Length
Amputating
Knives

02-155
LANGENBECK
Size: 120 mm
Blade Length
Flap Knives

02-156
Size: 110 mm
Blade Length
Interosseous
Knives

02-157
Size: 55 mm
Blade Length
With Raspatory,
Wooden Handle

02-158
Size: 70 mm
Blade Length
Wooden Handle

02-159
Size: 80 mm
Blade Length
Metal Handle

02-160
Size: 195 mm
Blade Length
Metal Handle

Cone Knives, Myomatome, Trigeminal & Tonsil Knives

REALSTAR SURGICAL INSTRUMENTS



02-161
AYRE
Size: 235 mm
Cone Knife

02-162
Size: 230 mm
Cone Knife

02-163
SEGOND
Size: 270 mm
Myomatome

02-164
OLIVECRONA
Size: 205 mm
Trigeminal
Knife

02-165
Size: 230 mm
Trigeminal
Knife

02-166
FOWLER
Size: 200 mm
Tonsil Knife

02-167
ABRAHAM
Size: 215 mm
Tonsil Knife

02-168
BRUNINGS
Size: 215 mm
Tonsil Knife

Scalpels, Dura Knives & Comedone Extractors

REALSTAR SURGICAL INSTRUMENTS

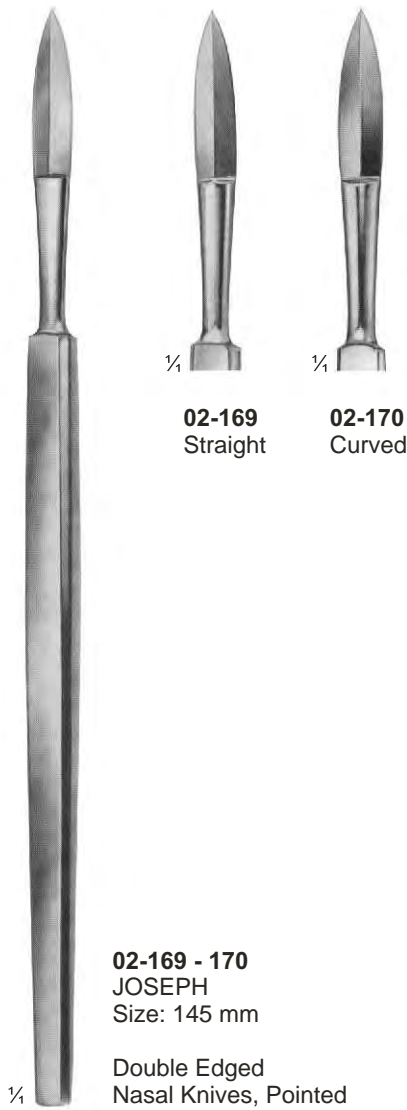

02-169
Straight

02-170
Curved

02-169 - 170
JOSEPH
Size: 145 mm

Double Edged
Nasal Knives, Pointed

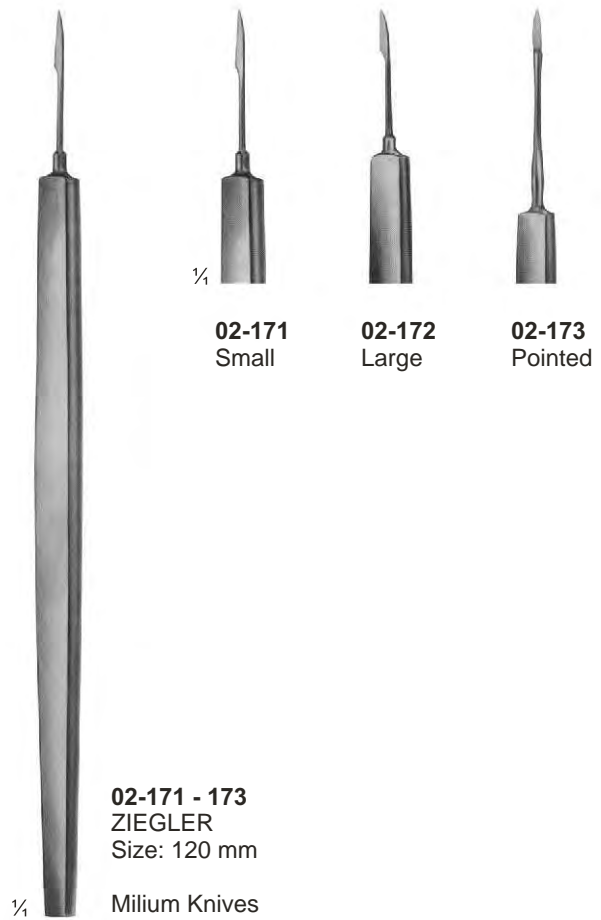

02-171
Small

02-172
Large

02-173
Pointed

02-171 - 173
ZIEGLER
Size: 120 mm

Millium Knives



02-174
VIDAL
Lupus Scraper
Size: 135 mm

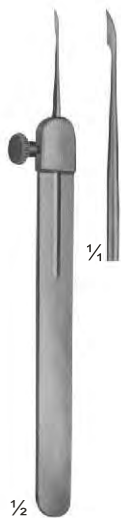

02-175
MONCORPS
Millium Knives
Size: 130 mm



02-176
SAALFELD
Size: 100 mm

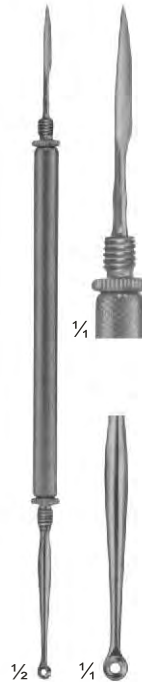

02-177
HEBRA
Size: 180 mm



02-178
Size: 145 mm



02-179
UNNA
Size: 145 mm

Razor Blade Holders & Breakers

REALSTAR SURGICAL INSTRUMENTS



02-180
TROUTMAN-CHRIS
Size: 100 mm



02-181
TROUTMAN-CHRIS
Size: 100 mm



02-182
Size: 110 mm



02-183
CASTROVIEJO
Size: 130 mm



02-184
Size: 185 mm

Scalpel Handles

REALSTAR SURGICAL INSTRUMENTS

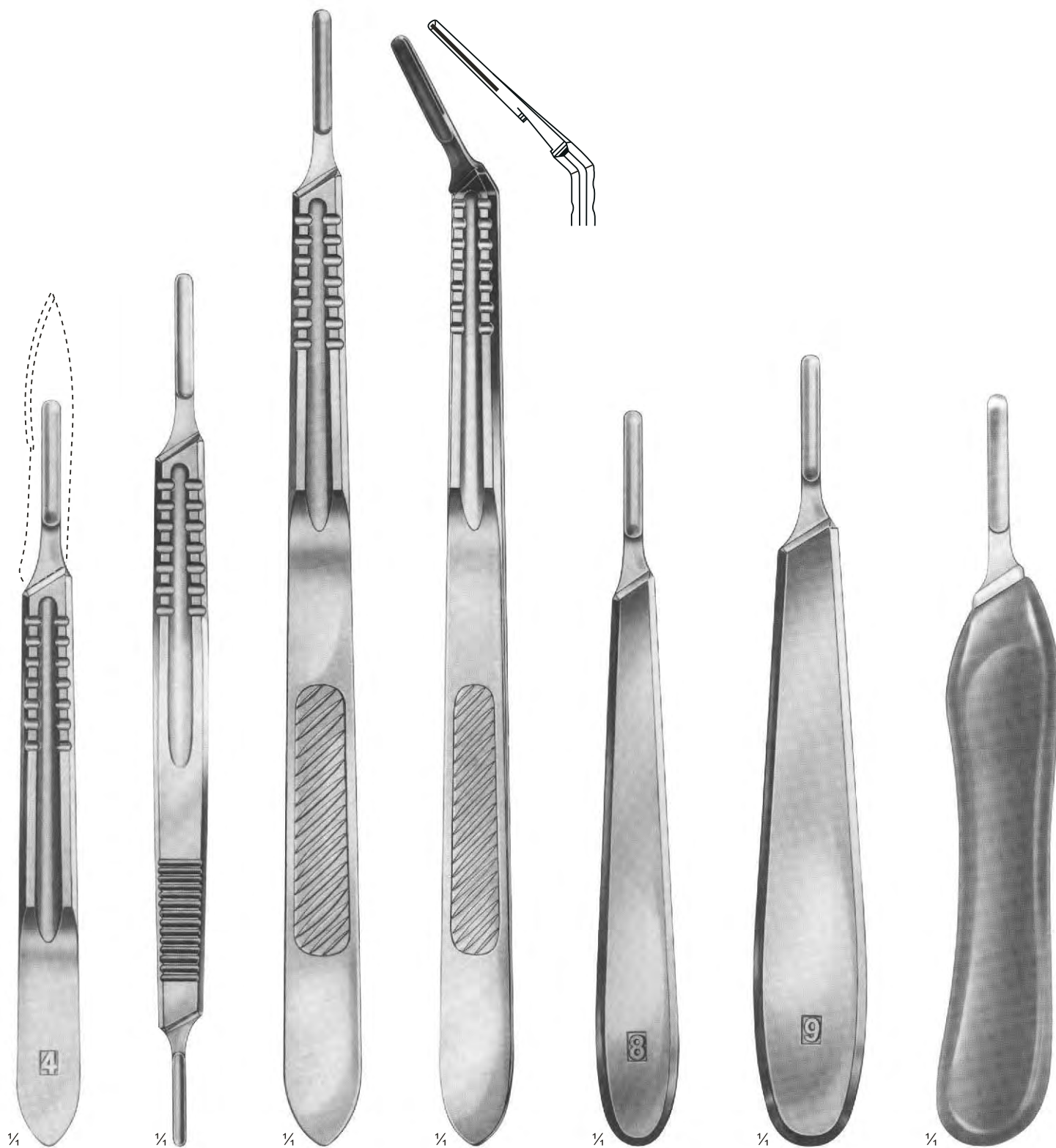

02-185
STANDARD
No. 4
Solid

02-186
Double Handel
No. 4 + No. 3
Solid

02-187
No. 4 L
Straight
Solid

02-188
No. 4 L
Solid Angled

02-189
COLLIN
No. 8
Hollow

02-190
COLLIN
No. 9
Hollow

02-191
Plastic

Scalpel Handles

REALSTAR SURGICAL INSTRUMENTS

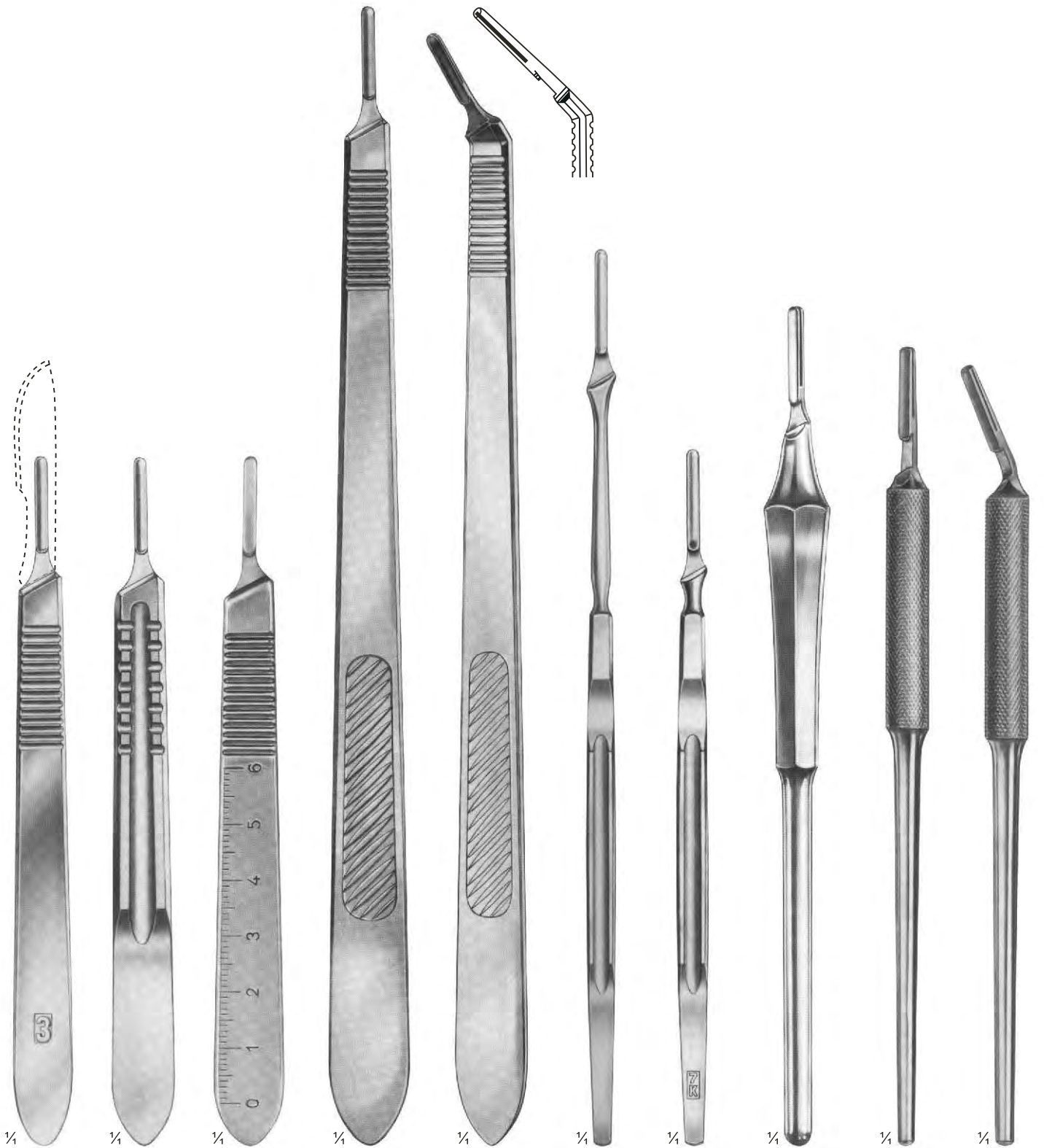

02-192 STANDARD No. 3 Solid	02-193 No. 3 Solid	02-194 No. 3 Solid	02-195 No. 3 L Straight Solid	02-196 No. 3 L Angled Solid	02-197 No. 7 Solid	02-198 No. 7 K Solid	02-199 Hollow-Round	02-200 No. 3 Straight Solid	02-201 No. 3 Angled Solid
---	---------------------------------	---------------------------------	---	---	---------------------------------	-----------------------------------	-------------------------------	---	---

Micro Scissors, "Spring Type" Flat Handles

REALSTAR SURGICAL INSTRUMENTS

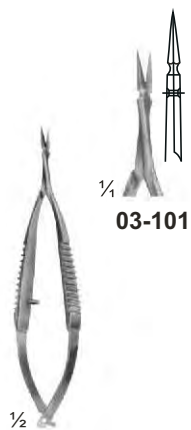

03-101 - 103
VANNAS
Size: 85 mm



03-104 - 105
CASTROVIEJO
Size: 95 mm



03-105

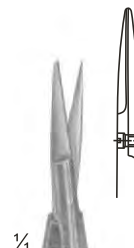

03-106
NOYES
Size: 125 mm

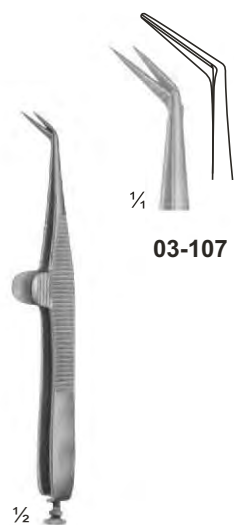

03-107 - 108
WECKER
Eye Scissor
Size: 110 mm

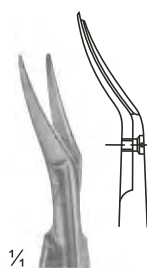
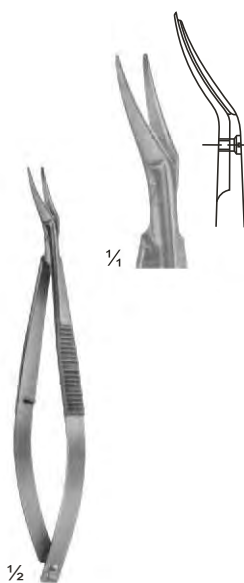

03-109
CASTROVIEJO
Eye Scissor
Size: 115 mm



03-110 - 111
CASTROVIEJO
Eye Scissor
Size: 110 mm

Micro Scissors, "Spring Type" Flat Handles

REALSTAR SURGICAL INSTRUMENTS

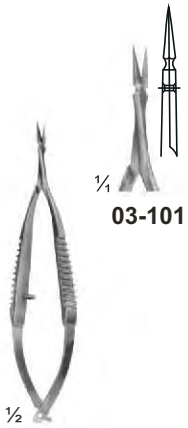

1/4
03-101



03-102



03-103

03-101 - 103
VANNAS
Size: 85 mm



1/4
03-104



03-105

03-104 - 105
CASTROVIEJO
Size: 95 mm

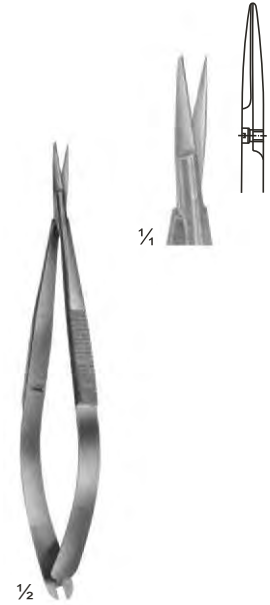

1/4

03-106
NOYES
Size: 125 mm

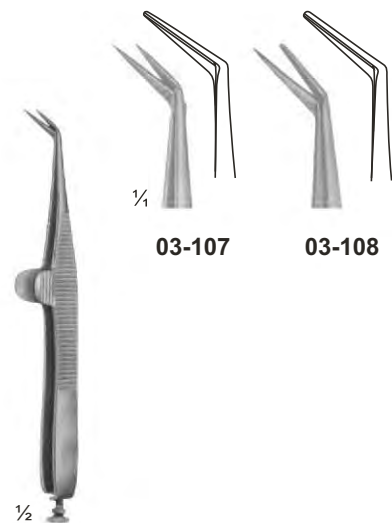

1/4
03-107

03-108

03-107 - 108
WECKER
Eye Scissor
Size: 110 mm

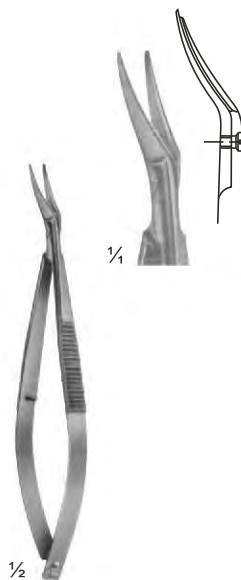

1/4

03-109
CASTROVIEJO
Eye Scissor
Size: 115 mm

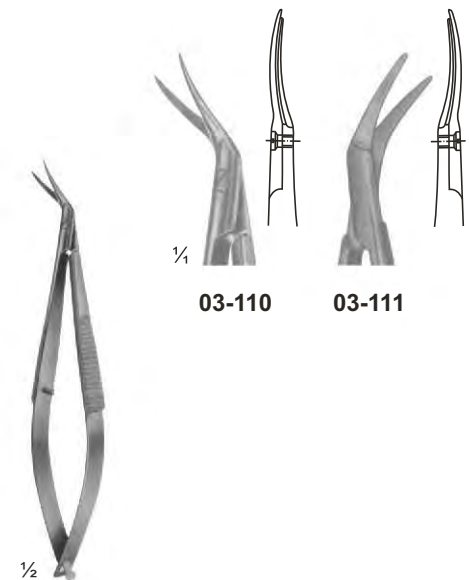

1/4
03-110

03-111

03-110 - 111
CASTROVIEJO
Eye Scissor
Size: 110 mm

Micro Scissors, "Spring Type" Flat Handles

REALSTAR SURGICAL INSTRUMENTS

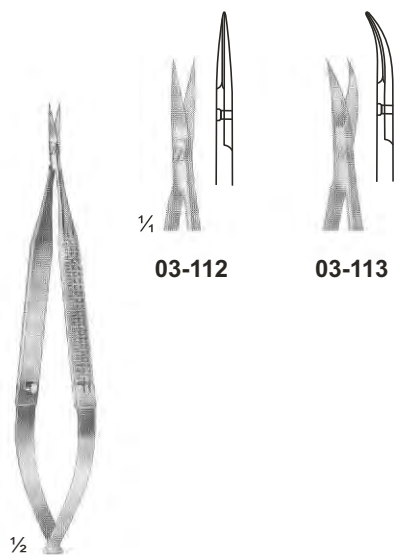

03-112
03-113

03-112 - 113
Size: 120 mm

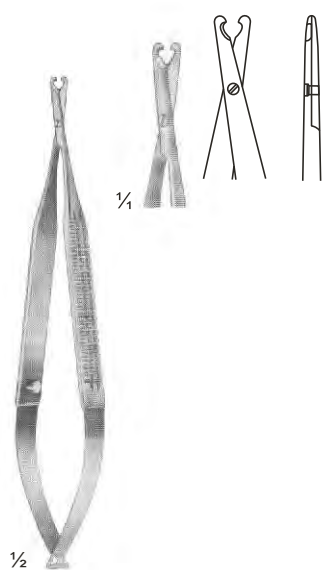

03-114
03-115

03-114
BIEMER
Vein Scissor
Size: 130 mm

03-115
Size: 160 mm

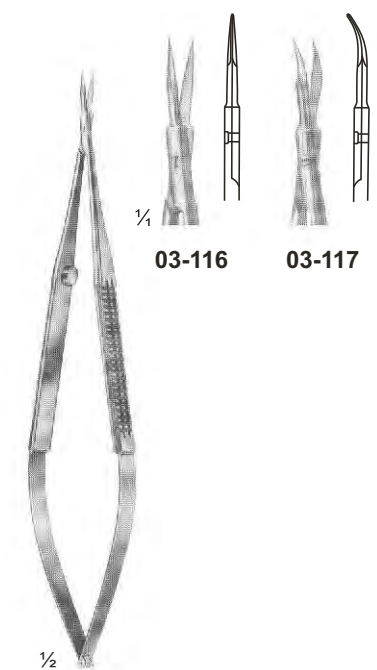

03-116
03-117

03-116 - 117
VANNAS
Size: 160 mm

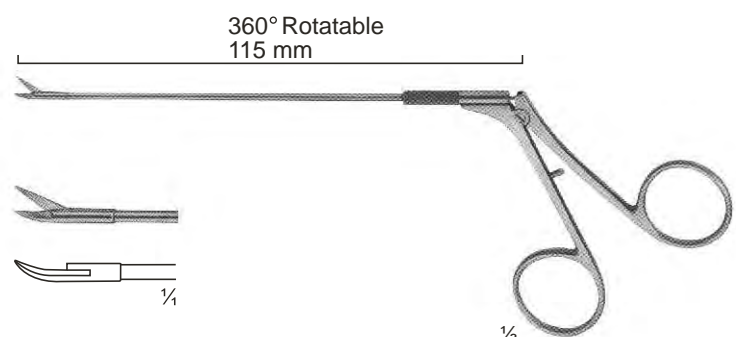

03-118
CASPAR
Micro Scissor Curved
Size: 115 mm

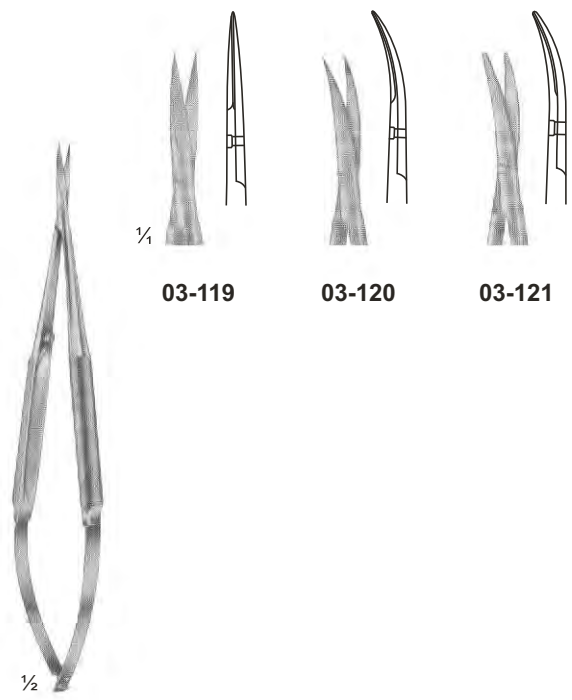

03-119
03-120
03-121

03-119 - 121
Micro Dissecting Scissor
Size: 145 mm

Micro Scissors, "Spring Type" Bayonet Shape

REALSTAR SURGICAL INSTRUMENTS

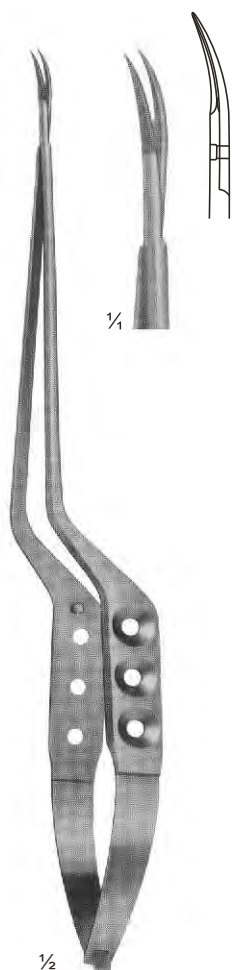

03-122
YASARGIL
Size: 245 mm

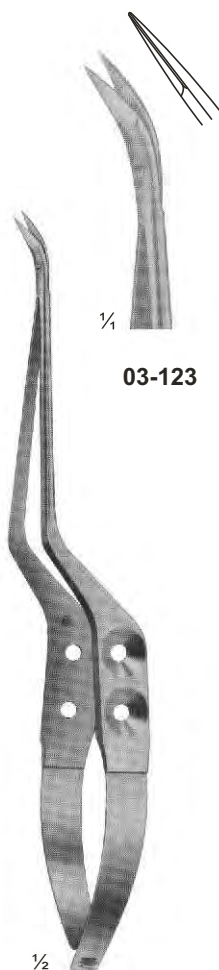

03-123

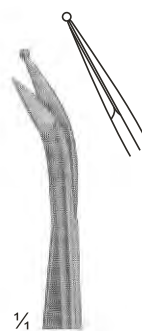

03-124

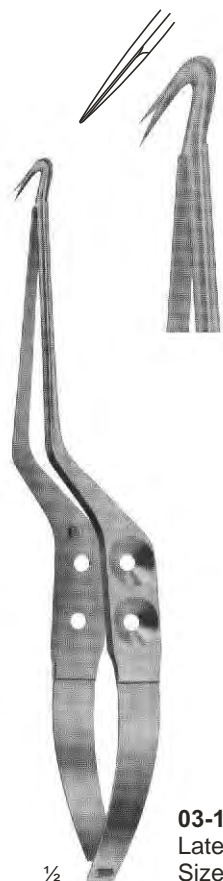

03-125
Laterally Angled
Size: 190 mm

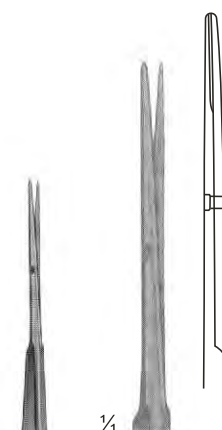

03-126

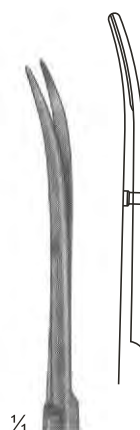

03-127



03-126 - 127
YASARGIL
Size: 225 mm

Delicate Scissors

REALSTAR SURGICAL INSTRUMENTS

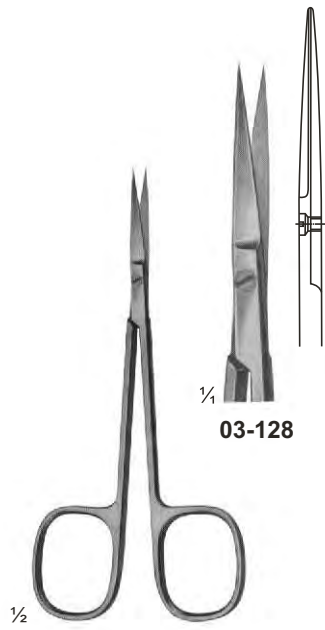

1/4
03-128

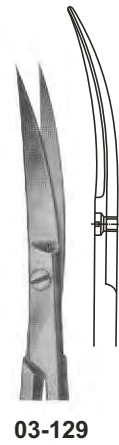

03-129

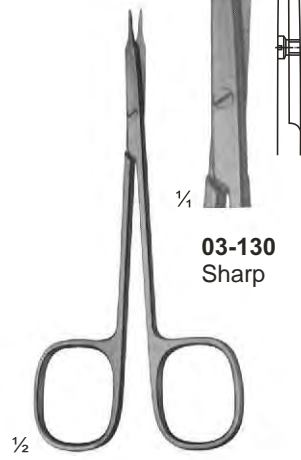

1/4
03-130
Sharp

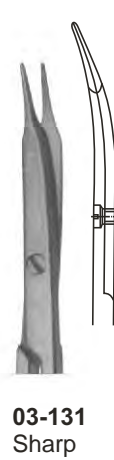

03-131
Sharp



03-132
Blunt

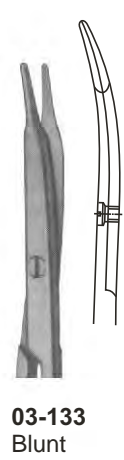

03-133
Blunt

03-128 - 129
Size: 120 mm

03-130 - 133
STEVENS
Dissecting Scissors
Size: 115 mm

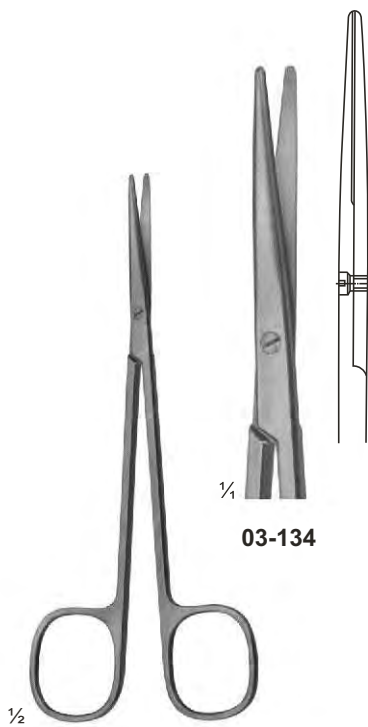

1/4
03-134

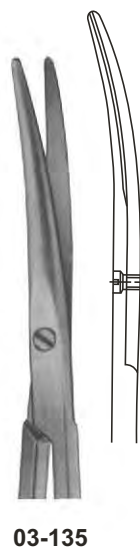

03-135

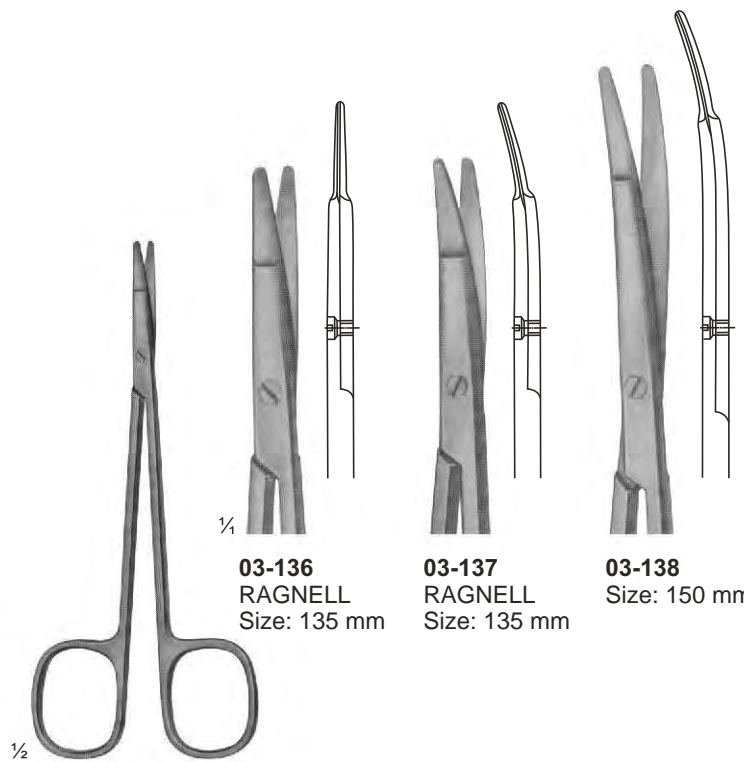

1/4
03-136
RAGNELL
Size: 135 mm

03-137
RAGNELL
Size: 135 mm

03-138
Size: 150 mm

03-134 - 135
METZENBAUM
Dissecting Scissors
Size: 145 mm

03-136 - 138
Special flat points for
dissecting and
undermining the skin
Size: 145 mm

Delicate Scissors

REALSTAR SURGICAL INSTRUMENTS

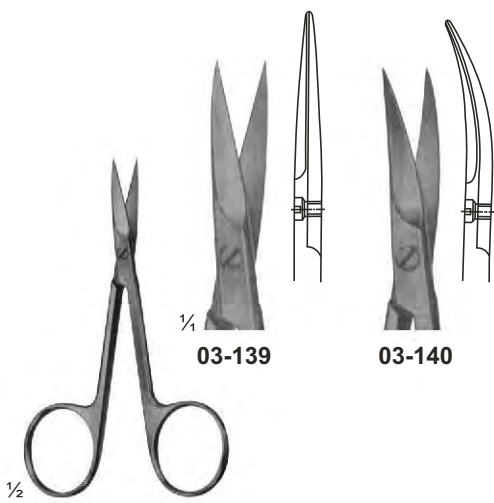

03-139

03-140

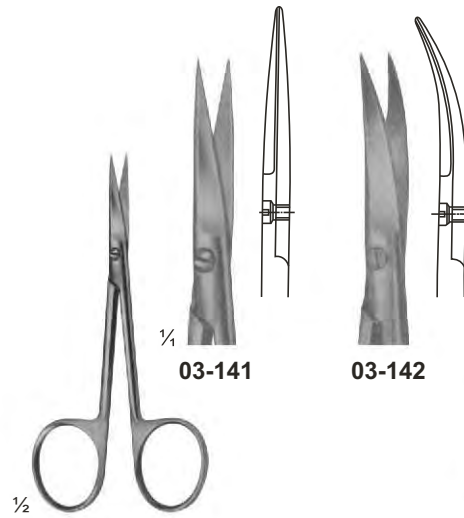

03-141

03-142

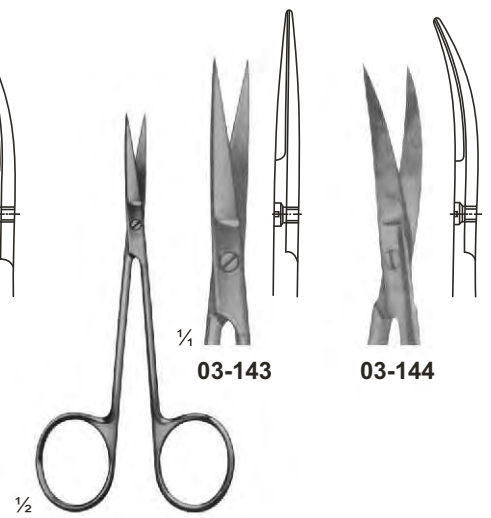

03-143

03-144

03-139 - 140
Size: 90 mm

03-141 - 142
Size: 95 mm

03-143 - 144
Size: 105 mm

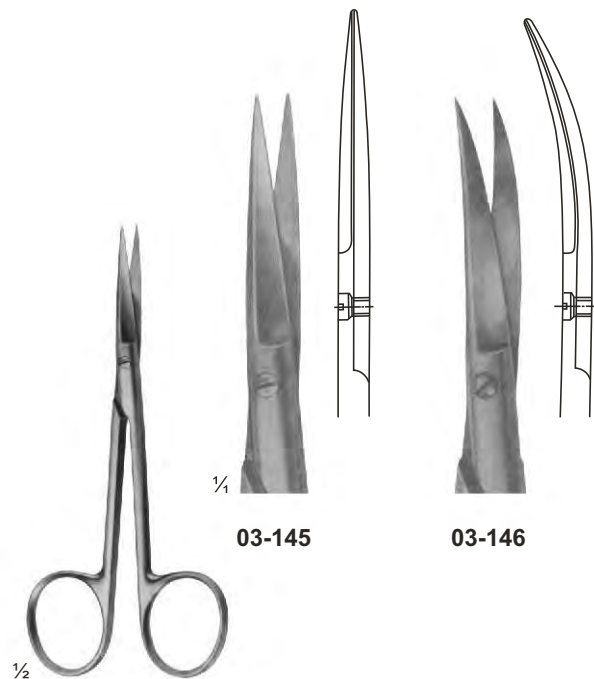

03-145

03-146

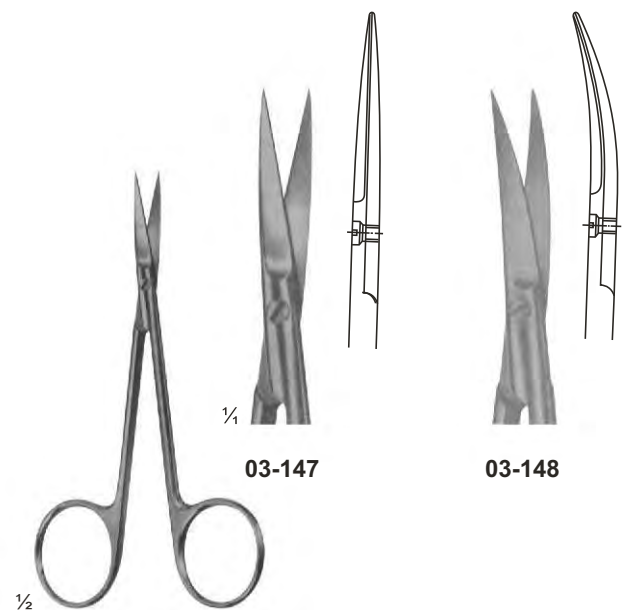

03-147

03-148

03-145 - 146
Size: 120 mm

03-147 - 148
Size: 115 mm

Delicate Scissors

REALSTAR SURGICAL INSTRUMENTS

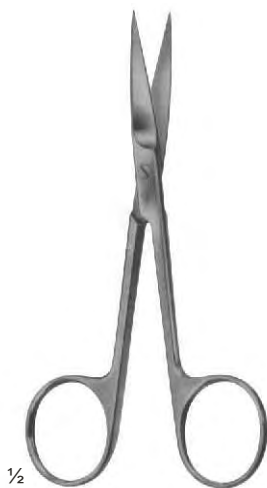

1/2

03-149 - 151
Size: 120 mm

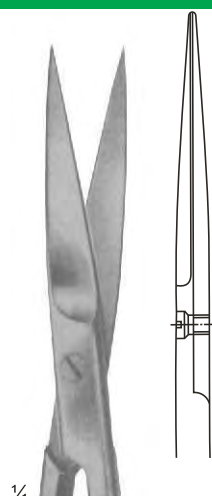

1/4

03-149

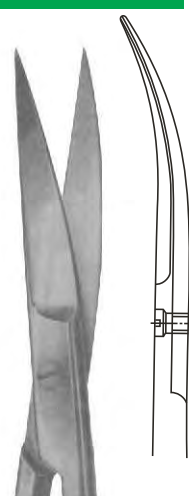

03-150

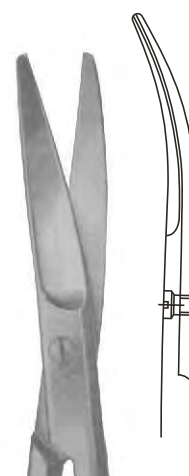

03-151



1/2

03-152 - 155
Size: 130 mm

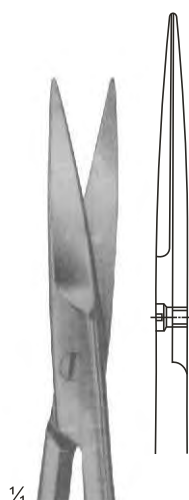

1/4

03-152

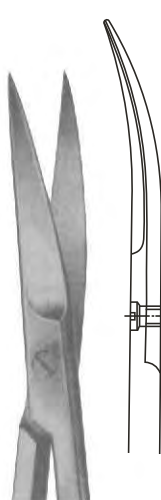

03-153

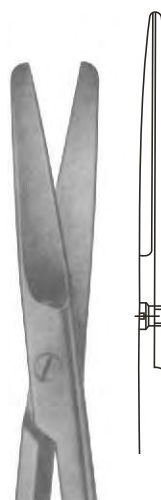

03-154

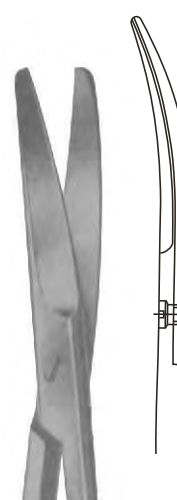

03-155

Delicate Scissors

REALSTAR SURGICAL INSTRUMENTS

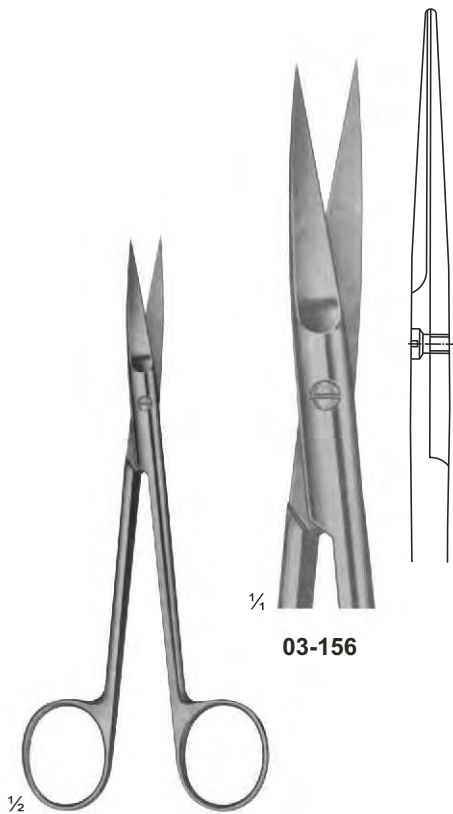

03-156

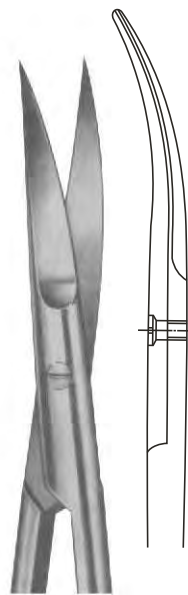

03-157

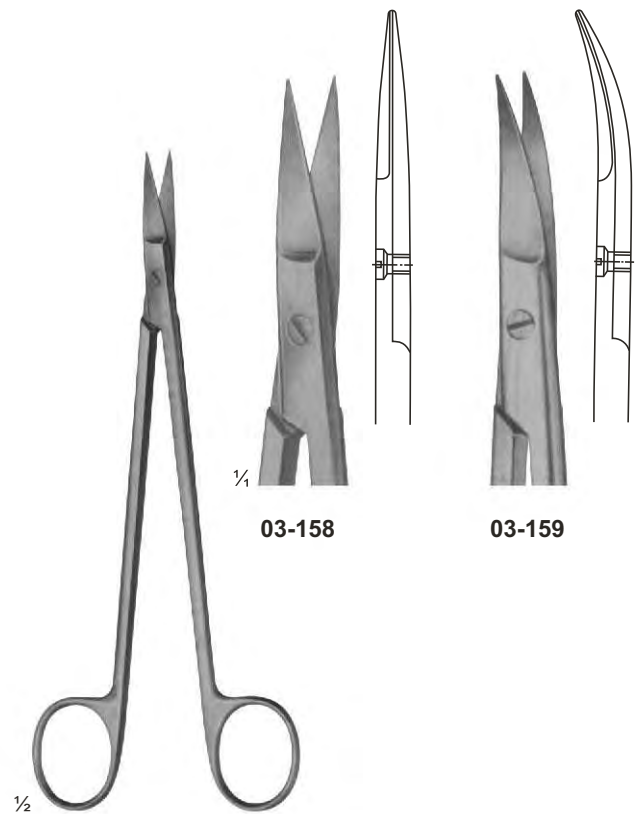

03-158

03-159

03-156 - 157
JOSEPH
Size: 150 mm

03-158 - 159
KELLY
Size: 175 mm

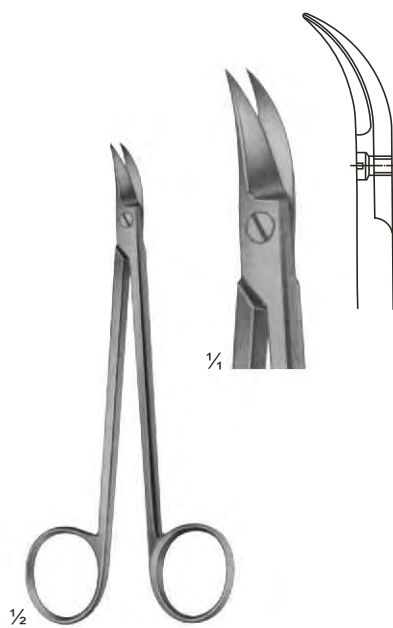

03-160
QUINBY
Size: 130 mm

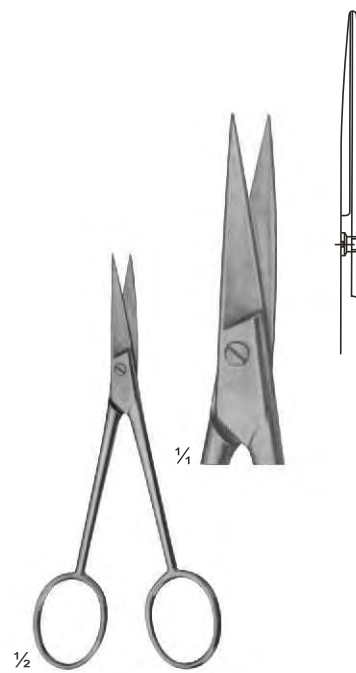

03-161
Size: 110 mm

Surgical Scissors

REALSTAR SURGICAL INSTRUMENTS

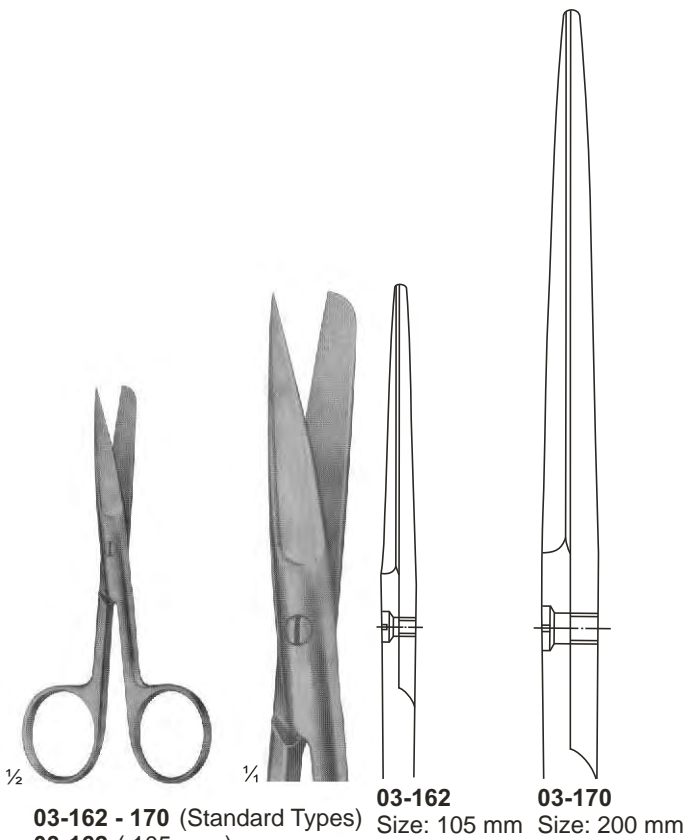

03-162 - 170 (Standard Types)
03-162 (105 mm)
03-163 (115 mm)
03-164 (130 mm)
03-165 (145 mm)
03-166 (150 mm)
03-167 (165 mm)
03-168 (175 mm)
03-169 (185 mm)
03-170 (200 mm)

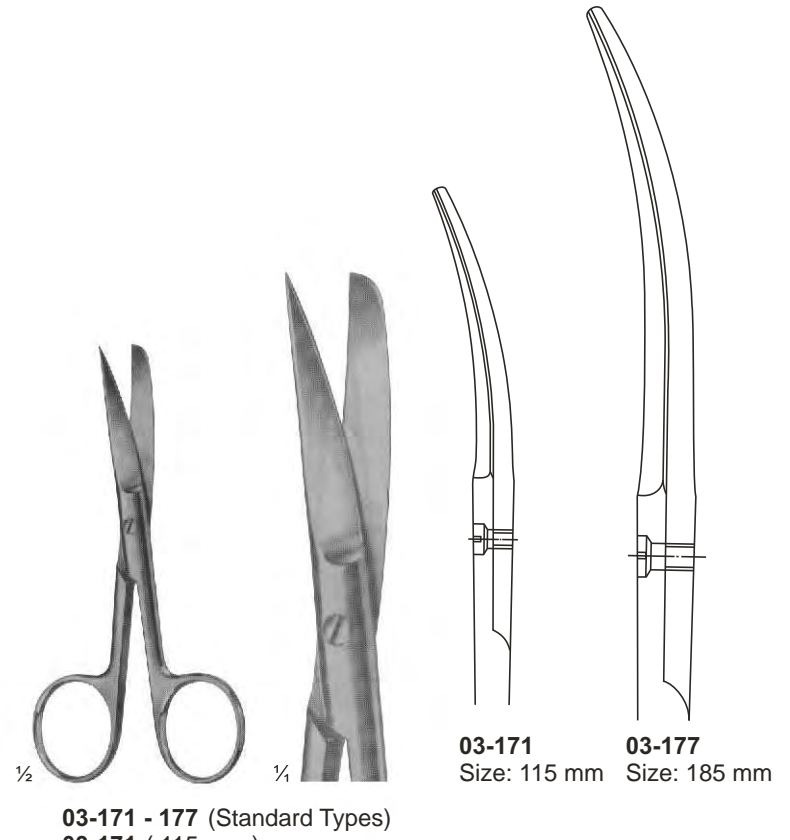

03-171 - 177 (Standard Types)
03-171 (115 mm)
03-172 (130 mm)
03-173 (145 mm)
03-174 (150 mm)
03-175 (165 mm)
03-176 (175 mm)
03-177 (185 mm)

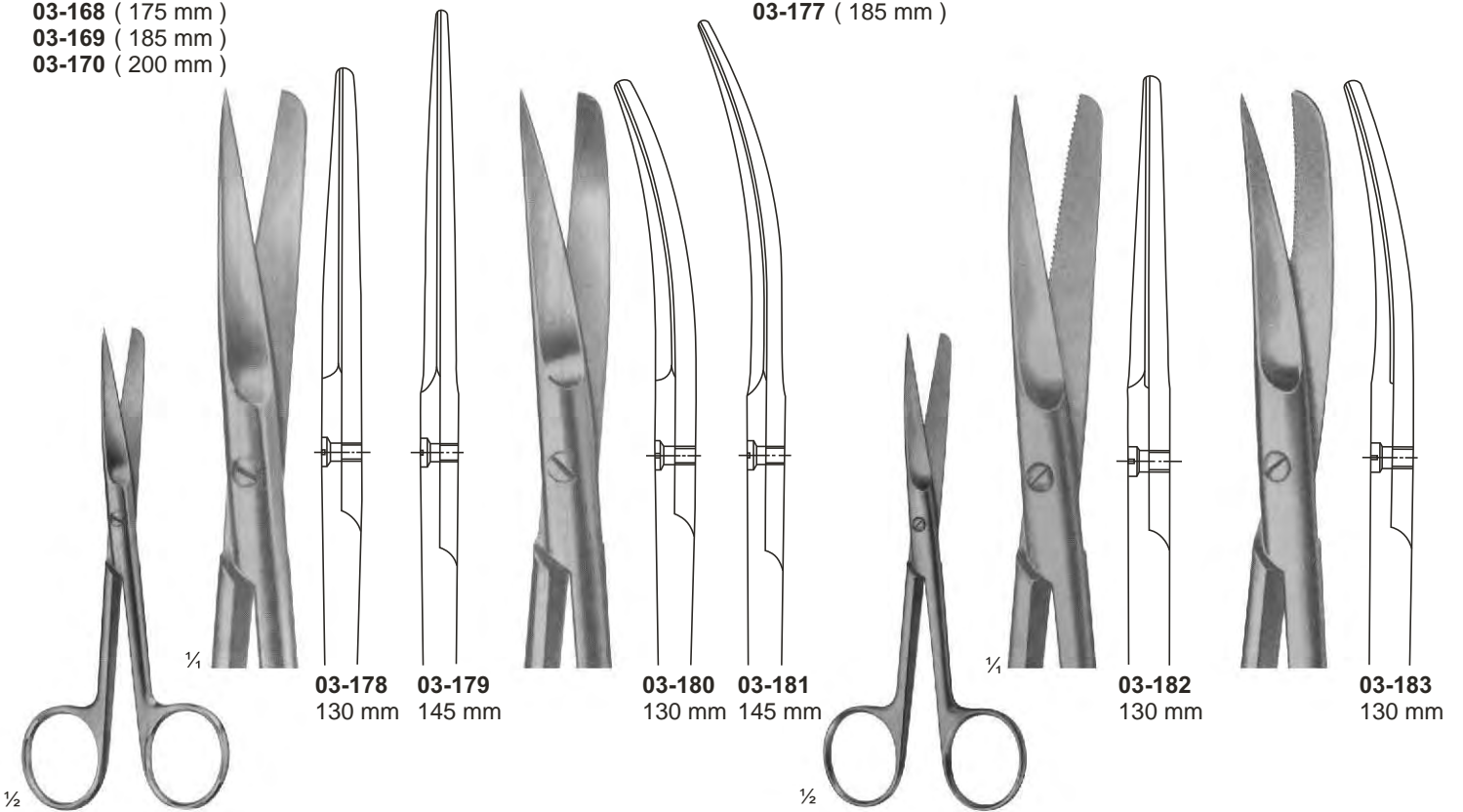

03-178 - 181
Slender Types

03-182 - 183
For Wound Edges
1 Blade Serrated

Surgical Scissors

REALSTAR SURGICAL INSTRUMENTS

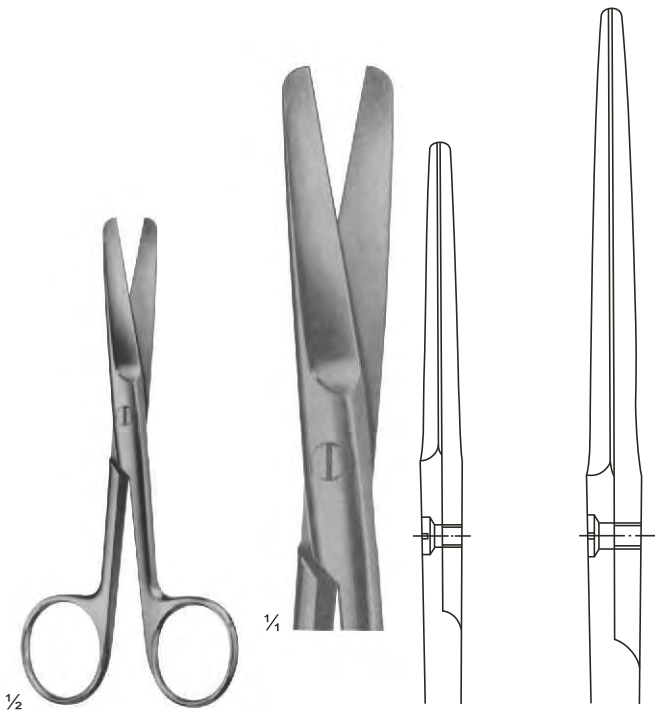

03-184 - 188 (Standard Types)
03-184 (130 mm)
03-185 (145 mm)
03-186 (150 mm)
03-187 (165 mm)
03-188 (175 mm)



03-189 - 194 - COOPER
 Standard Types
03-189 (115 mm)
03-190 (130 mm)
03-191 (145 mm)
03-192 (150 mm)
03-193 (165 mm)
03-194 (175 mm)

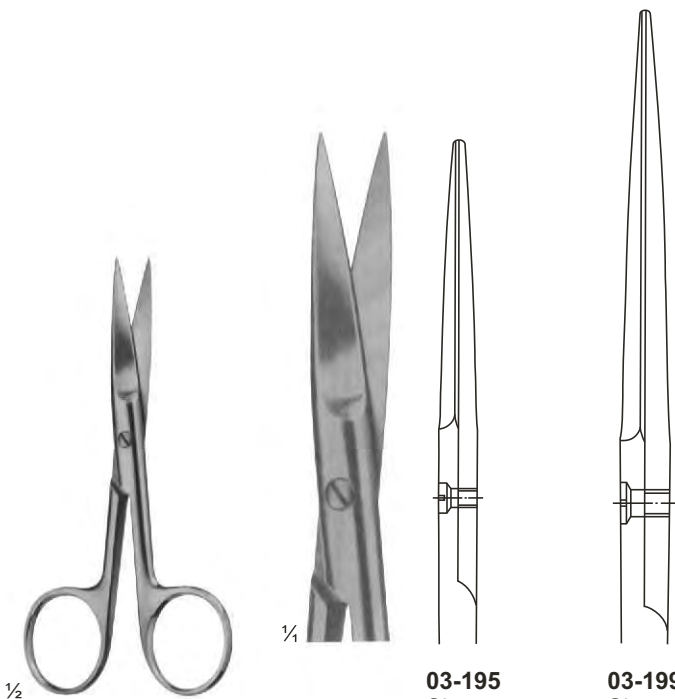

03-195 - 199
 Standard Types
03-195 (115 mm)
03-196 (130 mm)
03-197 (145 mm)
03-198 (150 mm)
03-199 (165 mm)

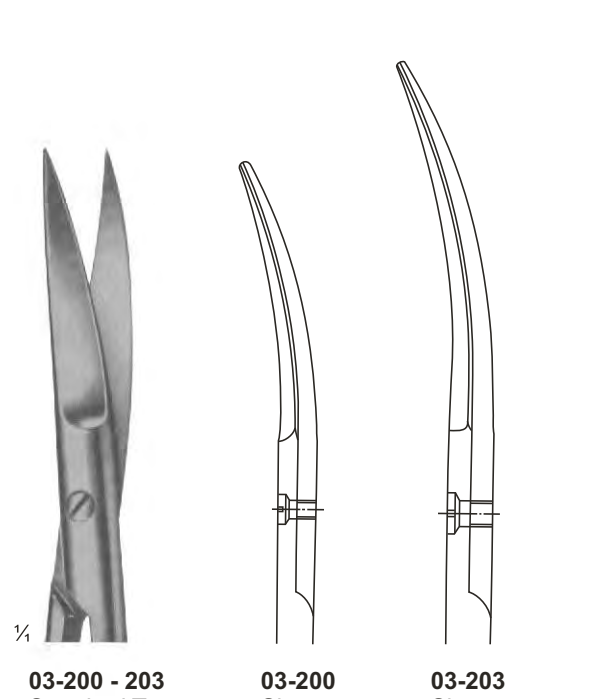

03-200 - 203
 Standard Types
03-200 (115 mm)
03-201 (130 mm)
03-202 (145 mm)
03-203 (150 mm)

Surgical Scissors

REALSTAR SURGICAL INSTRUMENTS

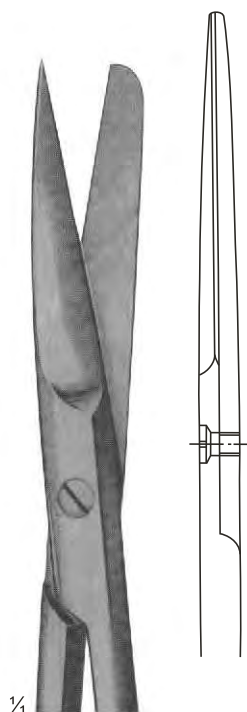
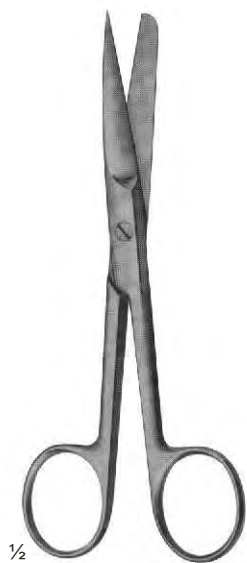

03-204
Size: 145 mm

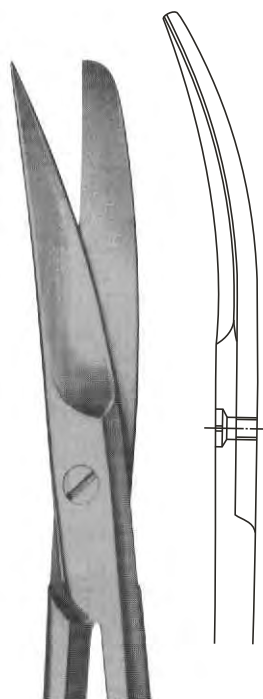

03-205
Size: 145 mm

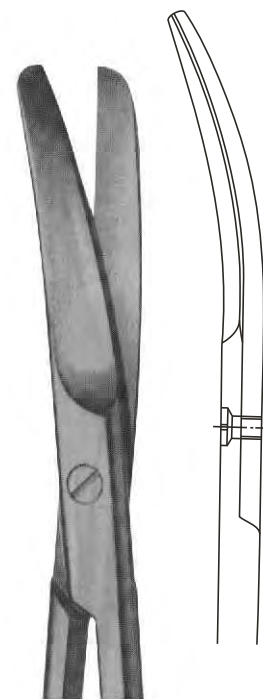

03-206
Size: 145 mm

03-204 - 206
DEAVER
With flat lock

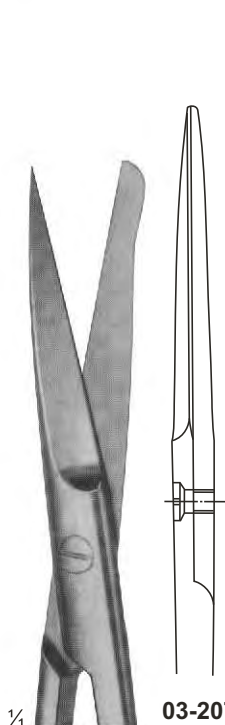

03-207
Size: 130 mm

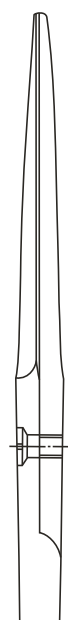

03-208
Size: 145 mm

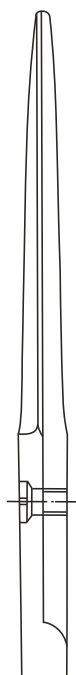

03-209
Size: 165 mm

03-207 - 209
Incision Scissors

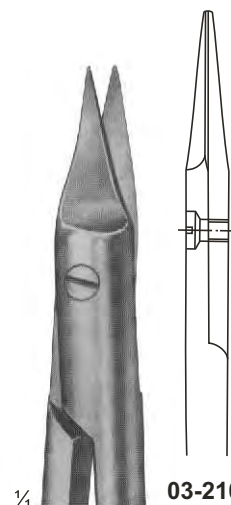
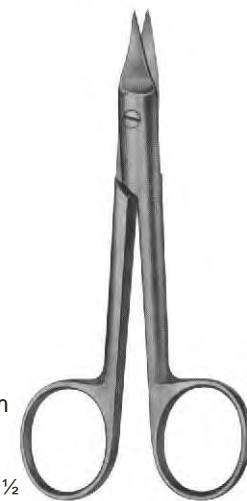

03-210
Size: 130 mm

03-210
SYSTRUNK
Nail Splitting Scissors

Dissecting Scissors

REALSTAR SURGICAL INSTRUMENTS

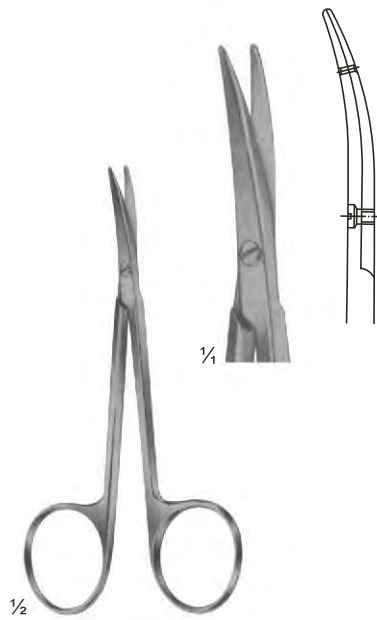

03-211
LITTLER
Dissecting Scissors
Tips with eye for suture
Size: 115 mm

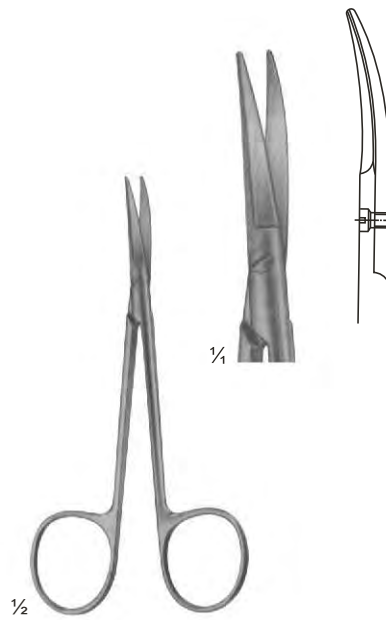

03-212
COTTLE
Bulldog Scissors
Size: 115 mm



03-213 **03-214**
Size: 100 mm Size: 100 mm

03-213 - 214
STEVENS
Vessel and tendon Scissors
Size: 100 mm

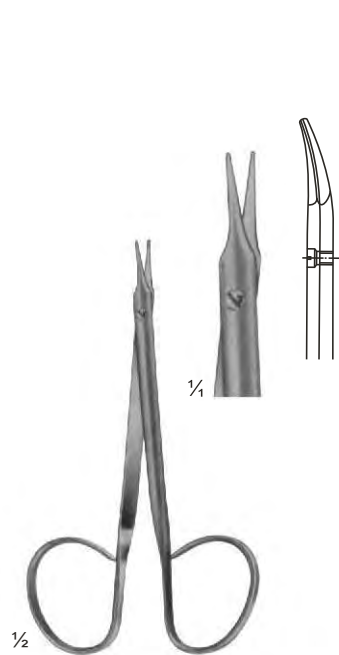

03-215
STEVENS
Fine Dissecting Scissors
Size: 110 mm

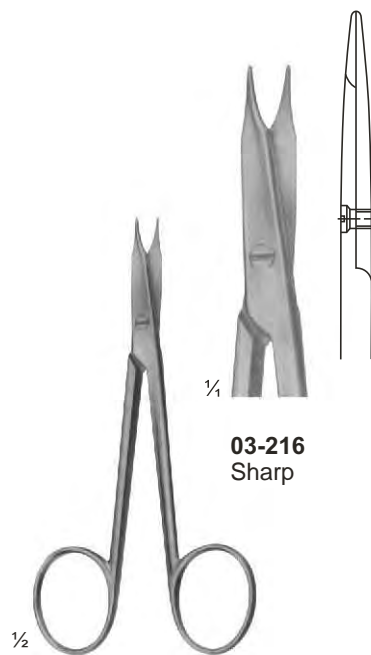

03-216 - 219
STEVENS
Vessel and tendon Scissors
Size: 110 mm

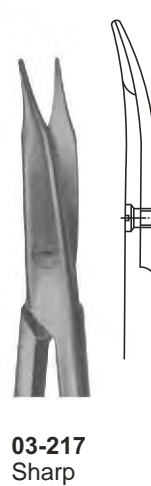

03-217
Sharp

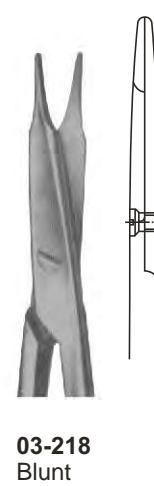

03-218
Blunt

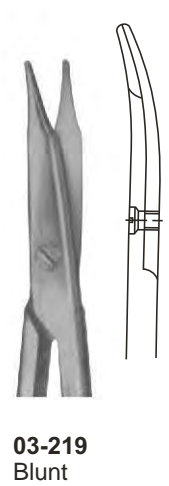

03-219
Blunt

Dissecting Scissors

REALSTAR SURGICAL INSTRUMENTS

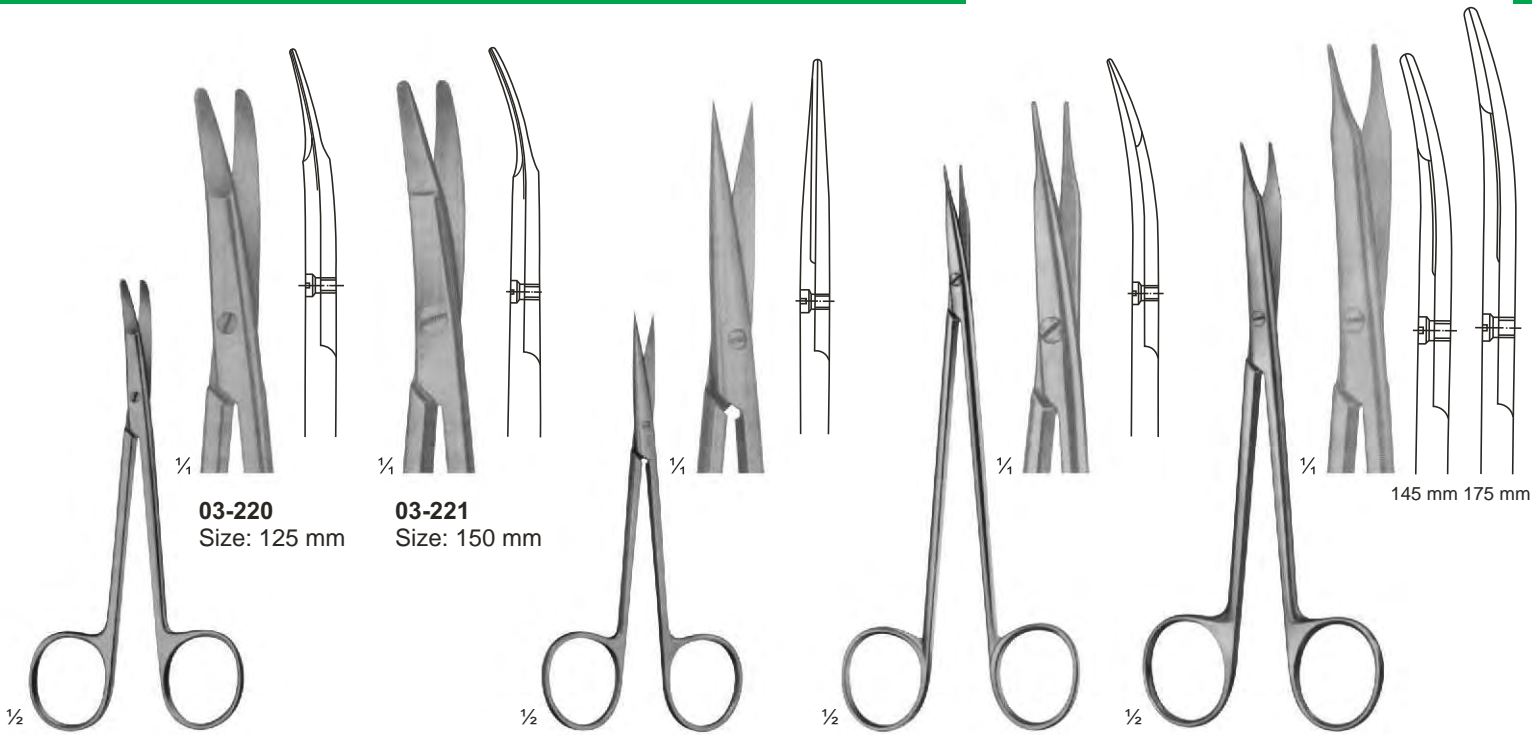

03-220 - 221
KILNER
Special flat points for dissecting and undermining the skin

03-222
KILNER
Fine dissecting scissors
Size: 115 mm

03-223
JAMESON
Dissecting scissors
Size: 150 mm

03-224
REYNOLDS
Dissecting scissors
Size: 145 - 175 mm

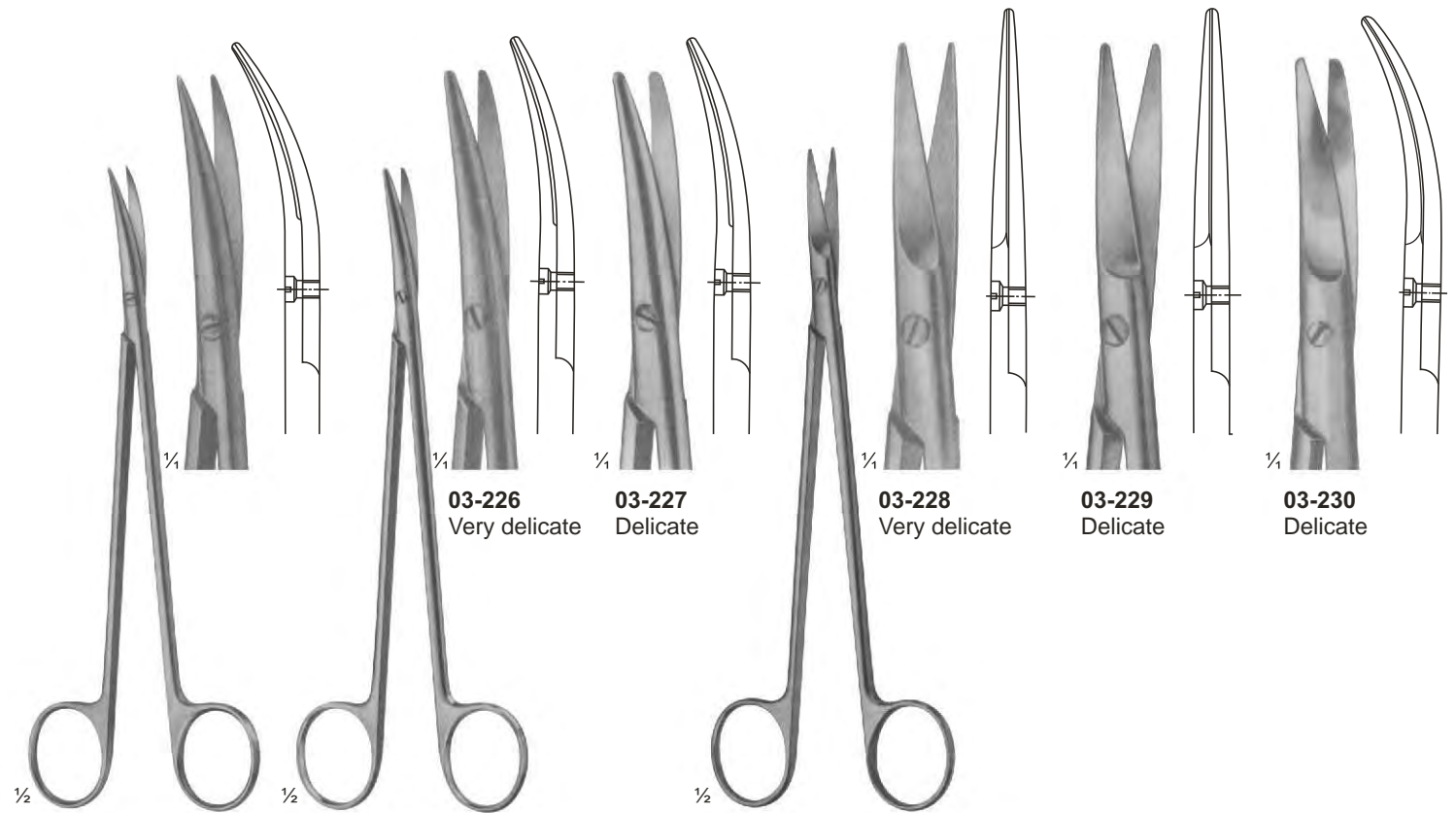

03-225
DE BAKEY
Ateriotomy scissors
Size: 175 mm

03-226 - 227
TOENNIS ADSON
Dissecting scissors
Size: 175 mm

03-228 - 230
TOENNIS
Dissecting scissors
Size: 150 mm

Dissecting & Surgical Scissors

REALSTAR SURGICAL INSTRUMENTS



03-231
Size: 115 mm

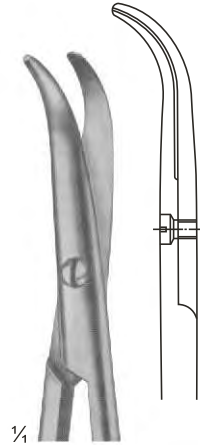

03-232
Size: 135 mm

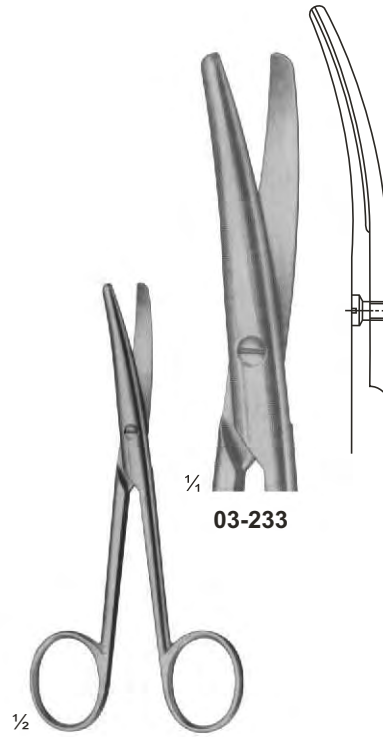

03-233

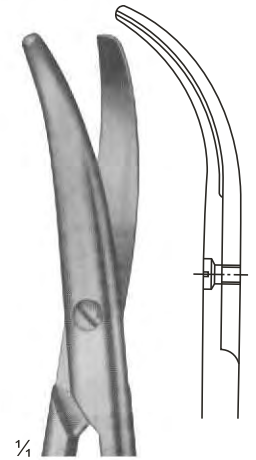

03-234

03-231 - 232
FOMON
Lower lateral scissors

03-233 - 234
LANDOLT
Enucleation scissors
Size: 120 mm

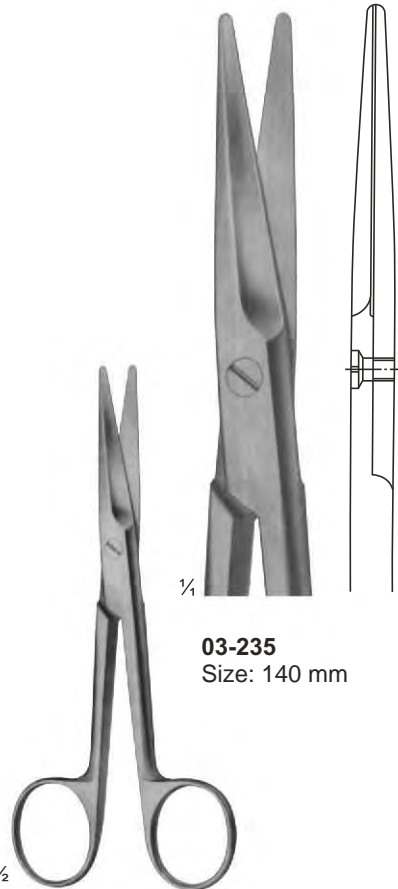

03-235
Size: 140 mm

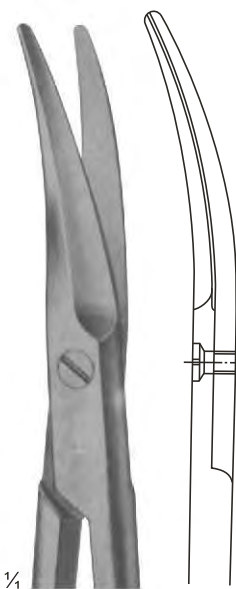

03-238 - 240
MAYO
03-238 (140 mm)
03-239 (155 mm)
03-240 (170 mm)

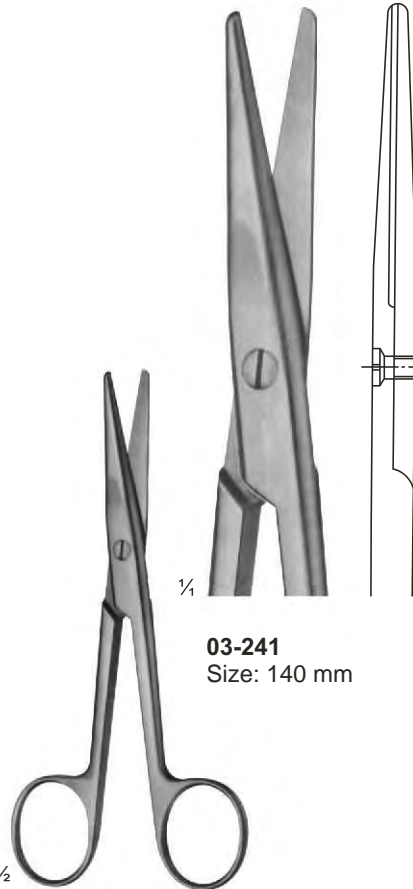

03-241
Size: 140 mm

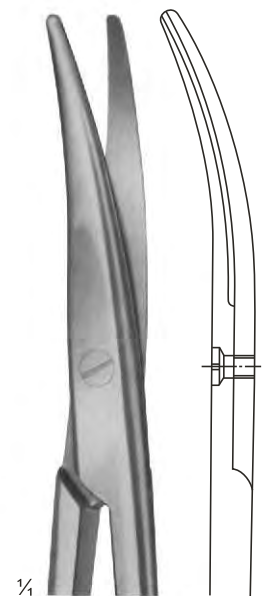

03-243 - 244
MAYO-STILLE
03-243 (140 mm)
03-244 (170 mm)

03-235 - 237
MAYO
03-235 (140 mm)
03-236 (155 mm)
03-237 (170 mm)

03-241 - 242
MAYO-STILLE
03-241 (140 mm)
03-242 (170 mm)

Dissecting Scissors

REALSTAR SURGICAL INSTRUMENTS

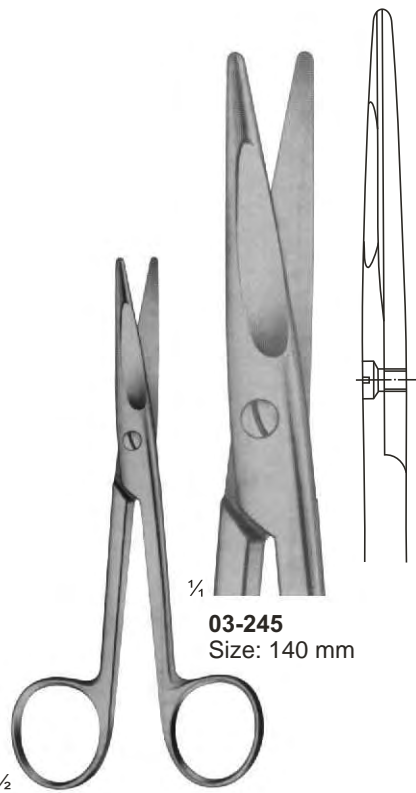

03-245
Size: 140 mm

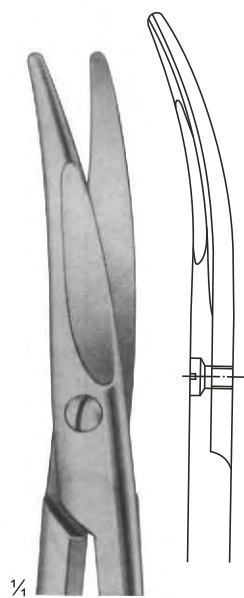

MAYO-STILLE
03-247 - 248
Size: 140 mm
03-248
Size: 170 mm

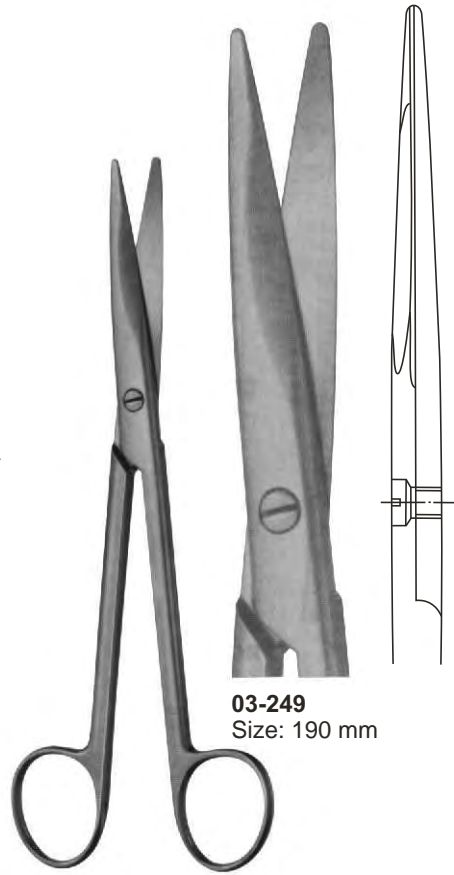

03-249
Size: 190 mm

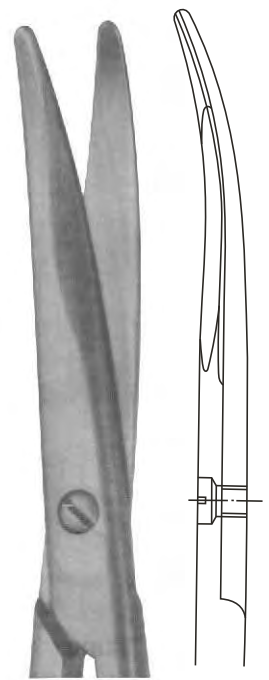

MAYO
03-251
Size: 190 mm
03-252
Size: 215 mm

1/2
03-245 - 246
MAYO-STILLE
With chamfered blades
03-245 (140 mm)
03-246 (170 mm)

MAYO
With chamfered blades
03-249 (190 mm)
03-250 (215 mm)



03-253
Size: 170 mm

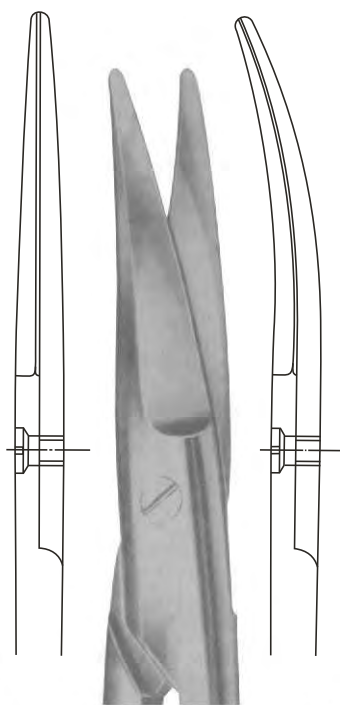

03-254
Size: 170 mm

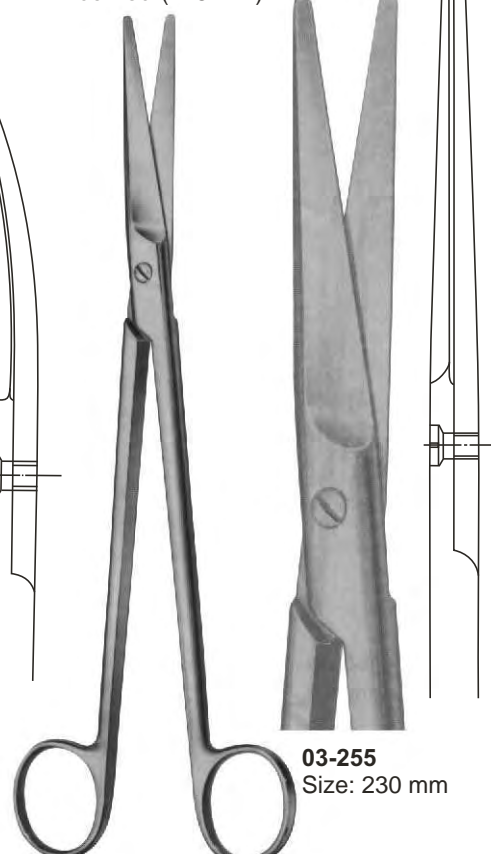

03-255
Size: 230 mm

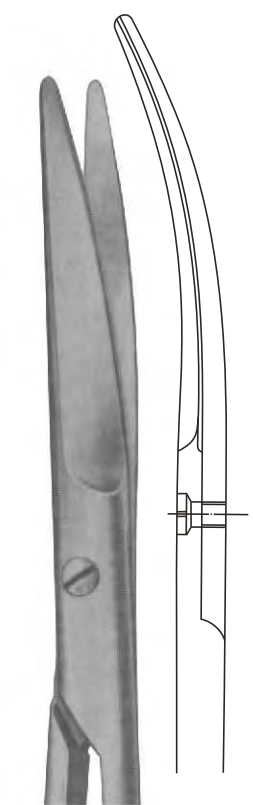

03-256
Size: 230 mm

03-253 - 254
MAYO-NOBLE

03-255 - 256
MAYO-HARRINGTON

Dissecting Scissors

REALSTAR SURGICAL INSTRUMENTS

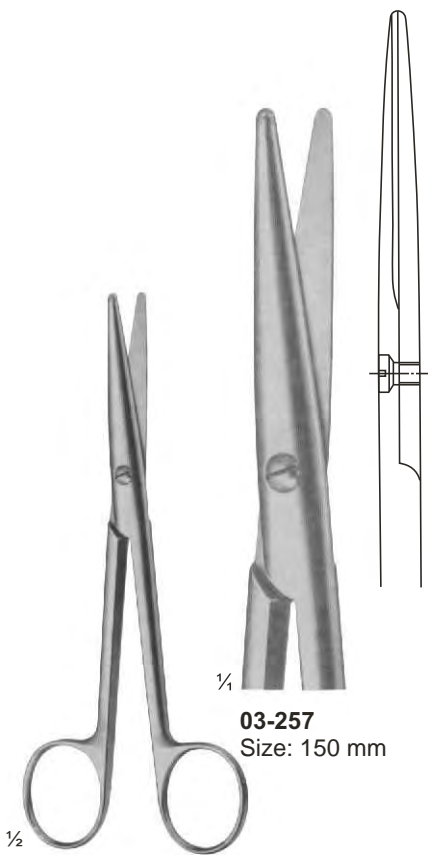

03-257
Size: 150 mm

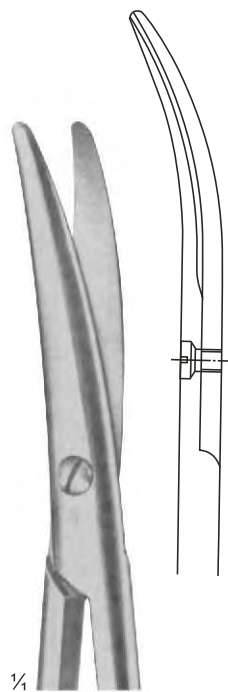

03-258
Size: 150 mm

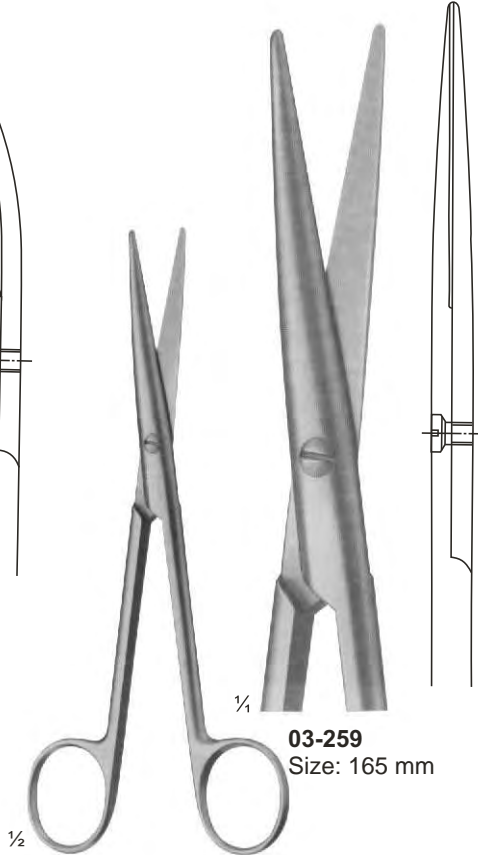

03-259
Size: 165 mm

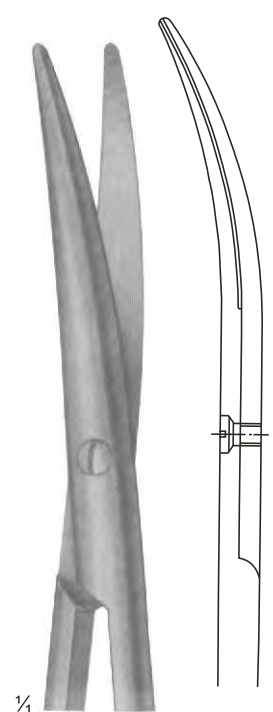

03-260
Size: 165 mm

03-257 - 258
STILLE
Size: 150 mm

03-259 - 260
LEXER
Narrow
Size: 165 mm

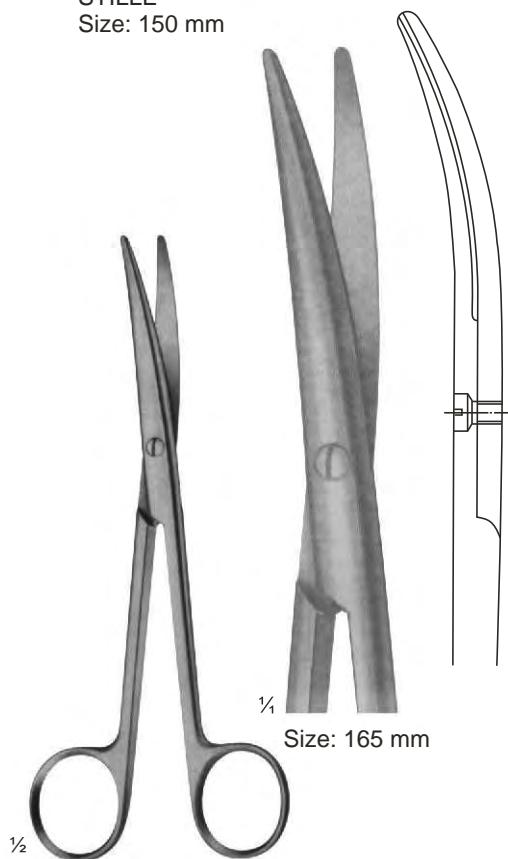

Size: 165 mm

03-261
MAYO-LEXER
Standard

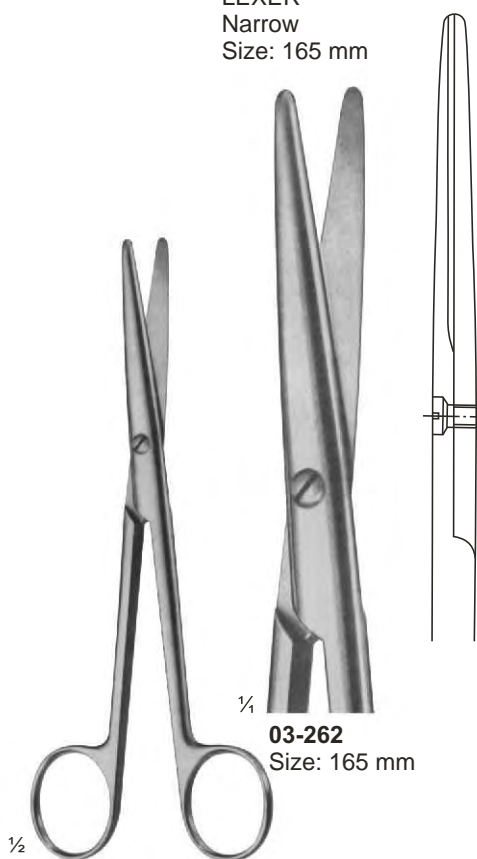

03-262
Size: 165 mm

03-262 - 263
MAYO
03-262 (165 mm)
03-263 (200 mm)

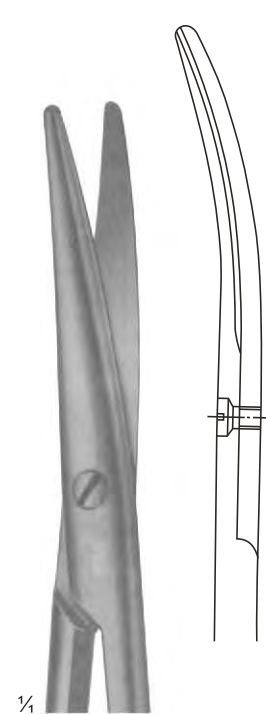

MAYO
03-264 - 266
Size: 165 mm

03-265
Size: 200 mm
03-266
Size: 210 mm

Dissecting Scissors

REALSTAR SURGICAL INSTRUMENTS

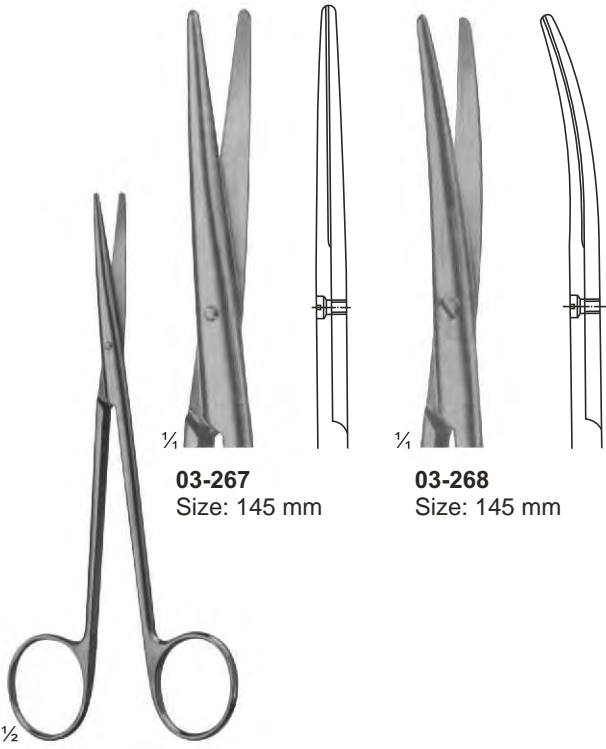

03-267
Size: 145 mm

03-268
Size: 145 mm

03-267 - 268
BABY - METZENBAUM

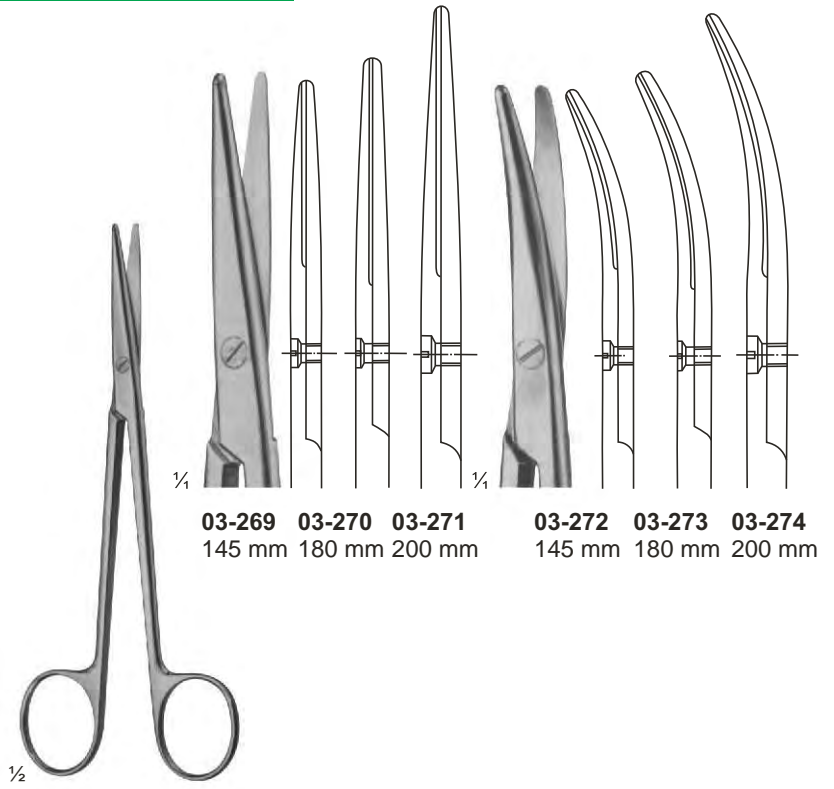

03-269 145 mm

03-270 180 mm

03-271 200 mm

03-272 145 mm

03-273 180 mm

03-274 200 mm

03-269 - 274
METZENBAUM



03-275 - 282

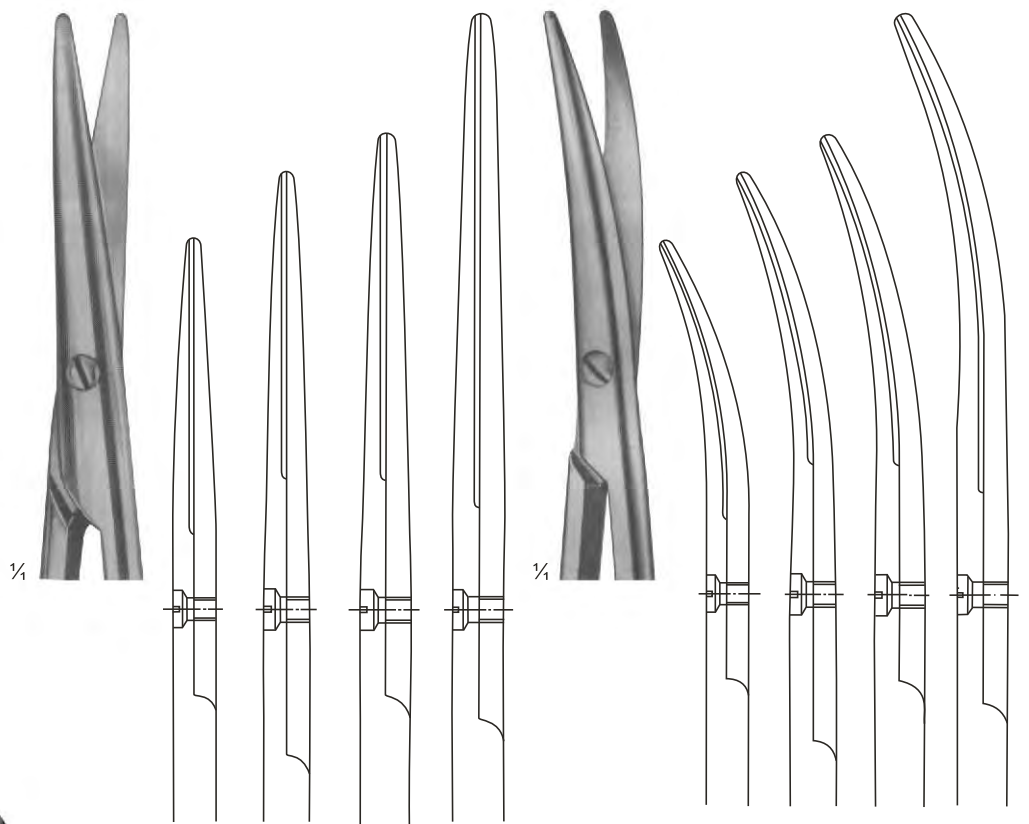

03-275 230 mm
03-276 250 mm
03-277 280 mm
03-278 305 mm

03-279 230 mm
03-280 250 mm
03-281 280 mm
03-282 305 mm

Vessel Scissors

REALSTAR SURGICAL INSTRUMENTS

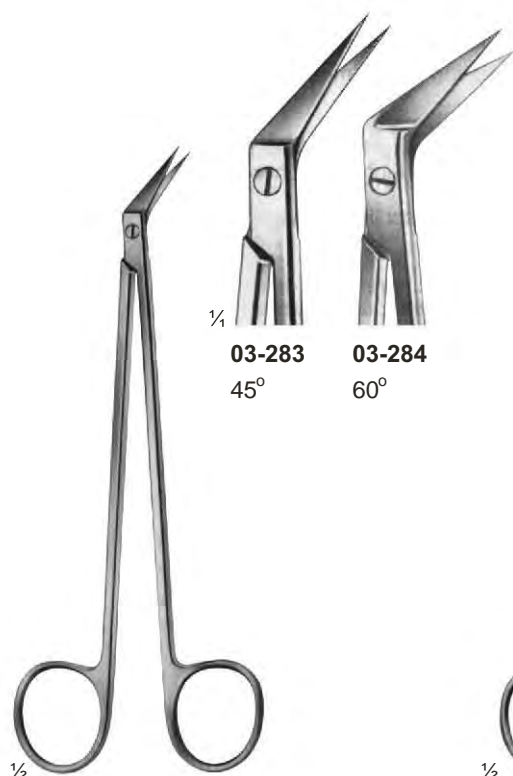

03-283
45°

03-284
60°

03-283 - 284
DE BAKEY
Size: 155 mm

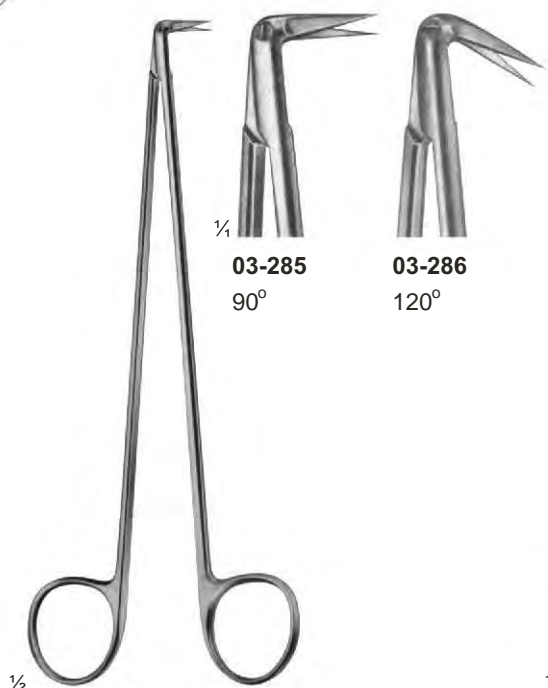

03-285
90°

03-286
120°

03-285 - 286
DIETRICH
Size: 170 mm

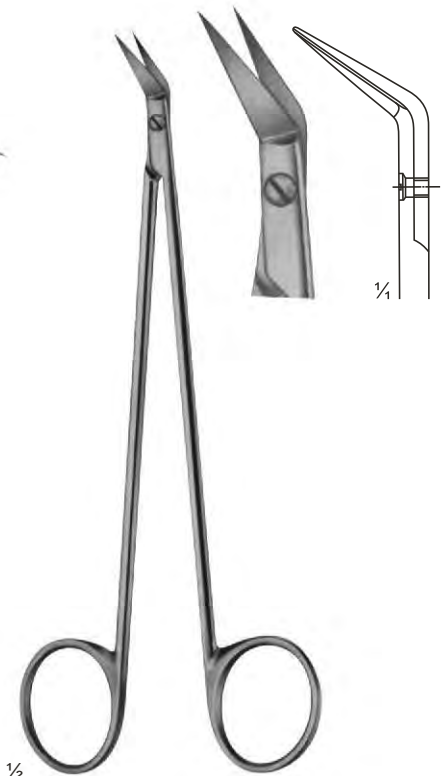

03-287
POTTS-SMITH
Size: 180 mm

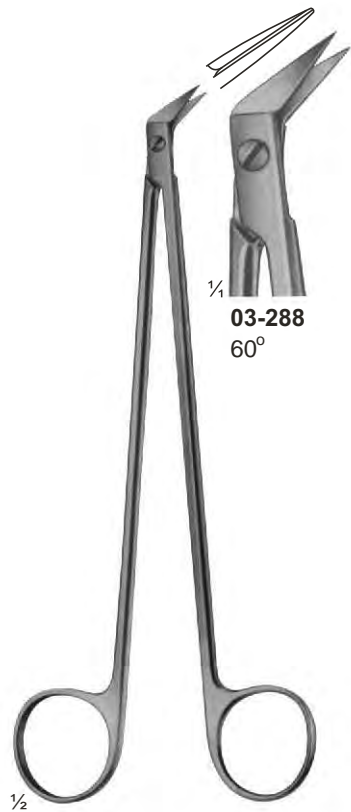

03-288
60°

03-288
POTTS-SMITH
Size: 180 mm

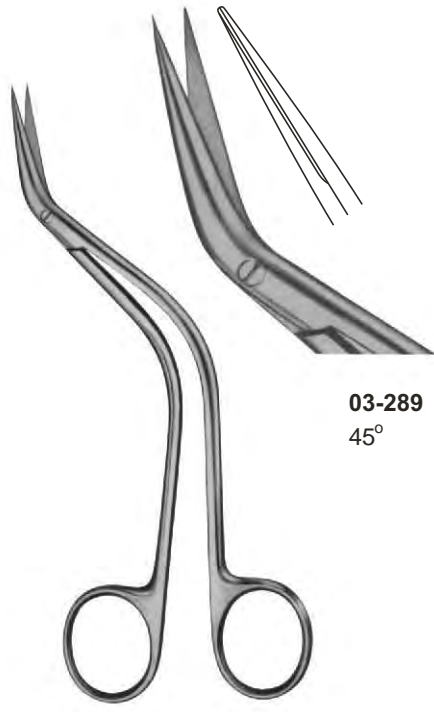

03-289
45°

03-289
DEBAKEY
Size: 155 mm



03-290
55°

03-290
FAVOLORO
Size: 140 mm

Cardiovascular and Neuro-Surgery Scissors

REALSTAR SURGICAL INSTRUMENTS



03-291
OLIVECRONA
Dura Scissors

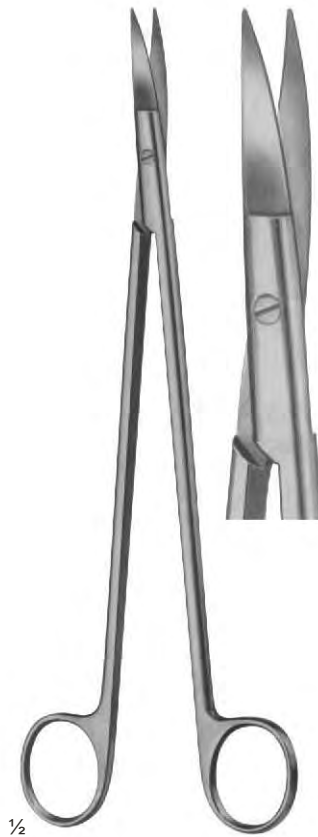

03-292
STRULLY
Pointed
Size: 220 mm



03-293
STRULLY
Probe Pointed
Size: 220 mm

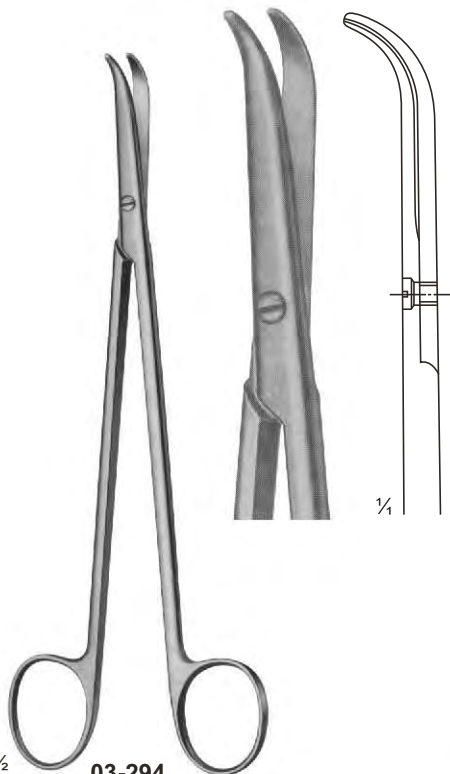
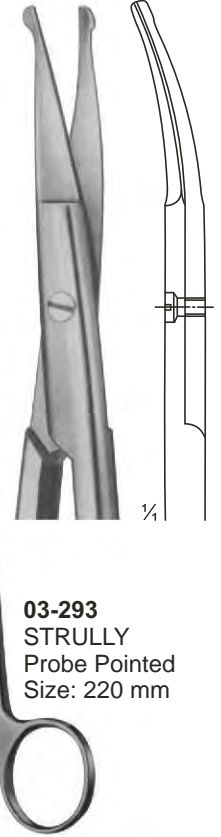

03-294
THOREK
Size: 190 mm

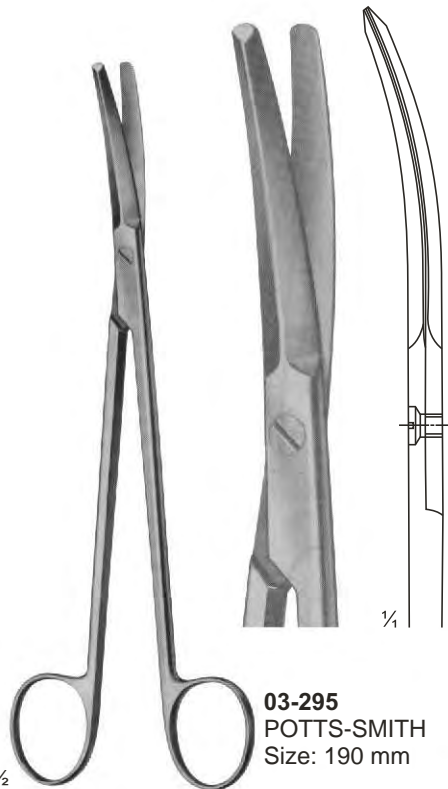

03-295
POTTS-SMITH
Size: 190 mm

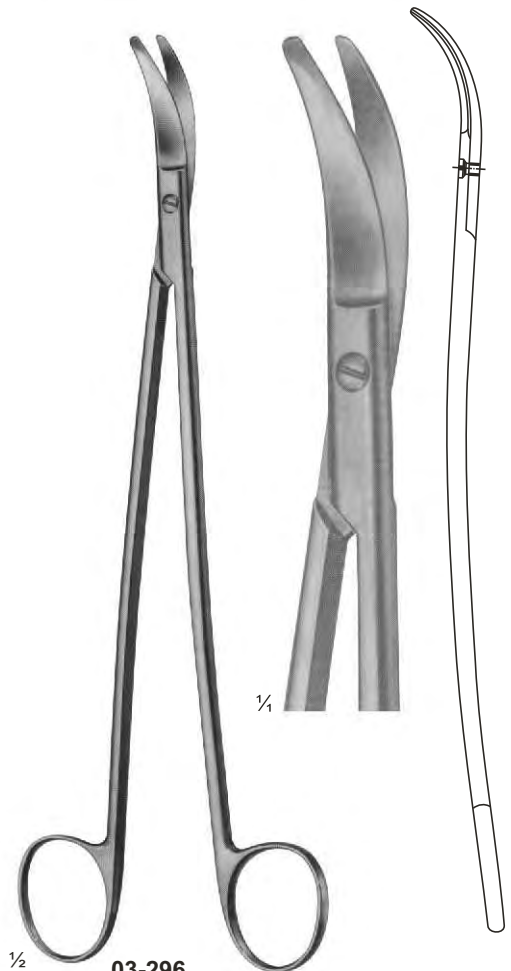

03-296
SATINSKY
Size: 245 mm

Delicate, Nasal and Tonsil Scissors

REALSTAR SURGICAL INSTRUMENTS



03-297
1 Finally Toothed Blade
Size: 130 mm

03-298
LOCKLIN
Curved Sideways,
1 Toothed Blade
Size: 155 mm

03-299
FOMON
Blades Serrated
Size: 145 mm

03-300
COTTLE
Size: 165 mm

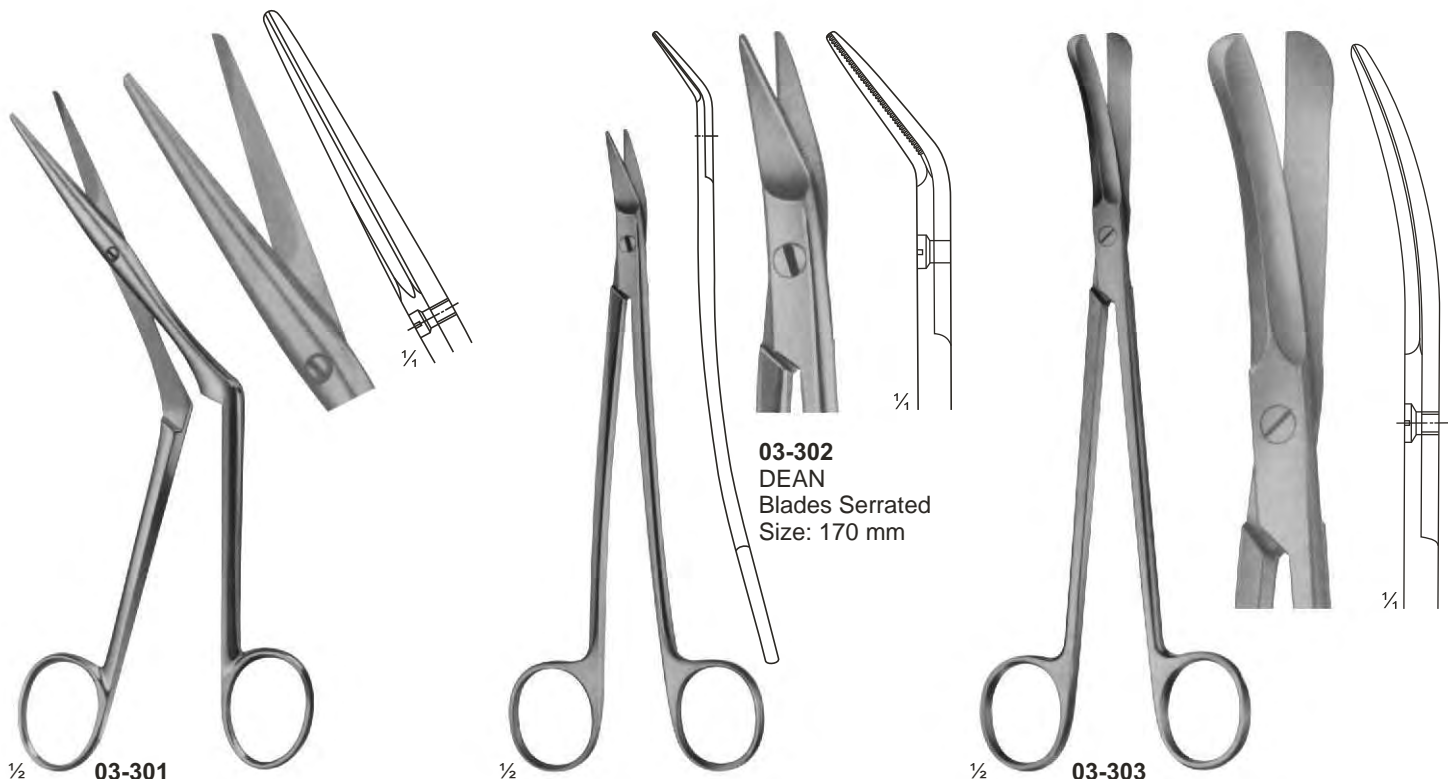

03-301
HEYMAN-KNIGHT

03-302
DEAN
Blades Serrated
Size: 170 mm

03-303
GOOD
Size: 195 mm

Bone Shears

REALSTAR SURGICAL INSTRUMENTS

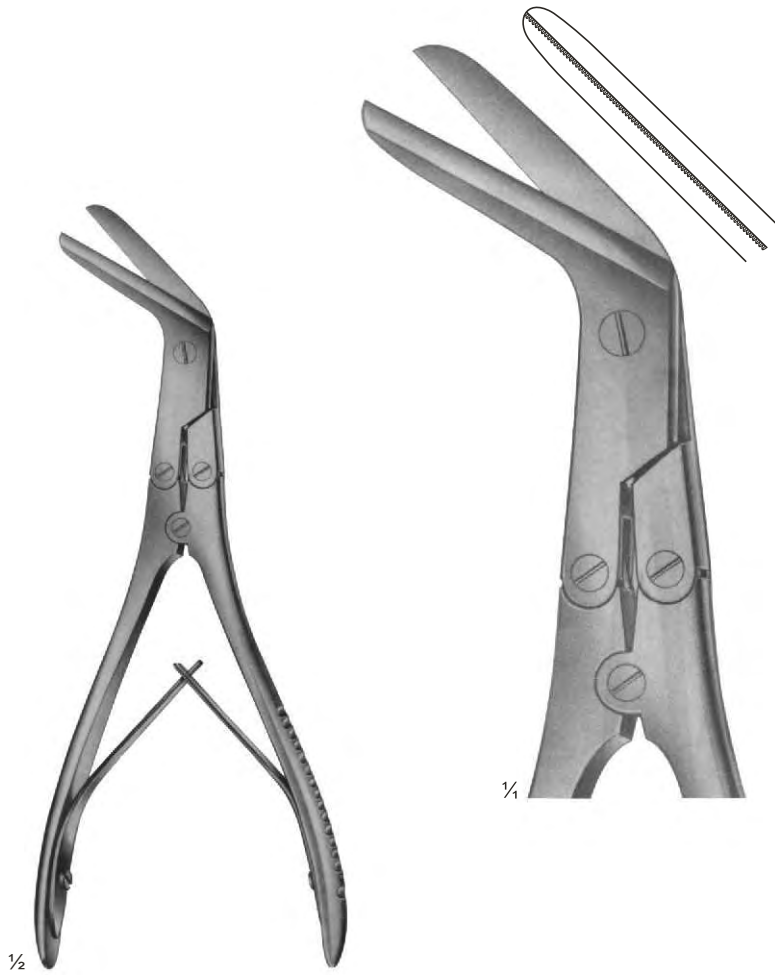

03-304
KILLIAN
Size: 200 mm

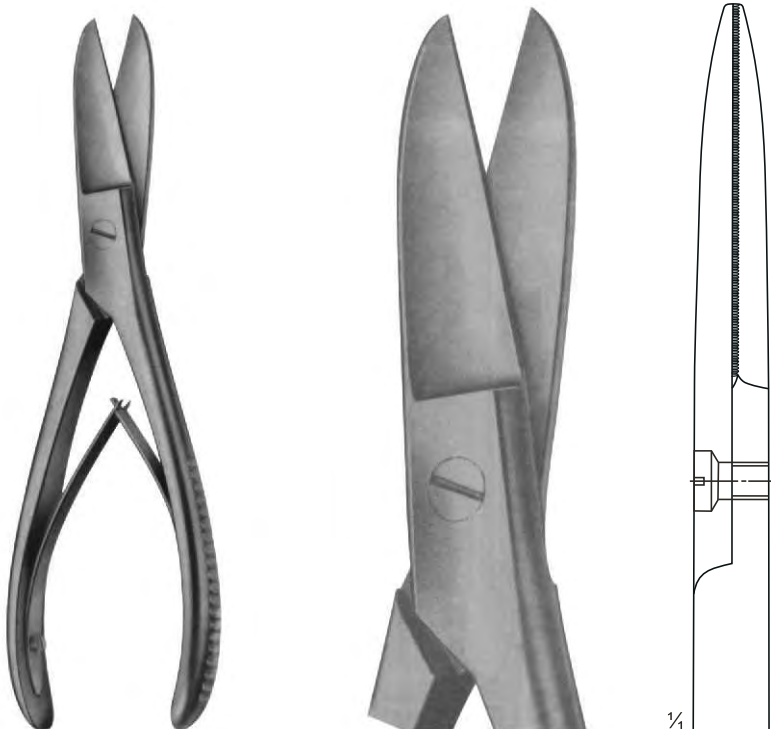

03-305 - 306

03-305
195 mm

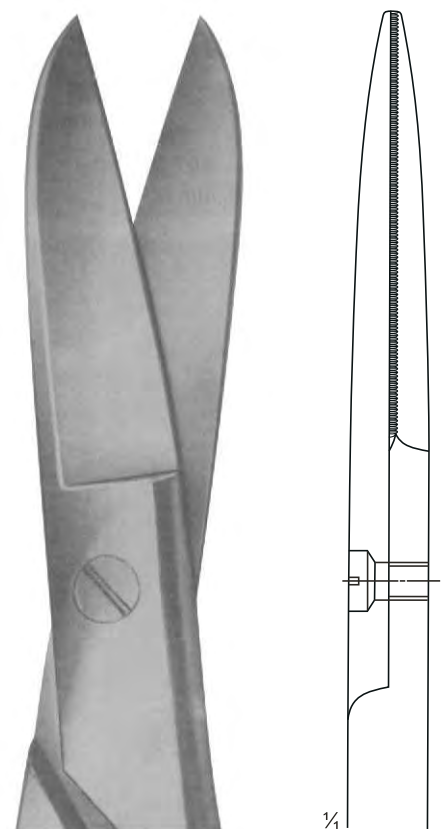

03-306
225 mm

Operating and Gynaecology Scissors

REALSTAR SURGICAL INSTRUMENTS

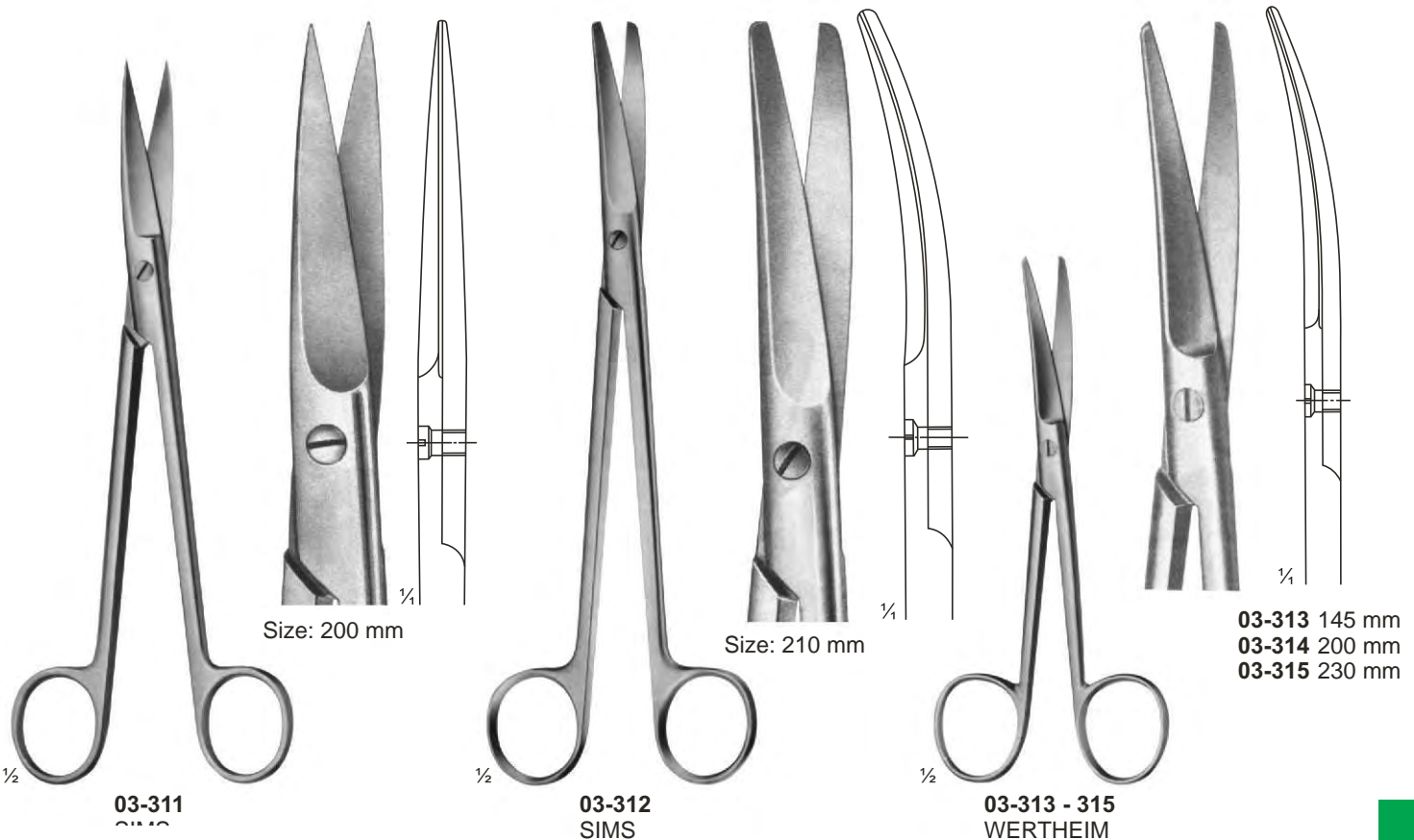
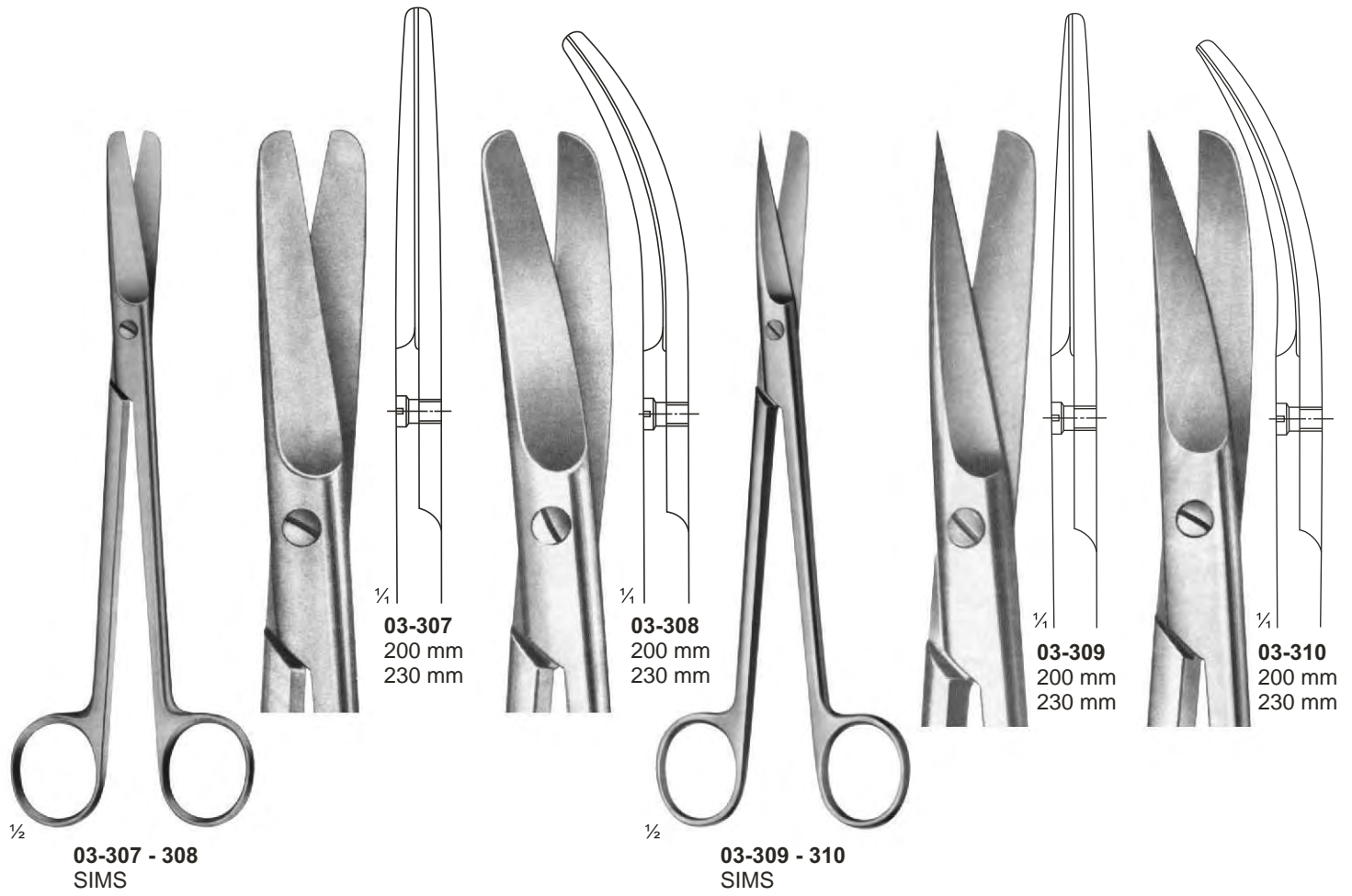

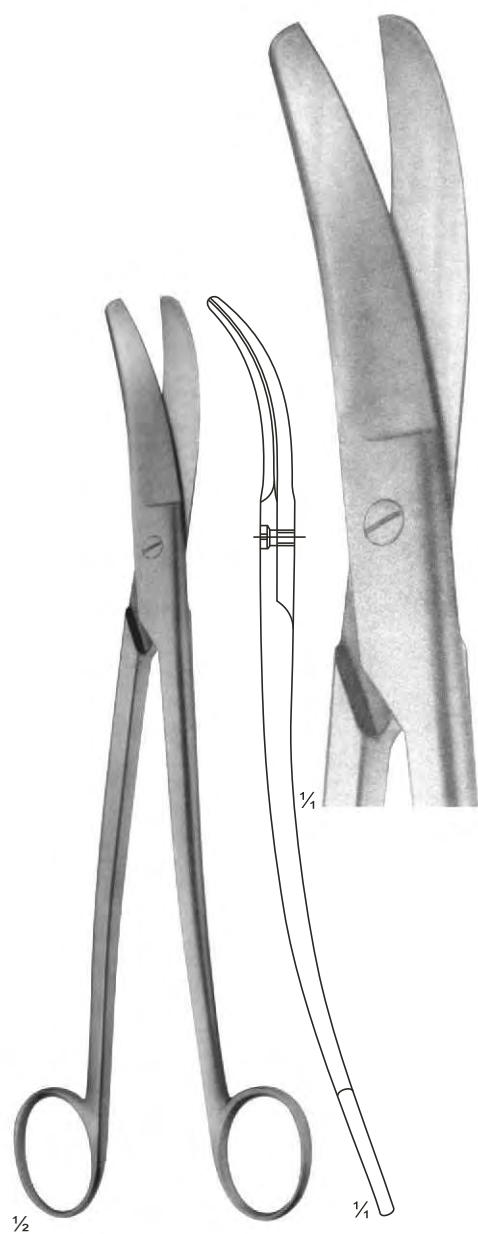

03-316
SIEBOLD
Uterine Scissors
Size: 245 mm

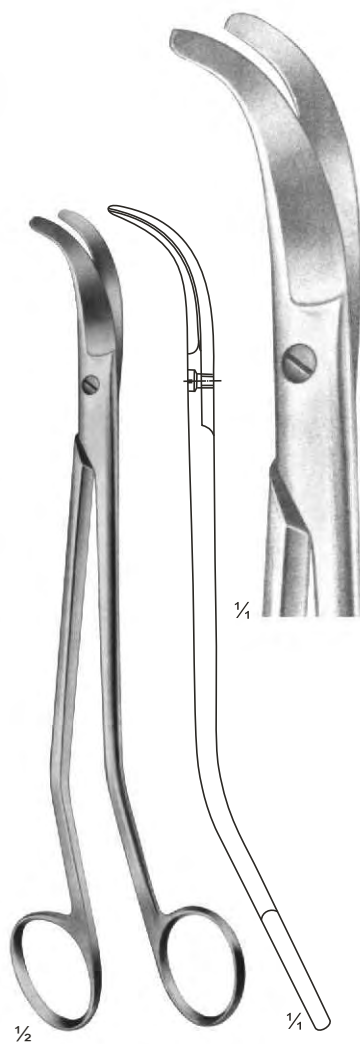

03-317
BOZEMANN
Uterine Scissors
Size: 220 mm

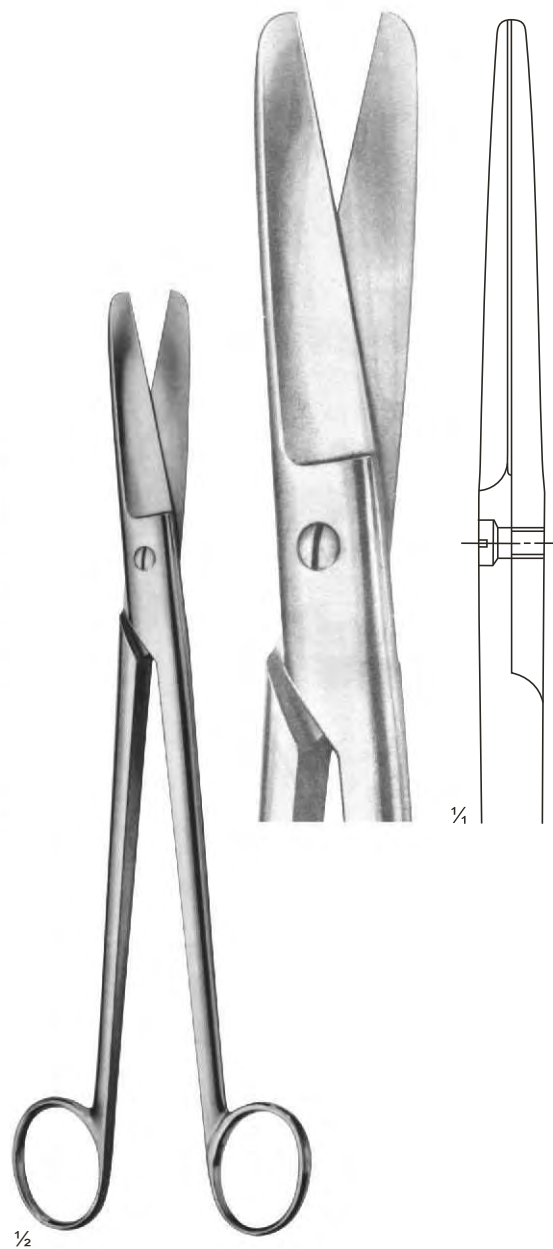

03-318
SIMS-SIEBOLD
Uterine Scissors
Size: 250 mm

Operating and Gynaecology Scissors

REALSTAR SURGICAL INSTRUMENTS



03-319
SCHUMACHER
Umbilical Cord Scissors
Size: 155 mm



03-320
Umbilical Cord Scissors
Size: 105 mm

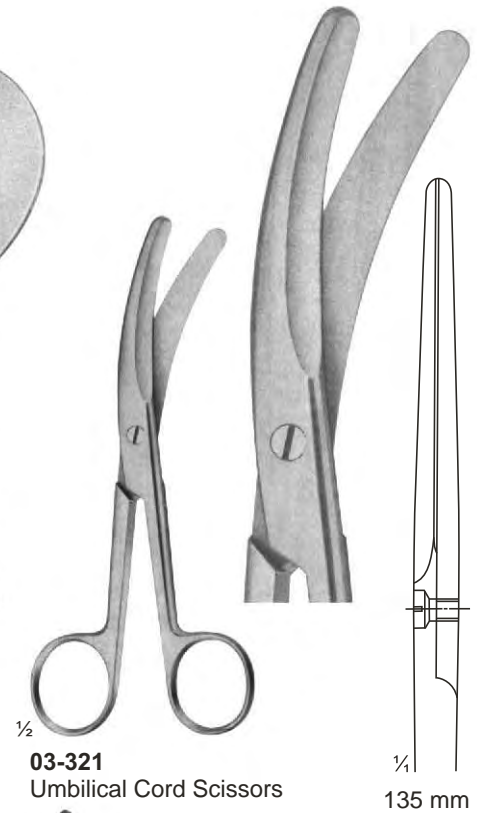

03-321
Umbilical Cord Scissors

135 mm

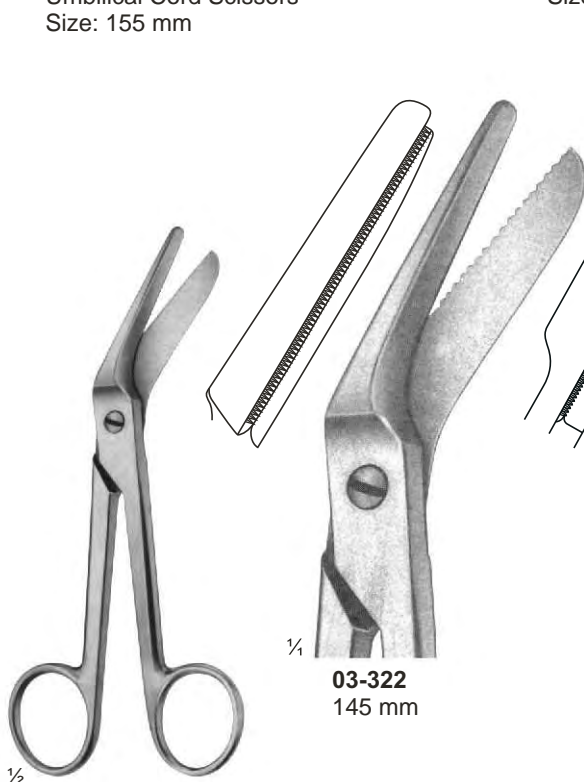

03-322 - 323
BRAUN-STADLER
Empisiotomy Scissors

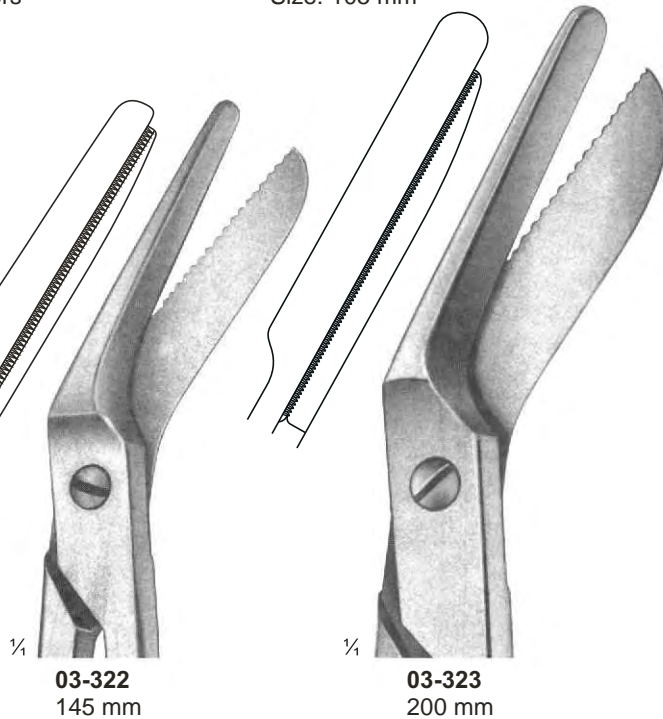

03-322
145 mm

03-323
200 mm

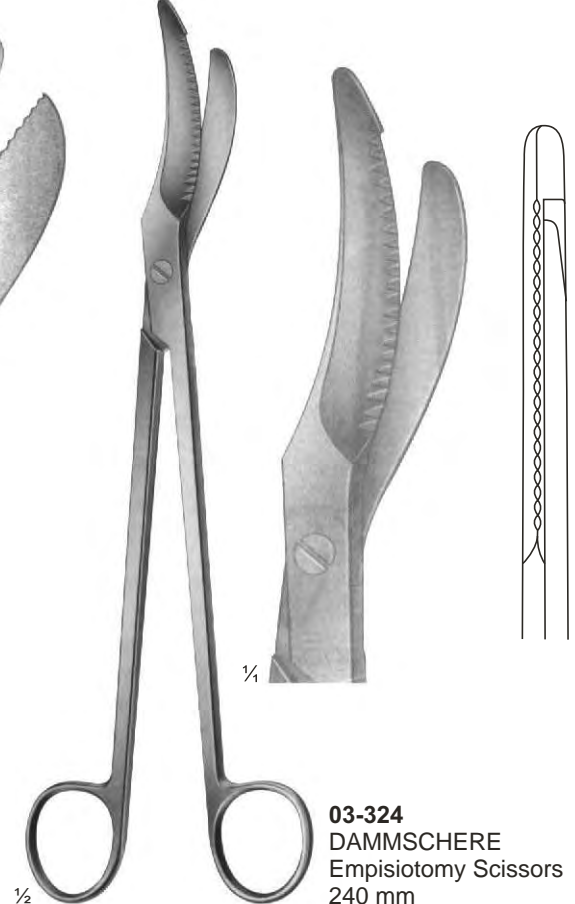

03-324
DAMMSCHERE
Empisiotomy Scissors
240 mm

Bowel Scissors, Cartilage Scissors

REALSTAR SURGICAL INSTRUMENTS

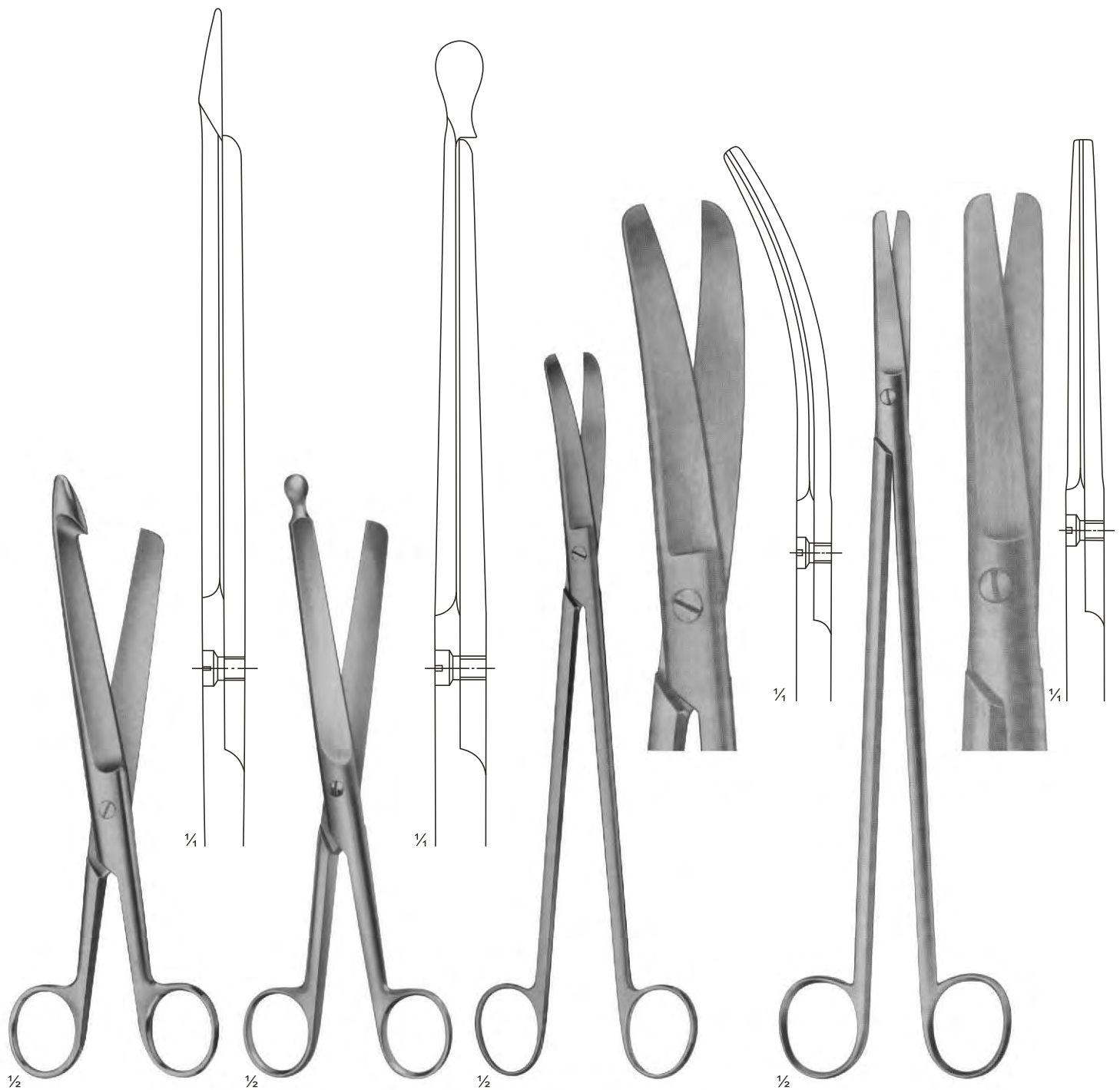

03-325
DAMMSCHERE
Bowel Scissors
Size: 210 mm

03-326
DAMMSCHERE
Bowel Scissors
Size: 210 mm

03-327
LLOYD-DAVIES
(GOLIGHER'S)
Rectal Scissors
Size: 255 mm

03-328
STELZNER
Rectal Scissors
Size: 310 mm

Ligature Scissors

REALSTAR SURGICAL INSTRUMENTS

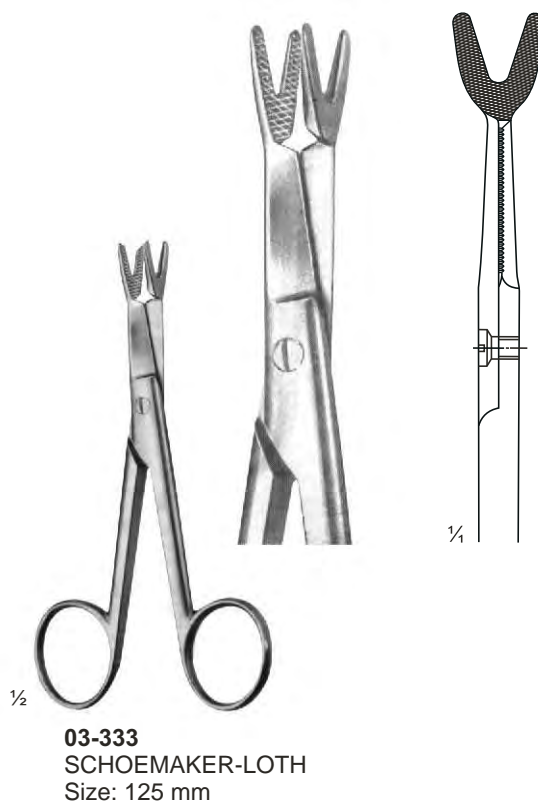
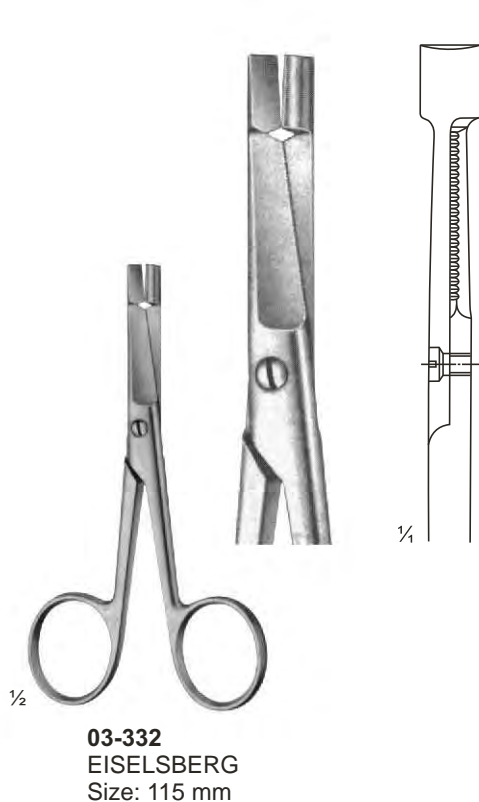
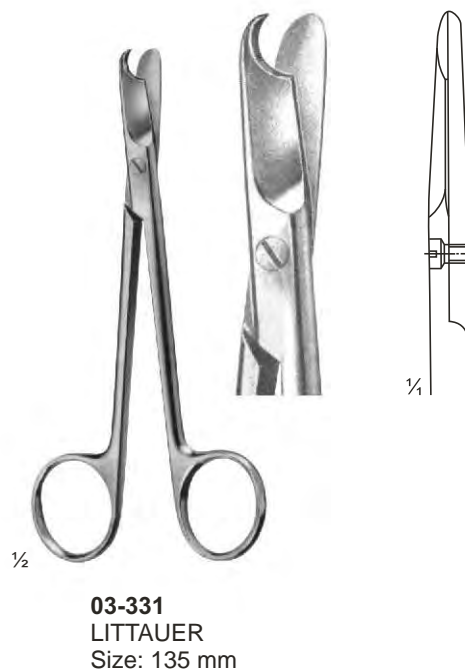

Wire and Plate Scissors

REALSTAR SURGICAL INSTRUMENTS

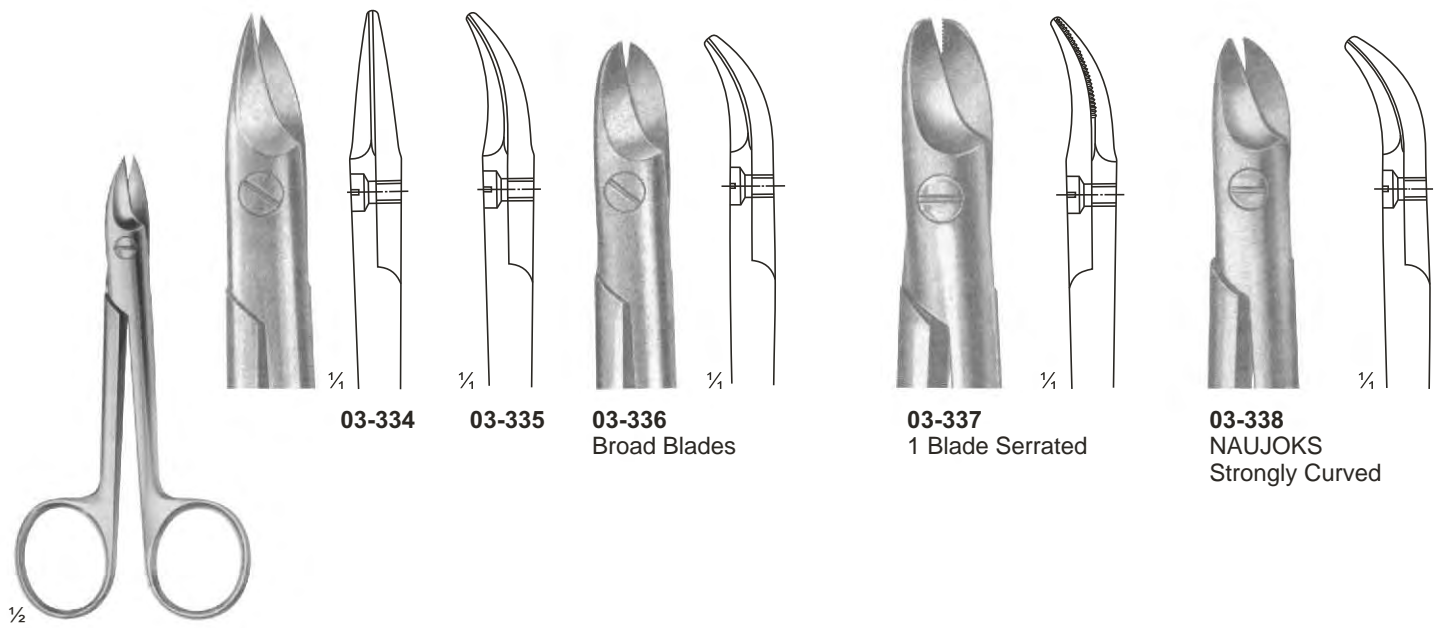

03-334 - 338
BEEBE
Size: 110 mm

03-334

03-335

03-336
Broad Blades

03-337
1 Blade Serrated

03-338
NAUJOKS
Strongly Curved

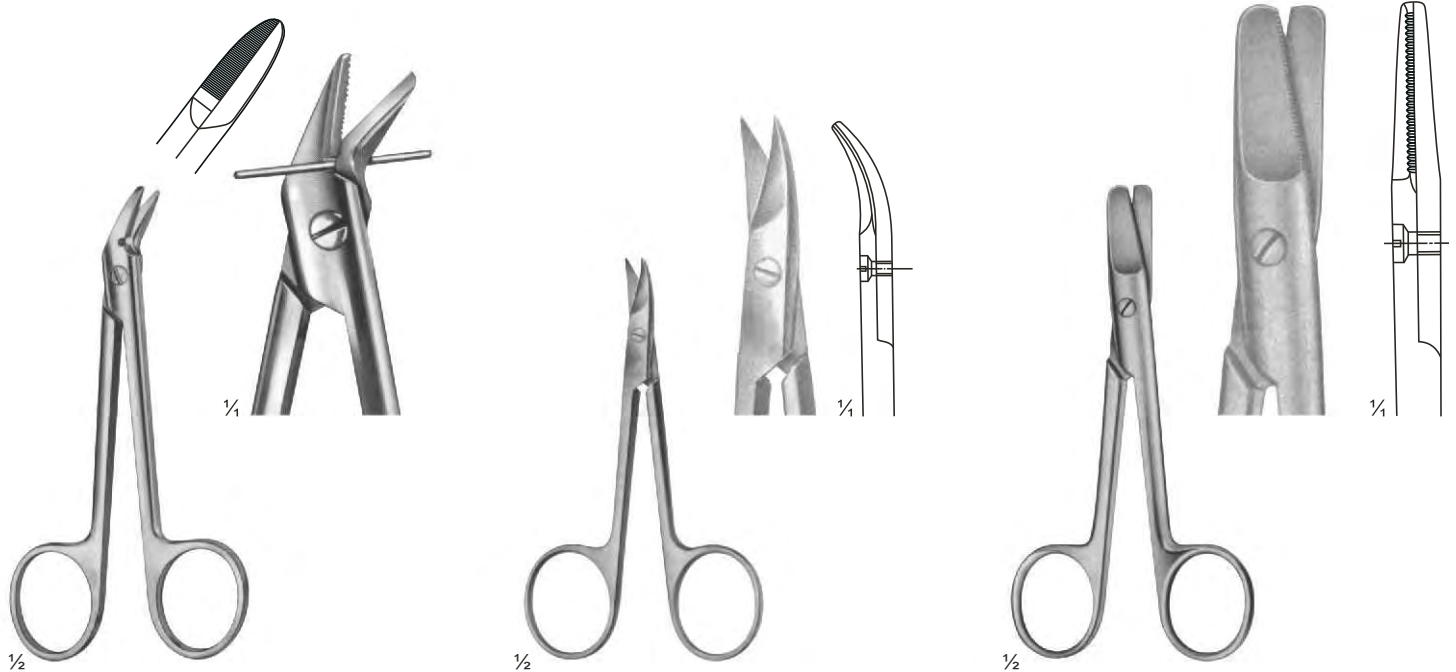

03-339
1 Blade Serrated
Size: 120 mm

03-340
STRACK
Size: 100 mm

03-341
HARVEY
Size: 125 mm

Wire and Plate Scissors

REALSTAR SURGICAL INSTRUMENTS

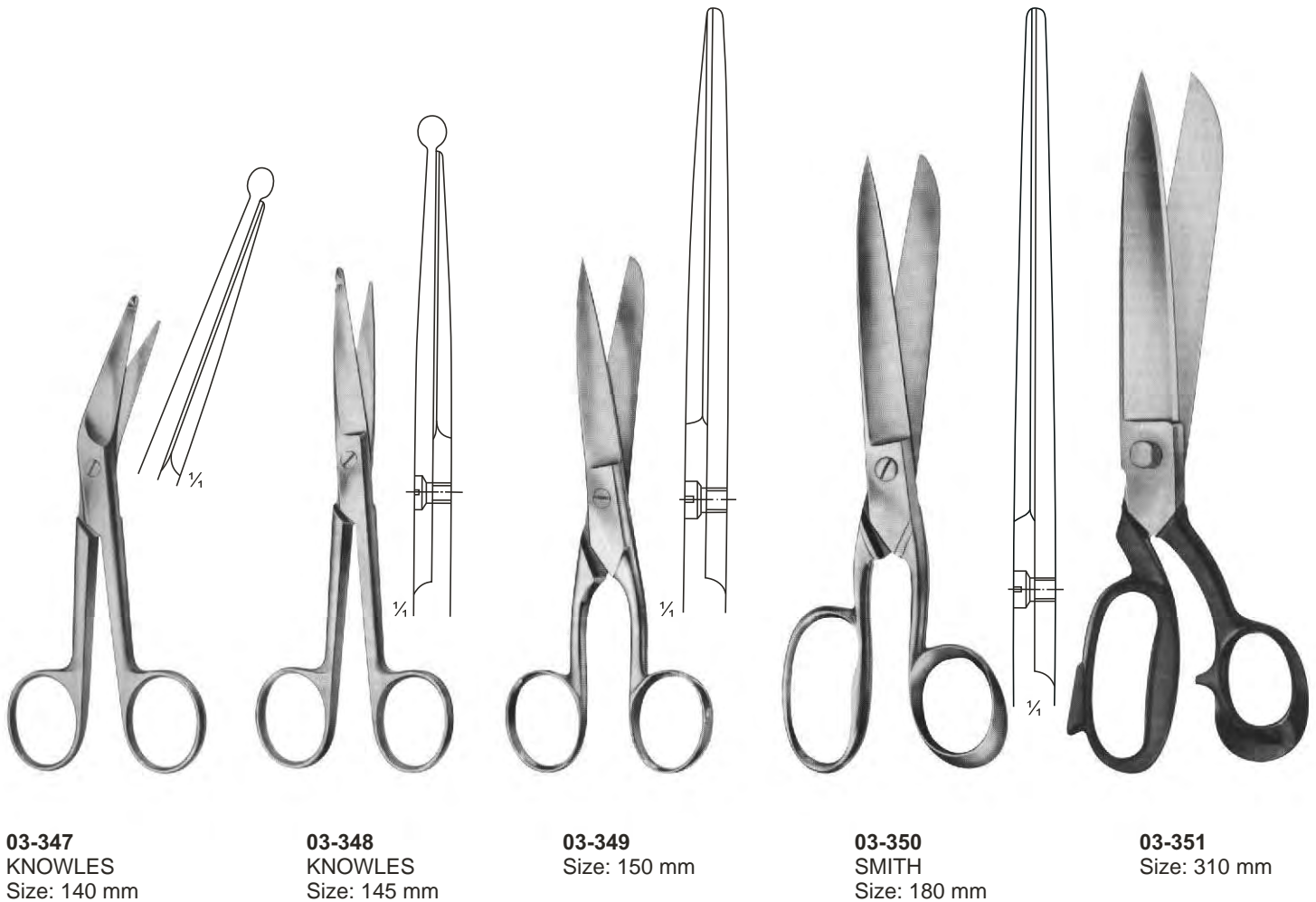
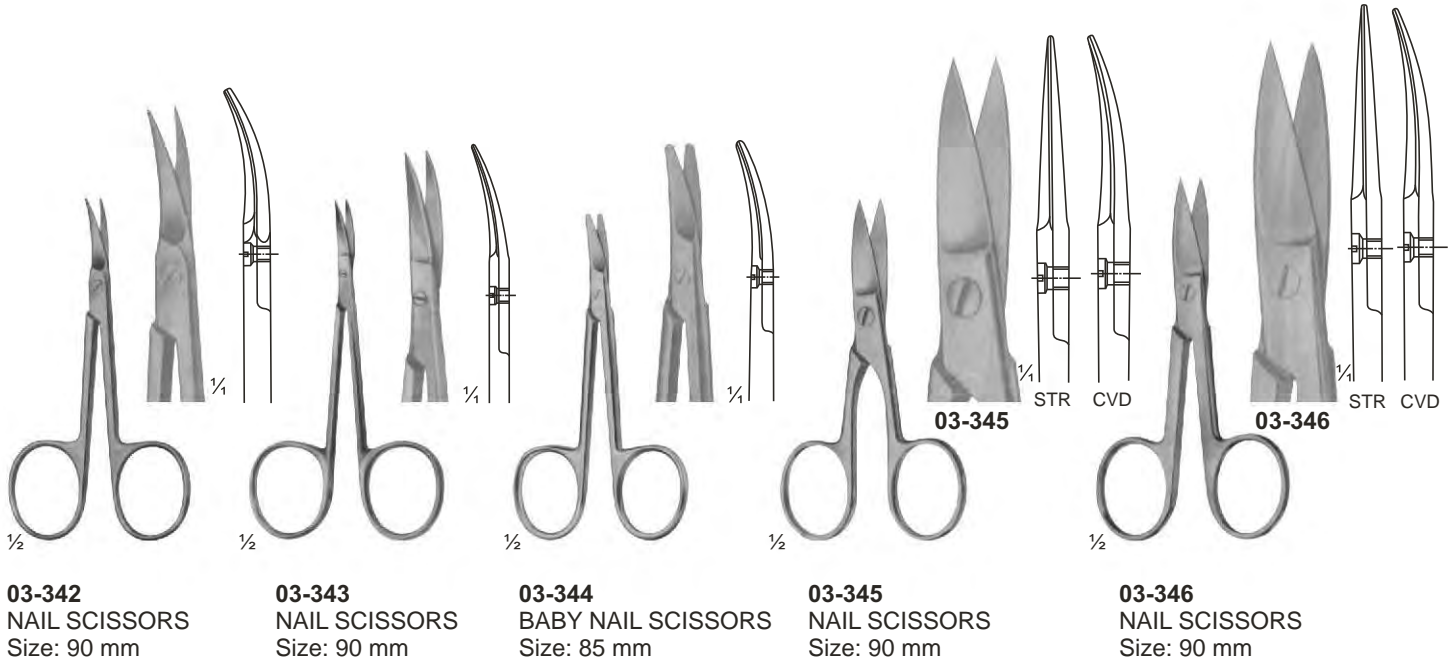

Bandage and Cloth Scissors

REALSTAR SURGICAL INSTRUMENTS



03-352
UNIVERSAL AND BANDAGE SCISSORS
180 mm

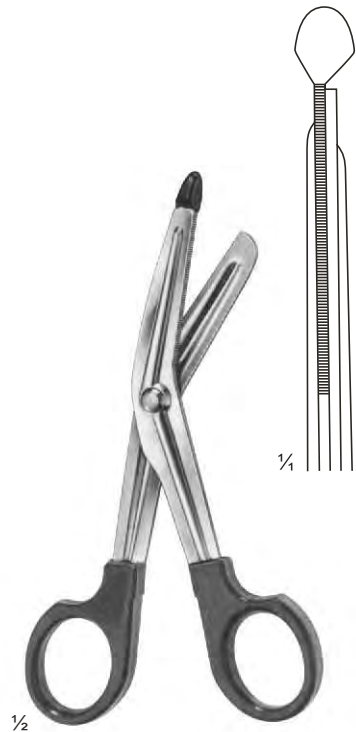

03-353
LISTER
Size: 145 mm

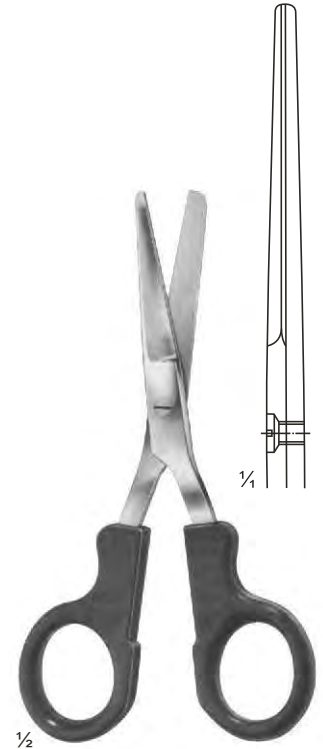

03-354
LISTER
Size: 145 mm

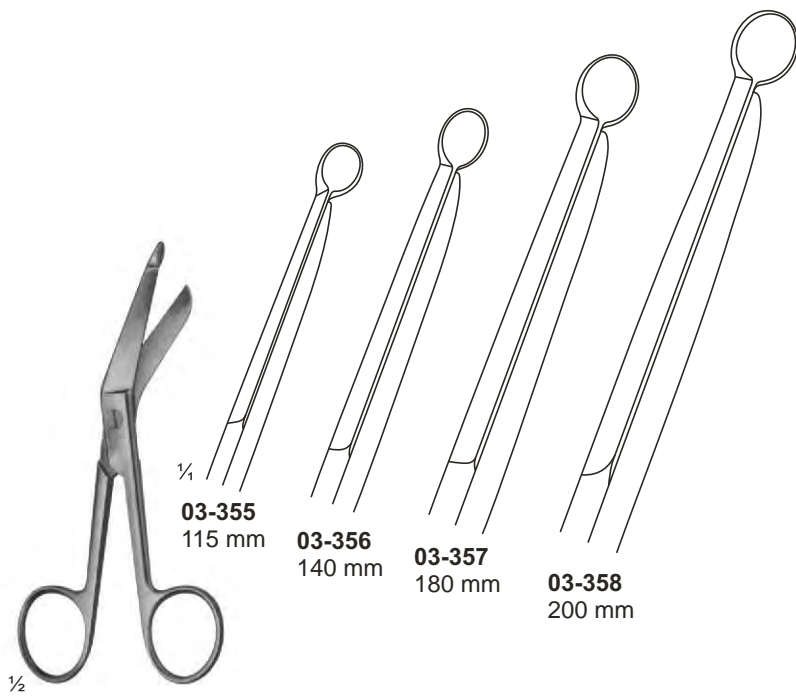

03-355 - 358
LISTER

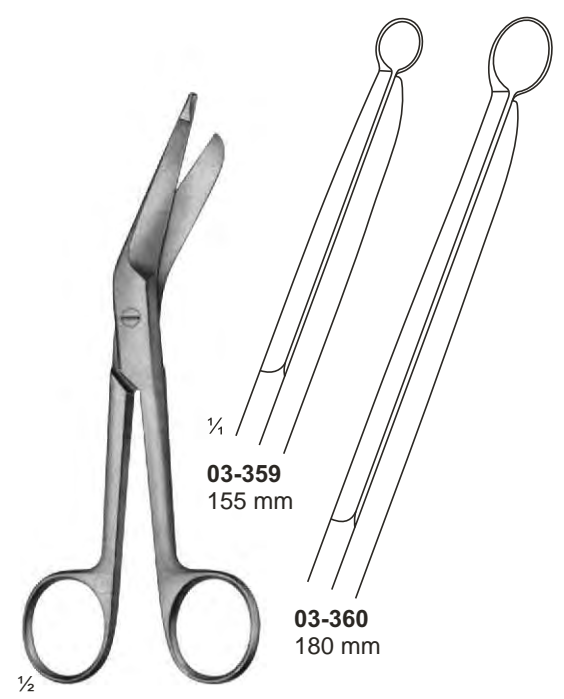

03-359 - 360
LISTER

Bandage, Cloth and Plaster Scissors

REALSTAR SURGICAL INSTRUMENTS

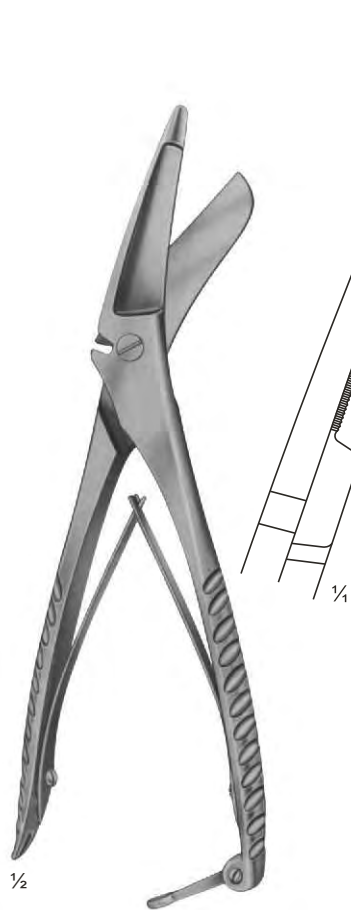

03-361
CLOTH SCISSORS
205 mm

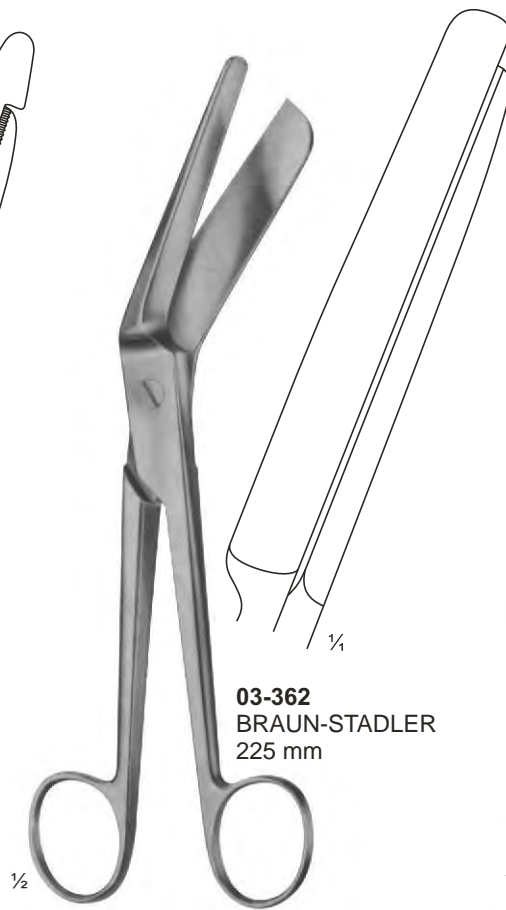

03-362
BRAUN-STADLER
225 mm

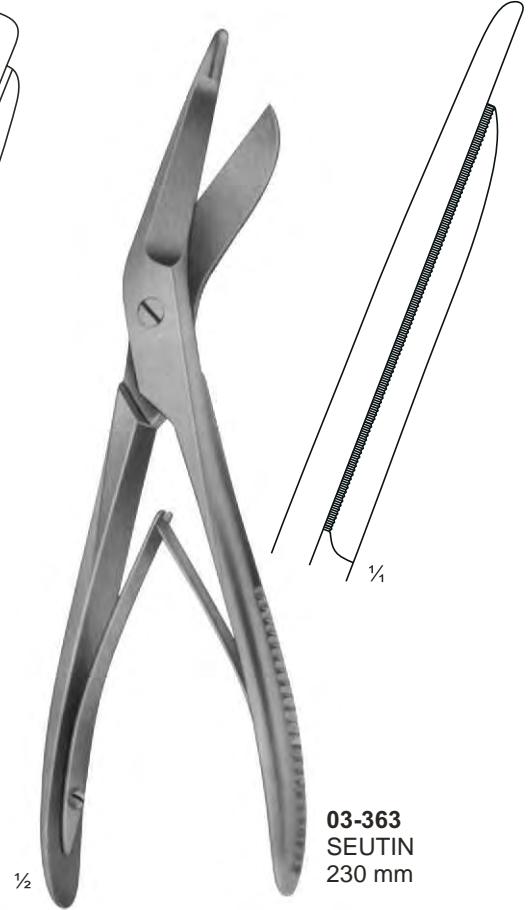

03-363
SEUTIN
230 mm

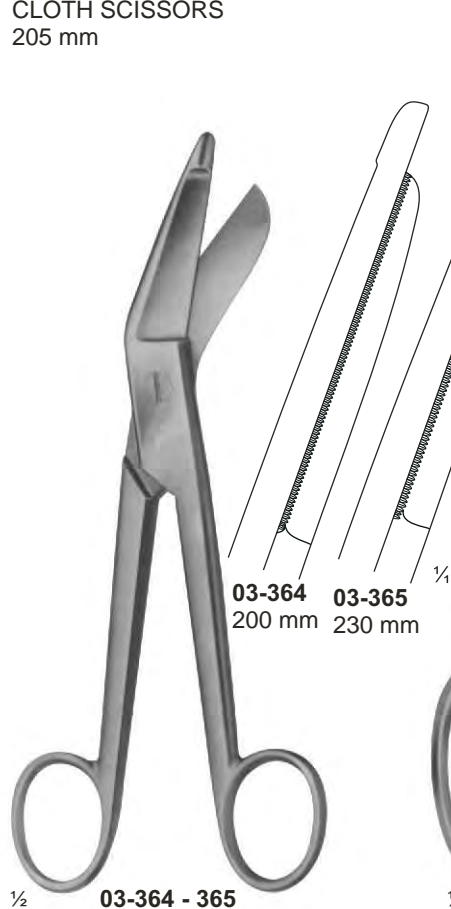

03-364
200 mm

03-365
230 mm

03-364 - 365
ESMARCH

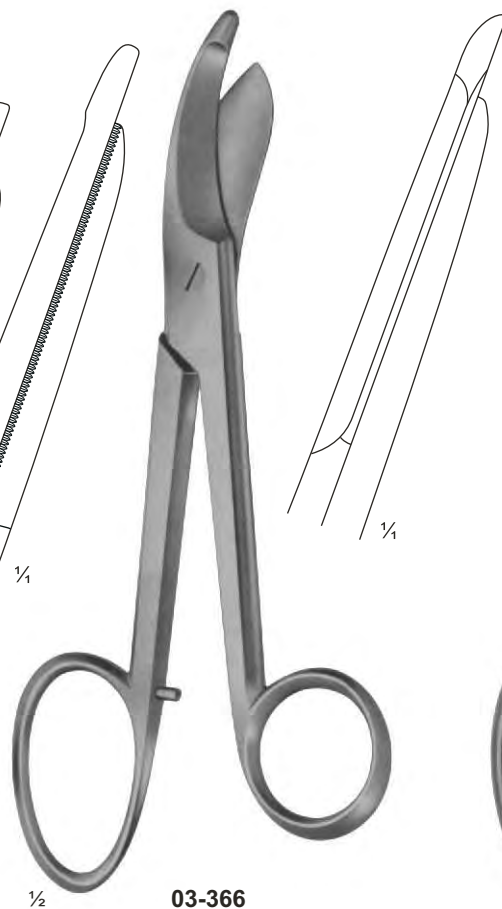

03-366
BRUNS
235 mm

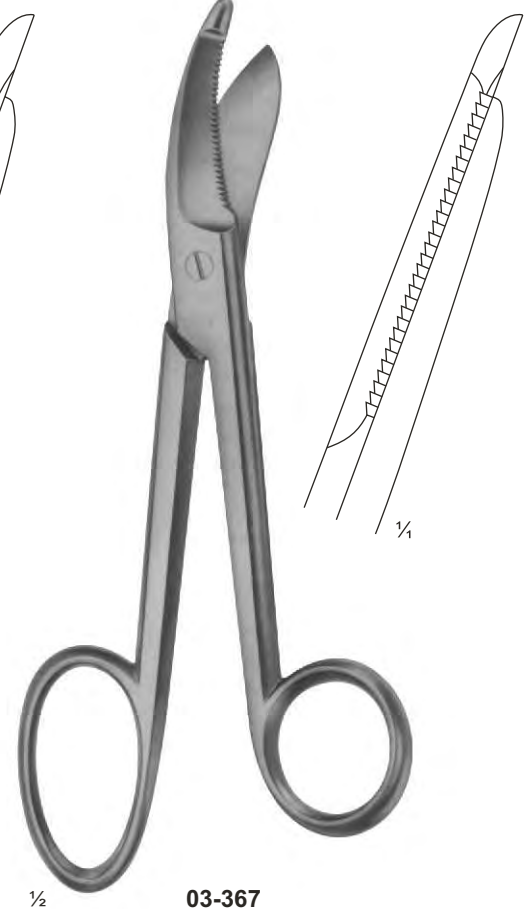

03-367
BRUNS
235 mm

Micro Forceps, Jeweler Types

REALSTAR SURGICAL INSTRUMENTS

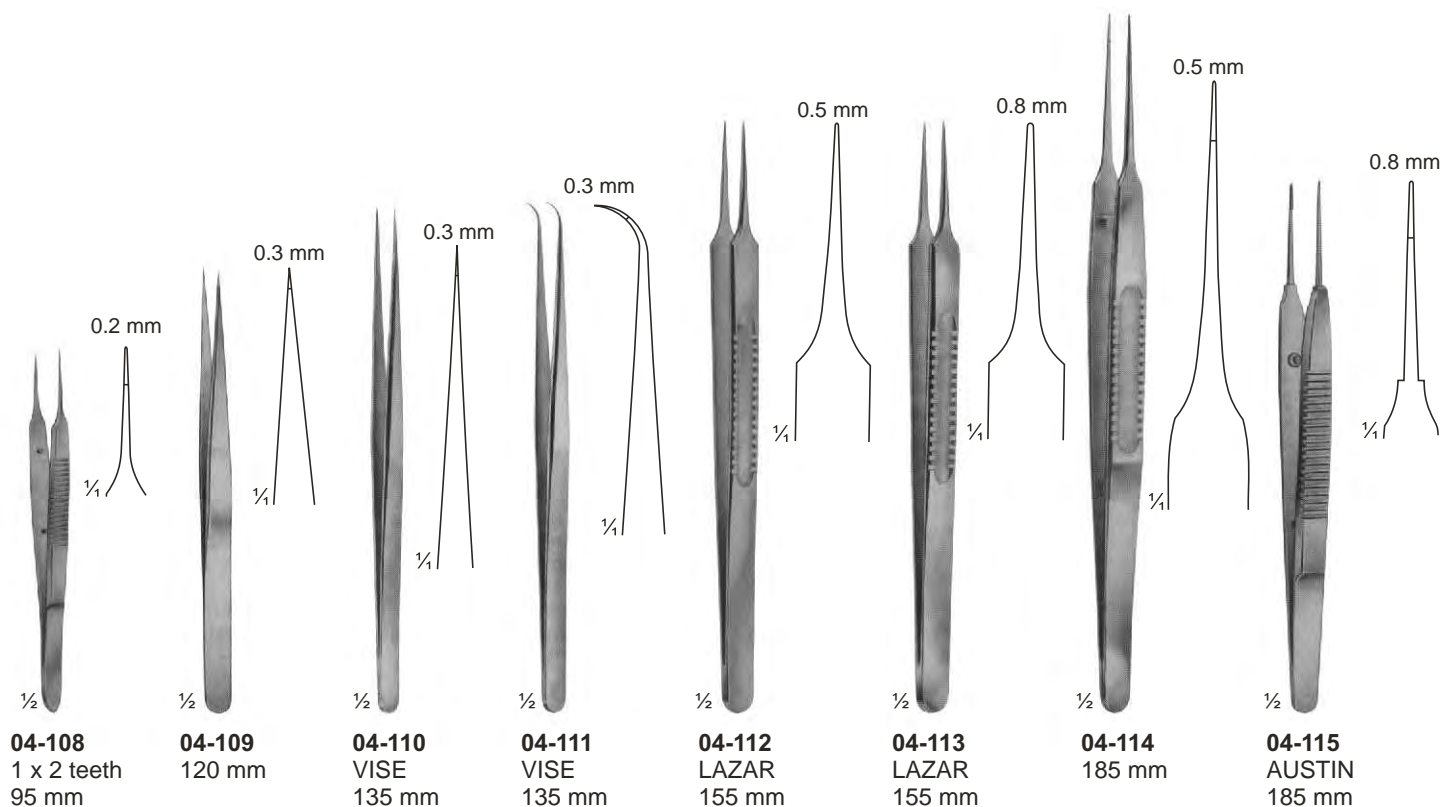
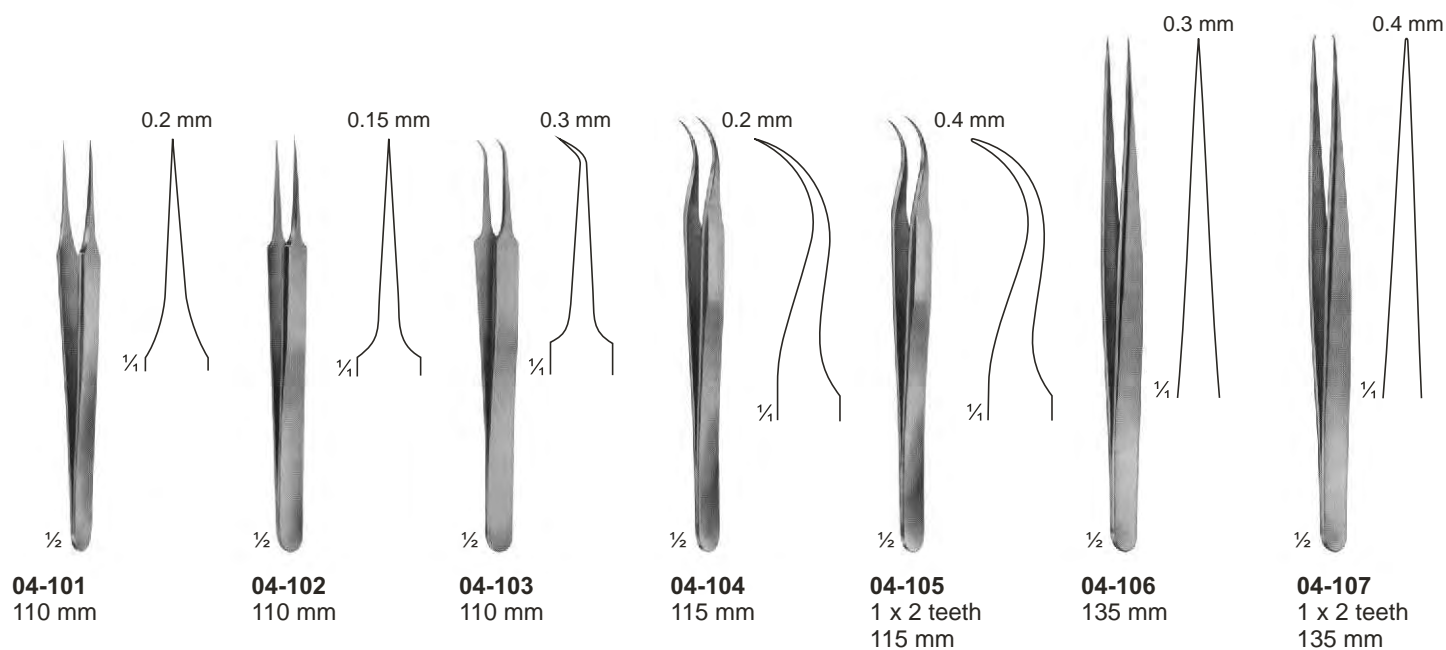

Ligature Forceps, Micro Forceps (Light Patterns)

REALSTAR SURGICAL INSTRUMENTS

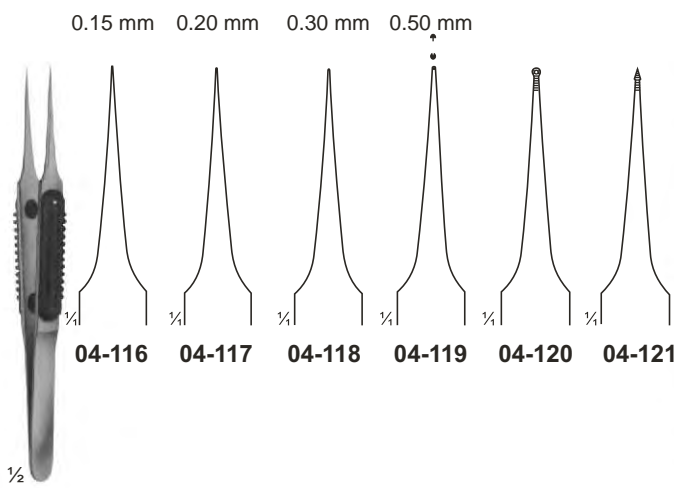

04-116 - 121
MULLER
110 mm

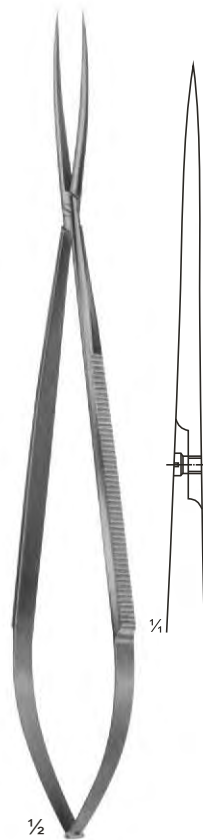

04-122
LIGATURE FORCEPS
220 mm



04-123
YASARGIL
185 mm

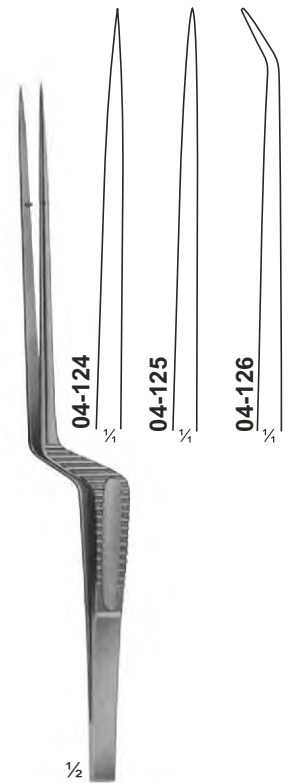

04-124 - 126
MICRO FORCEPS
185 mm

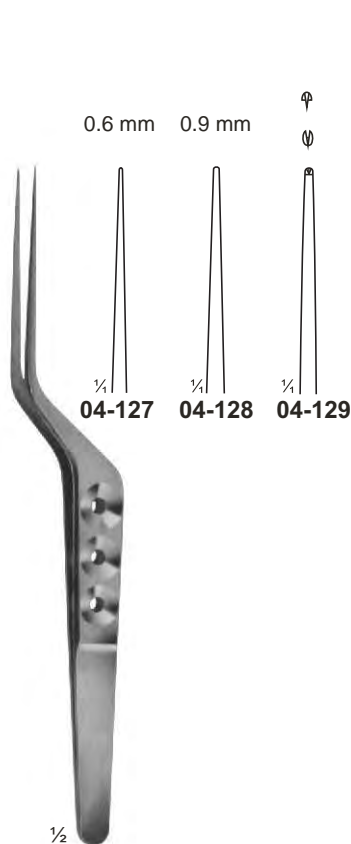

04-127 - 129
YASARGIL
180 mm

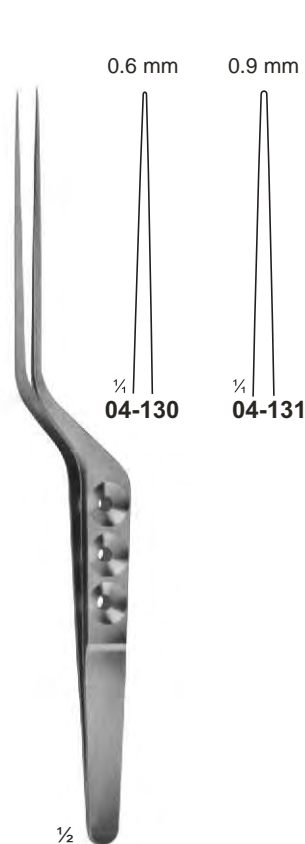

04-130 - 131
YASARGIL
200 mm



04-132 - 133
YASARGIL
220 mm

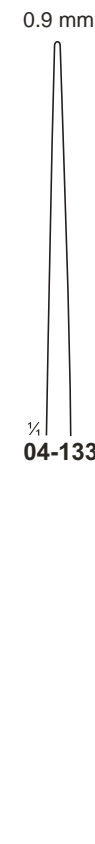

04-133



04-134 - 135
YASARGIL
240 mm

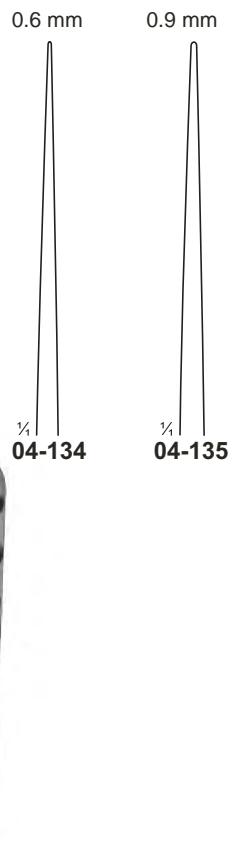

04-135

REALSTAR SURGICAL INSTRUMENTS

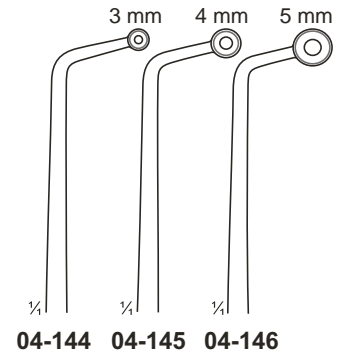
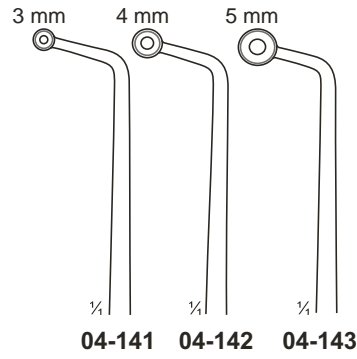
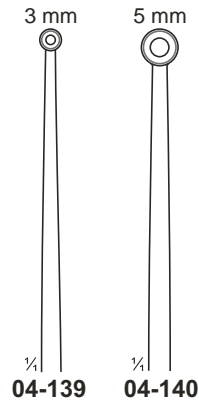
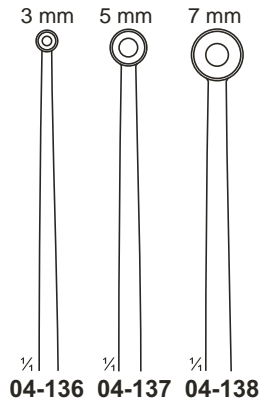

04-136 - 138
YASARGIL-SAMI
Jaws Spoon-Shaped
240 mm

04-139 - 140
YASARGIL
Jaws Spoon-Shaped
220 mm

04-141 - 143
SAMII
Jaws Spoon-Shaped
230 mm

04-144 - 146
SAMII
Jaws Spoon-Shaped
230 mm

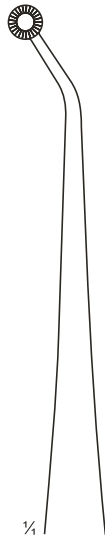

04-147 1/2
HUNT
Tumor-and Vessel Forceps
200 mm

04-148 1/2
HUNT
Tumor-and Vessel Forceps
200 mm

04-149 1/2
YASARGIL
Tumor-and Vessel Forceps
200 mm

Delicate Dissecting, Microscopic, Sterilizing Forceps

REALSTAR SURGICAL INSTRUMENTS

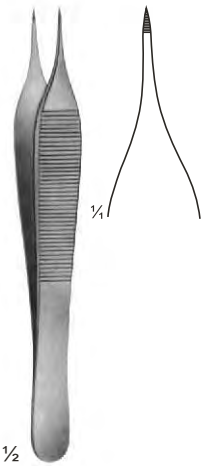

04-150
THORPE
Corneal Forceps
120 mm

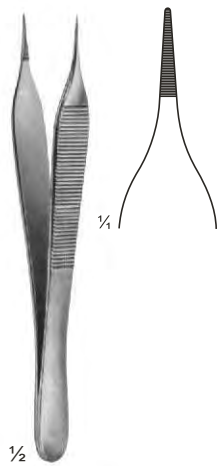

04-151
MICRO-ADSON
120 mm

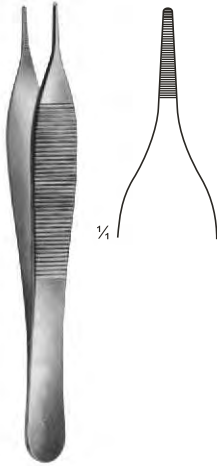

04-152
ADSON
120 mm

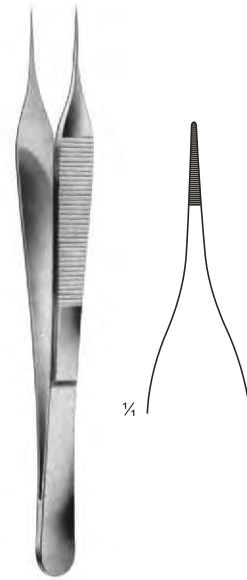

04-153
MICRO-ADSON
150 mm



04-154 - 156
100 mm



04-154



04-155



04-156

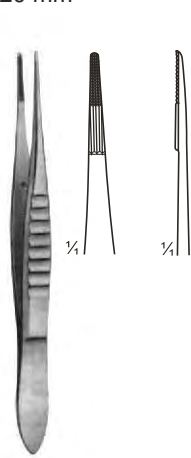

04-157
110 mm

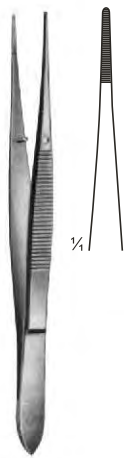

04-158
115 mm



04-159 - 168

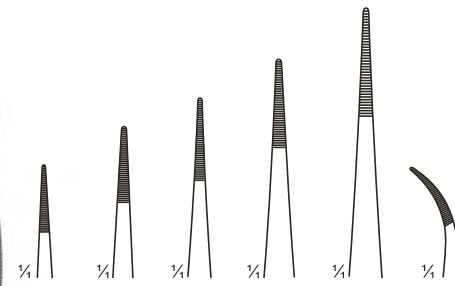

04-159 90 mm **04-160** 105 mm **04-161** 115 mm **04-162** 130 mm **04-163** 145 mm **04-164** 90 mm

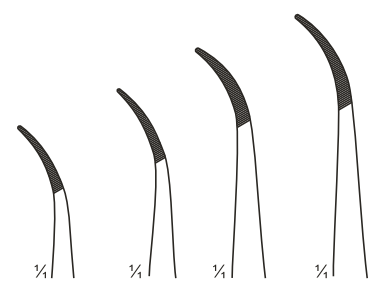

04-165 105 mm **04-166** 115 mm **04-167** 130 mm **04-168** 145 mm

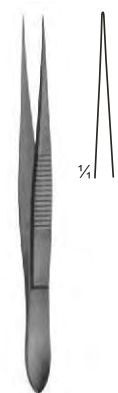

04-169
100 mm

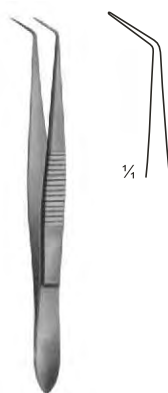

04-170
100 mm



04-171
100 mm

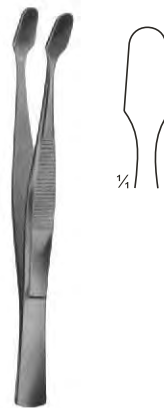

04-172
COVER GLASS FORCEPS
105 mm



04-173
160 mm

Delicate Dissecting Forceps

REALSTAR SURGICAL INSTRUMENTS

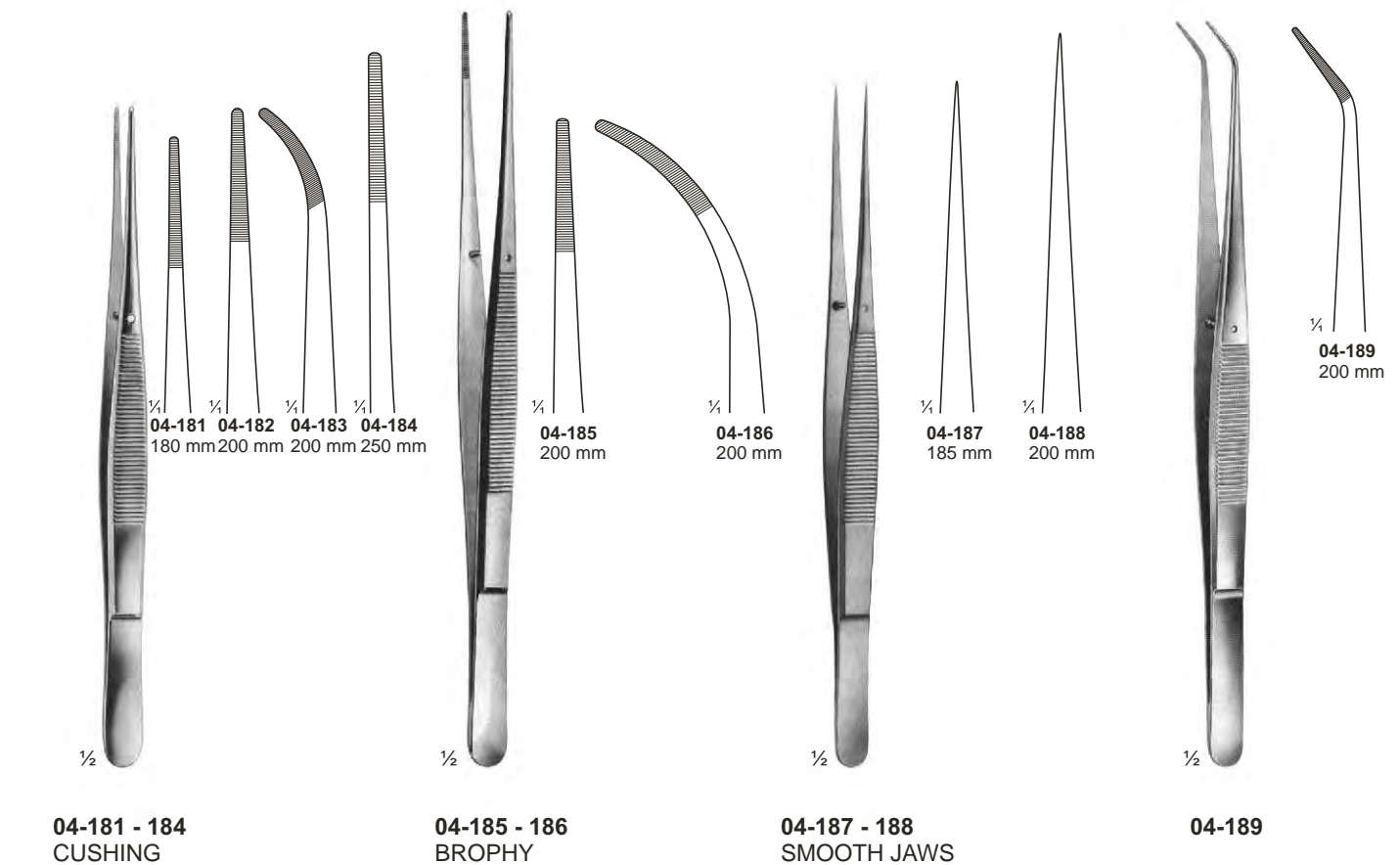
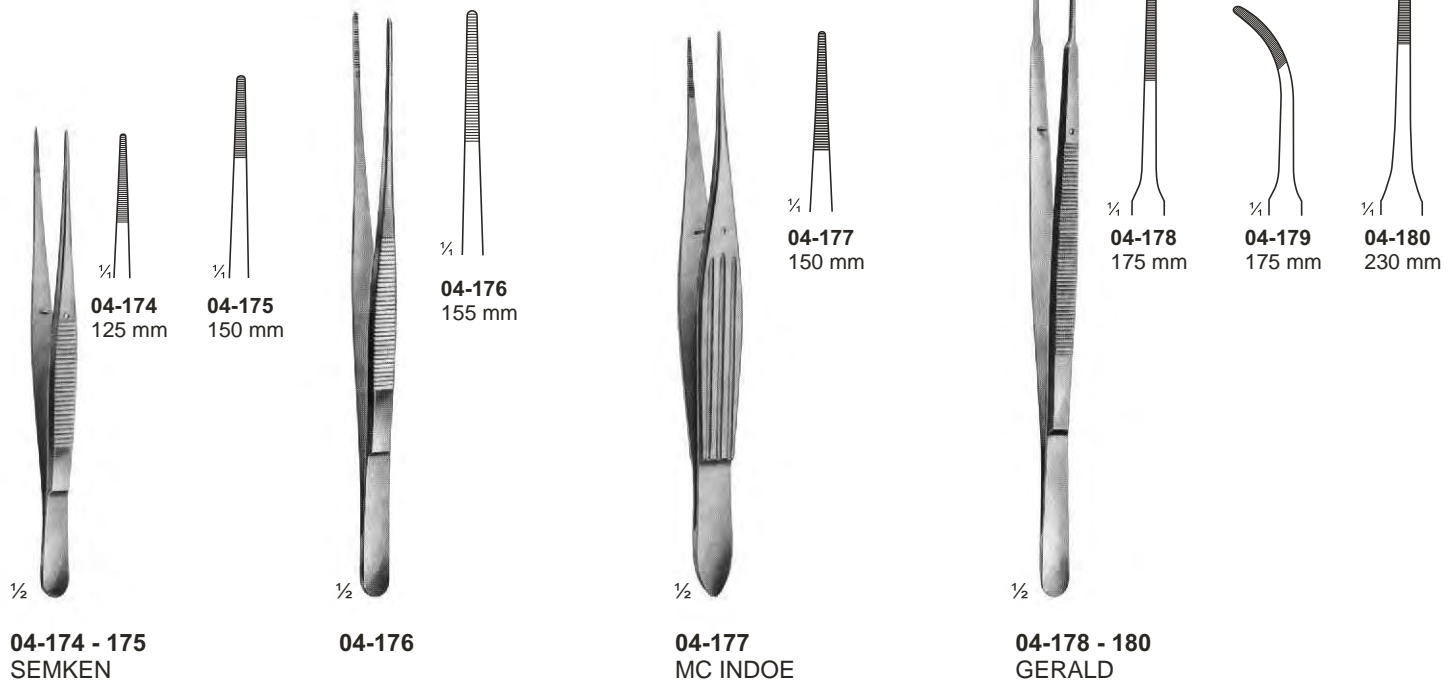

Dissecting Forceps

REALSTAR SURGICAL INSTRUMENTS



1/2

04-190 - 197
STANDARD

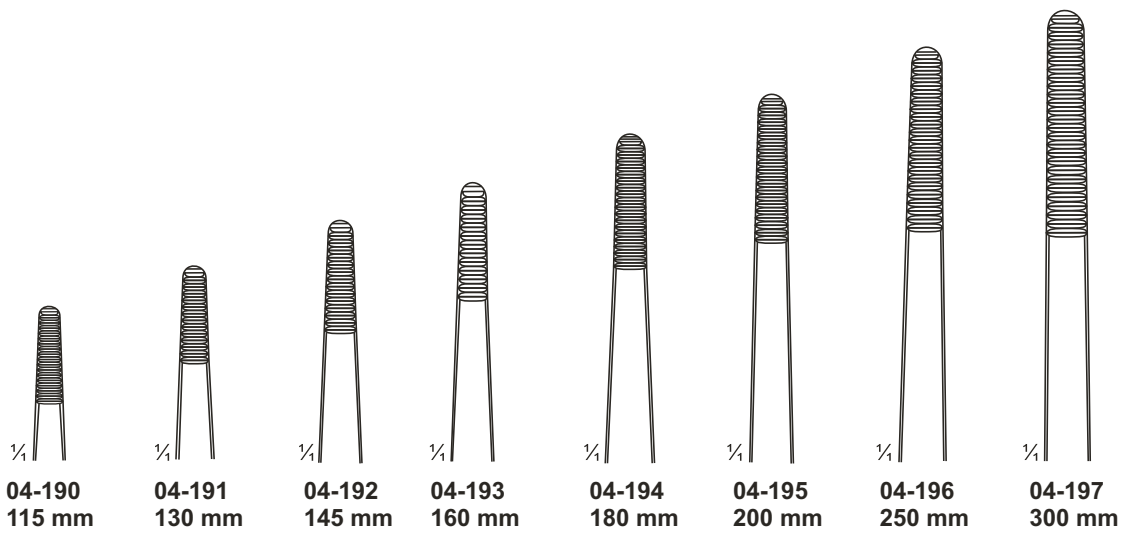

04-190
115 mm

04-191
130 mm

04-192
145 mm

04-193
160 mm

04-194
180 mm

04-195
200 mm

04-196
250 mm

04-197
300 mm



1/2

04-198 - 202
MEDIUM

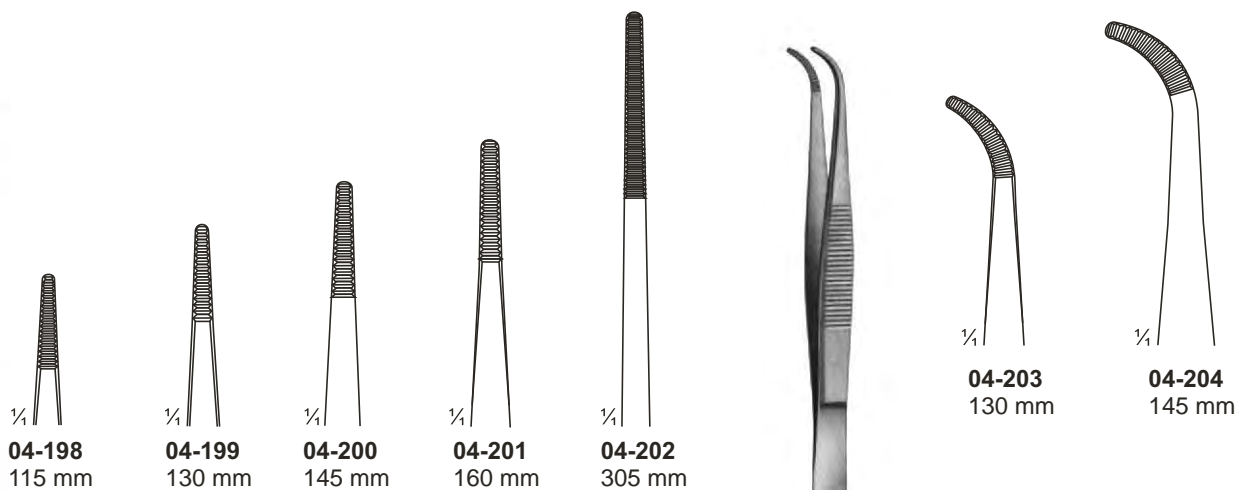

04-198
115 mm

04-199
130 mm

04-200
145 mm

04-201
160 mm

04-202
305 mm

04-203
130 mm

04-204
145 mm

1/2

04-203 - 204
MEDIUM

Dissecting Forceps

REALSTAR SURGICAL INSTRUMENTS



04-205
125 mm



04-206
155 mm

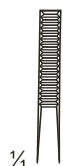

04-207
130 mm

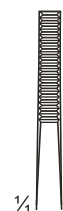

04-208
150 mm

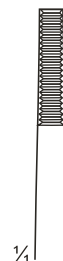

04-209
170 mm

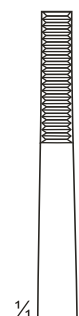

04-210
200 mm

04-205 - 206

04-207 - 210



04-211
OCHSNER

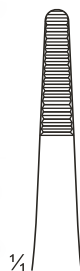

04-212
FRICKE



04-213
BONNEY

Ultra-Light Forceps

REALSTAR SURGICAL INSTRUMENTS

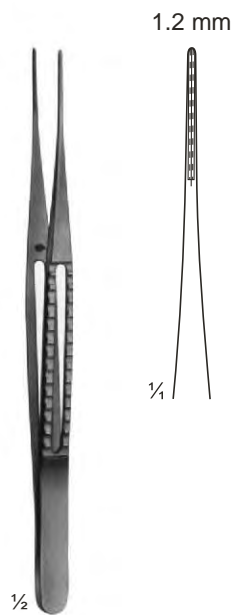

04-214
150 mm

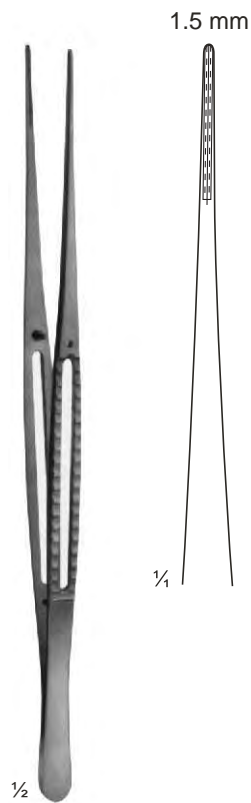

04-215
200 mm

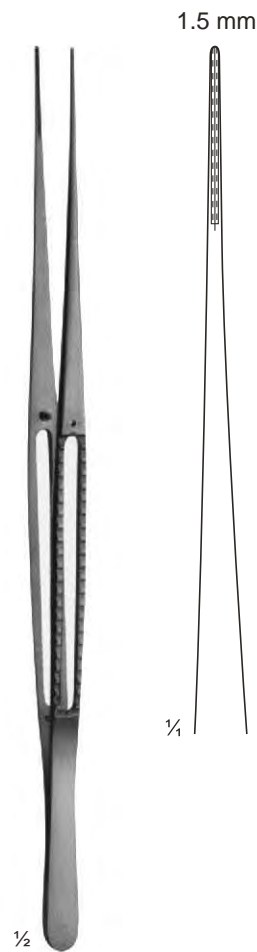

04-216
240 mm

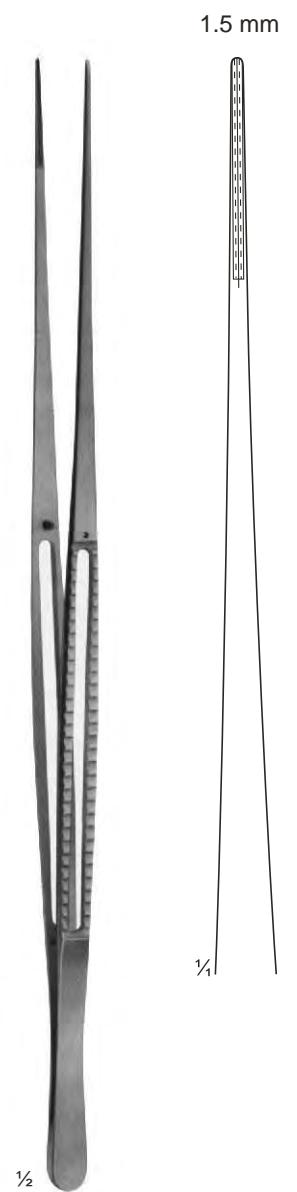

04-217
300 mm

Forceps

REALSTAR SURGICAL INSTRUMENTS

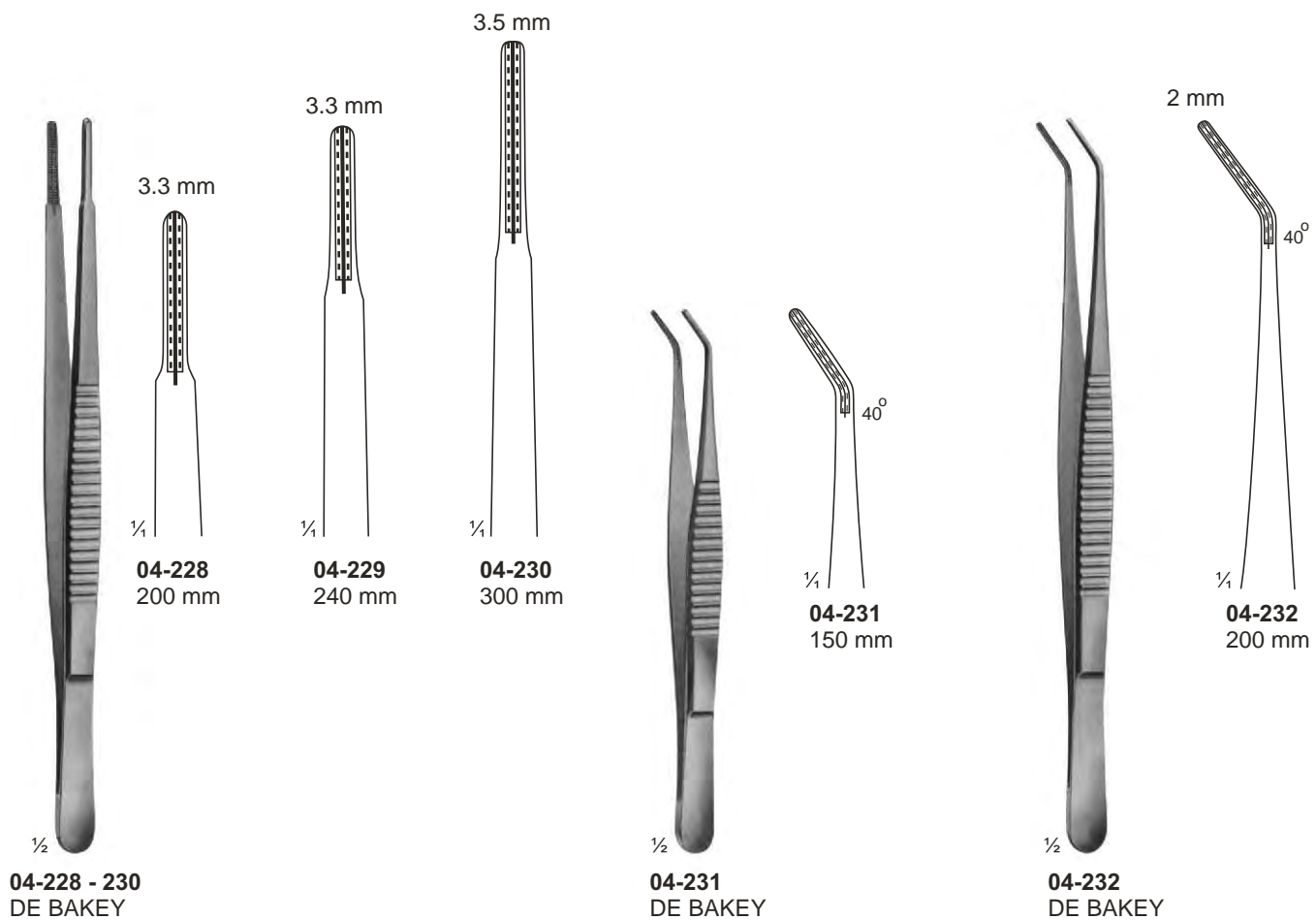
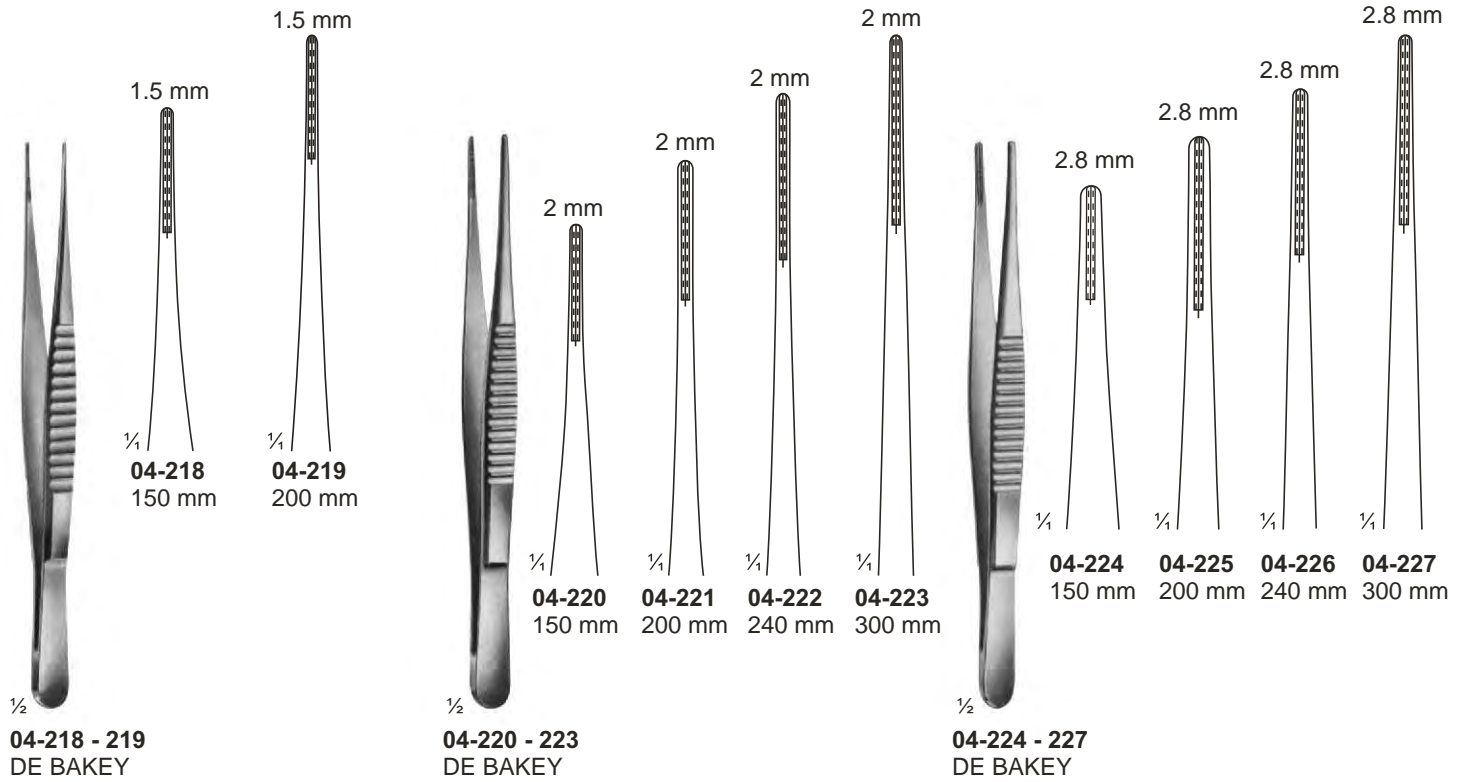

Forceps, Bayonet - Shaped

REALSTAR SURGICAL INSTRUMENTS



04-233
LUCAE
140 mm



04-234
LUCAE
1x2 teeth
140 mm



04-235
COTTLE
Forceps with
jaws toothed
and serrated
140 mm



04-236
JANSEN
160 mm

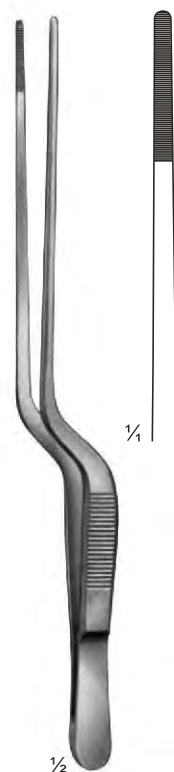

04-237
GRUENWALD
200 mm



04-238
1x2 teeth
200 mm

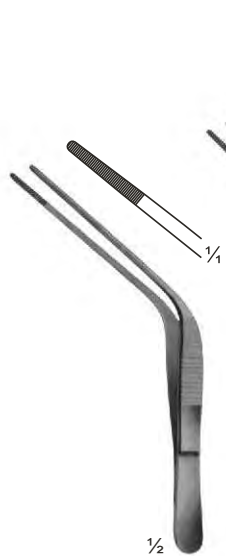

04-239
TROELTSCH
100 mm

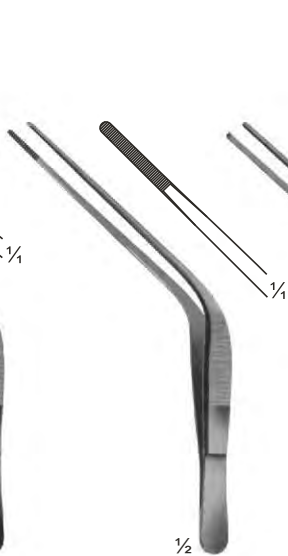

04-240
TROELTSCH
115 mm

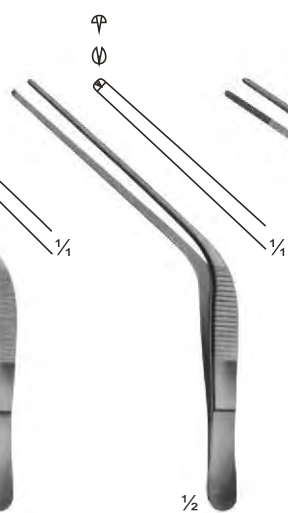

04-241
TROELTSCH
1X2 teeth
115 mm

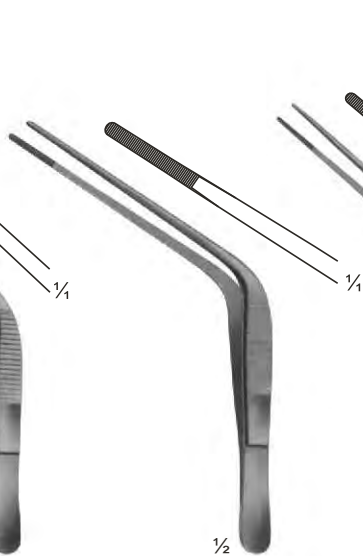

04-242
WILDE
115 mm

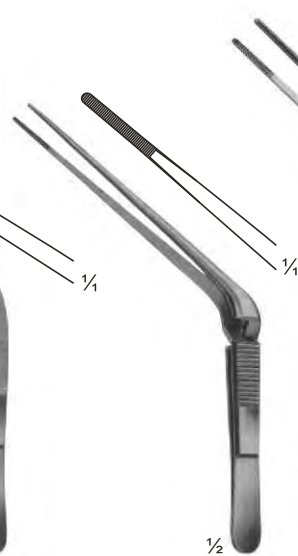

04-243
TROELTSCH
Cross action
120 mm

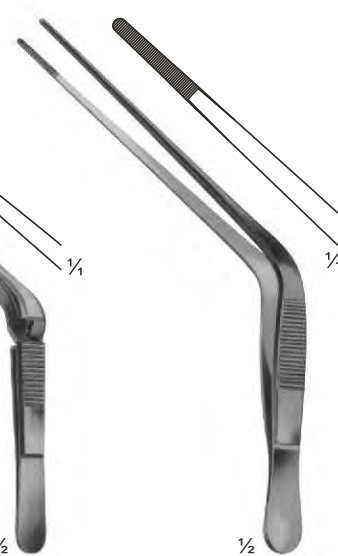

04-244
TROELTSCH
140 mm

Delicate Tissue Forceps

REALSTAR SURGICAL INSTRUMENTS

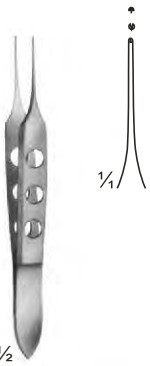

04-245
BISHOP-HARMON
85 mm

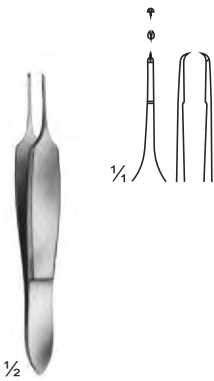

04-246
ST. MARTIN
80 mm

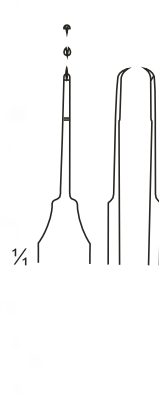

04-247
CASTROVIEJO
teeth 0.9 mm
100 mm

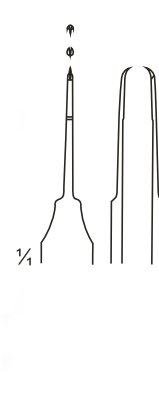

04-248
CASTROVIEJO
teeth 0.5 mm
100 mm

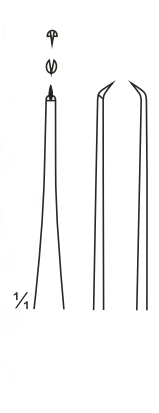

04-249
ELSCHING
110 mm

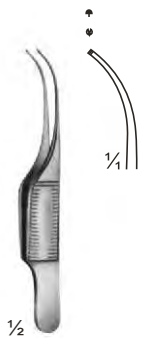

04-250
GILL
75 mm

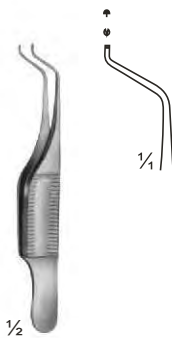

04-251
GILL - HESS
75 mm

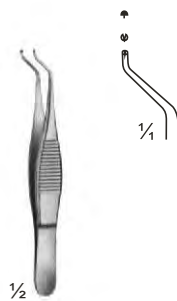

04-252
HESS
70 mm

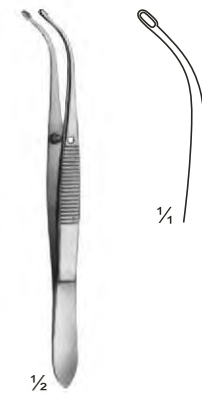

04-253
ARRUGA
100 mm

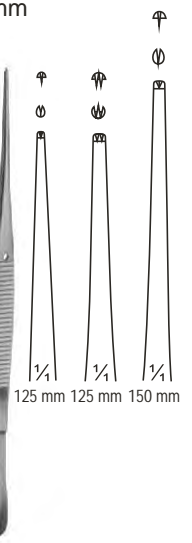

04-254
SEMKEN

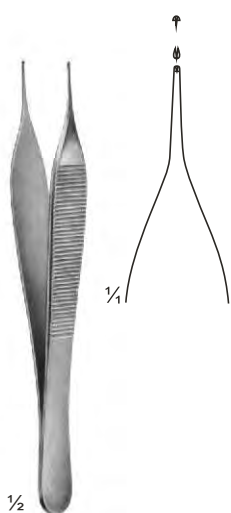

04-255
MICRO-ADSON
120 mm

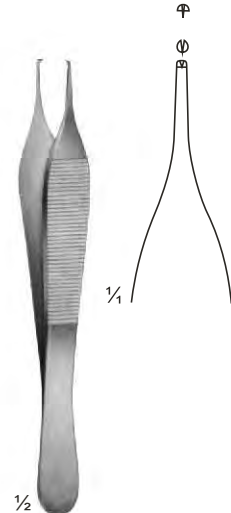

04-256
ADSON
120 mm

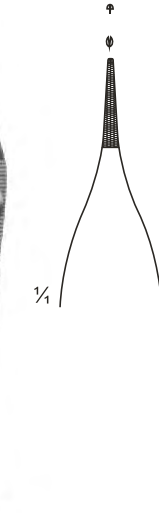

04-257
ADSON
120 mm



04-258
ADSON
120 mm

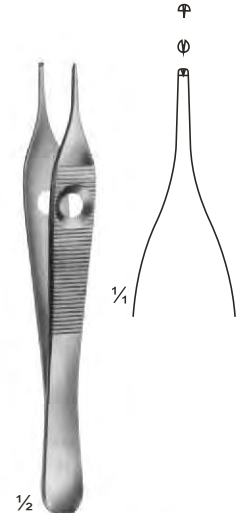

04-259
ADSON
150 mm

Tissue Forceps

REALSTAR SURGICAL INSTRUMENTS

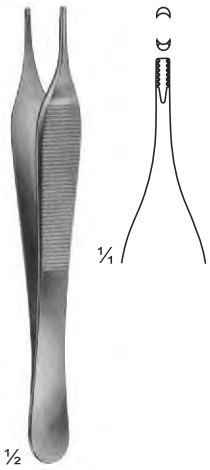

04-260
ADSON - BROWN
Non-traumatic
120 mm

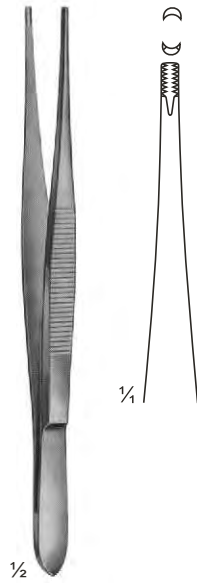

04-261
BROWN
120 mm

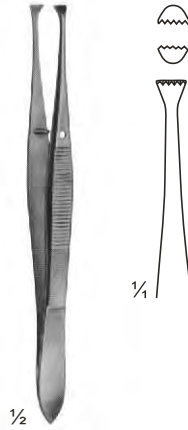

04-262
GRAEFE
110 mm

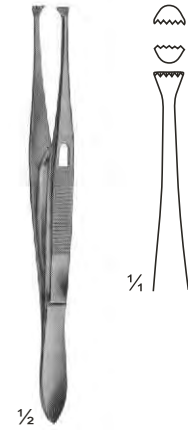

04-263
GRAEFE
With Catch
110 mm

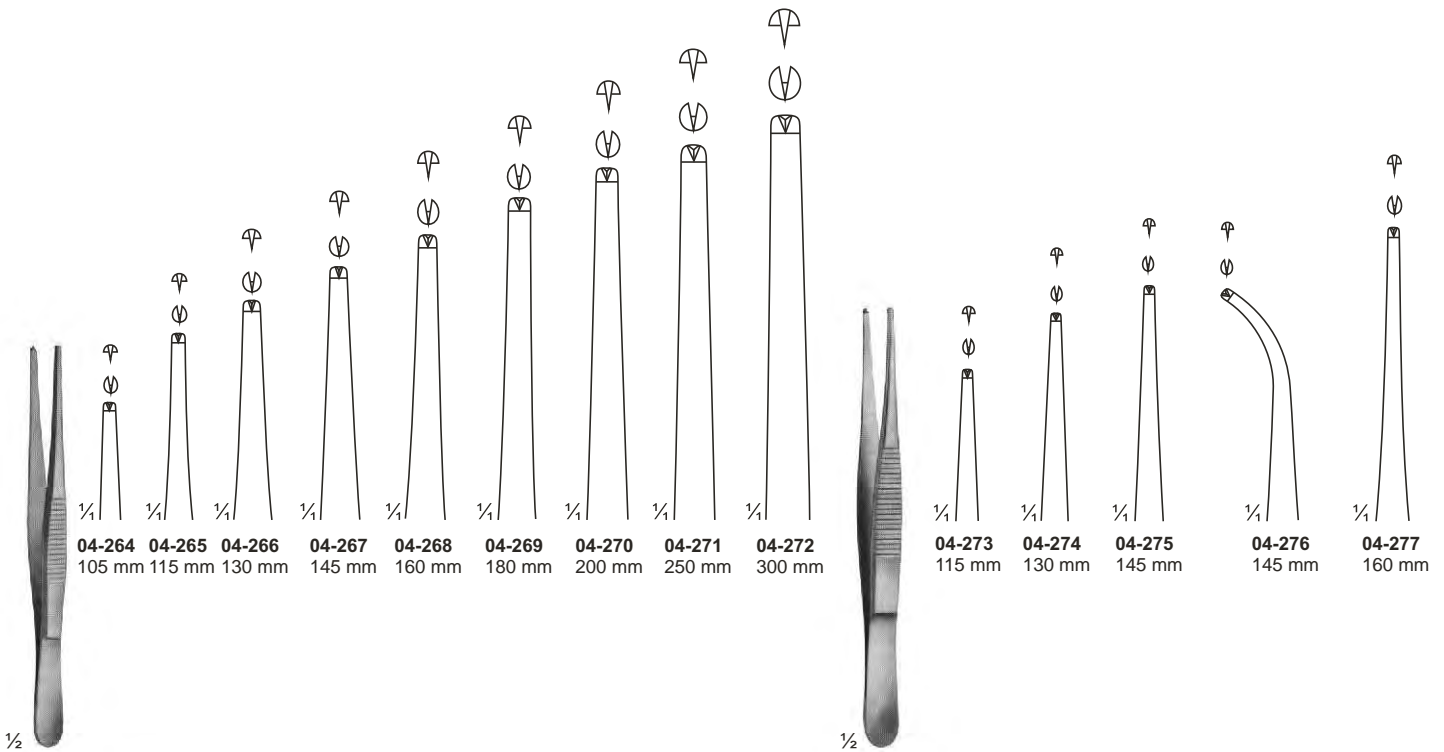

04-264 - 272
STANDARD

04-273 - 277
GRAEFE
110 mm

Tissue Forceps

REALSTAR SURGICAL INSTRUMENTS

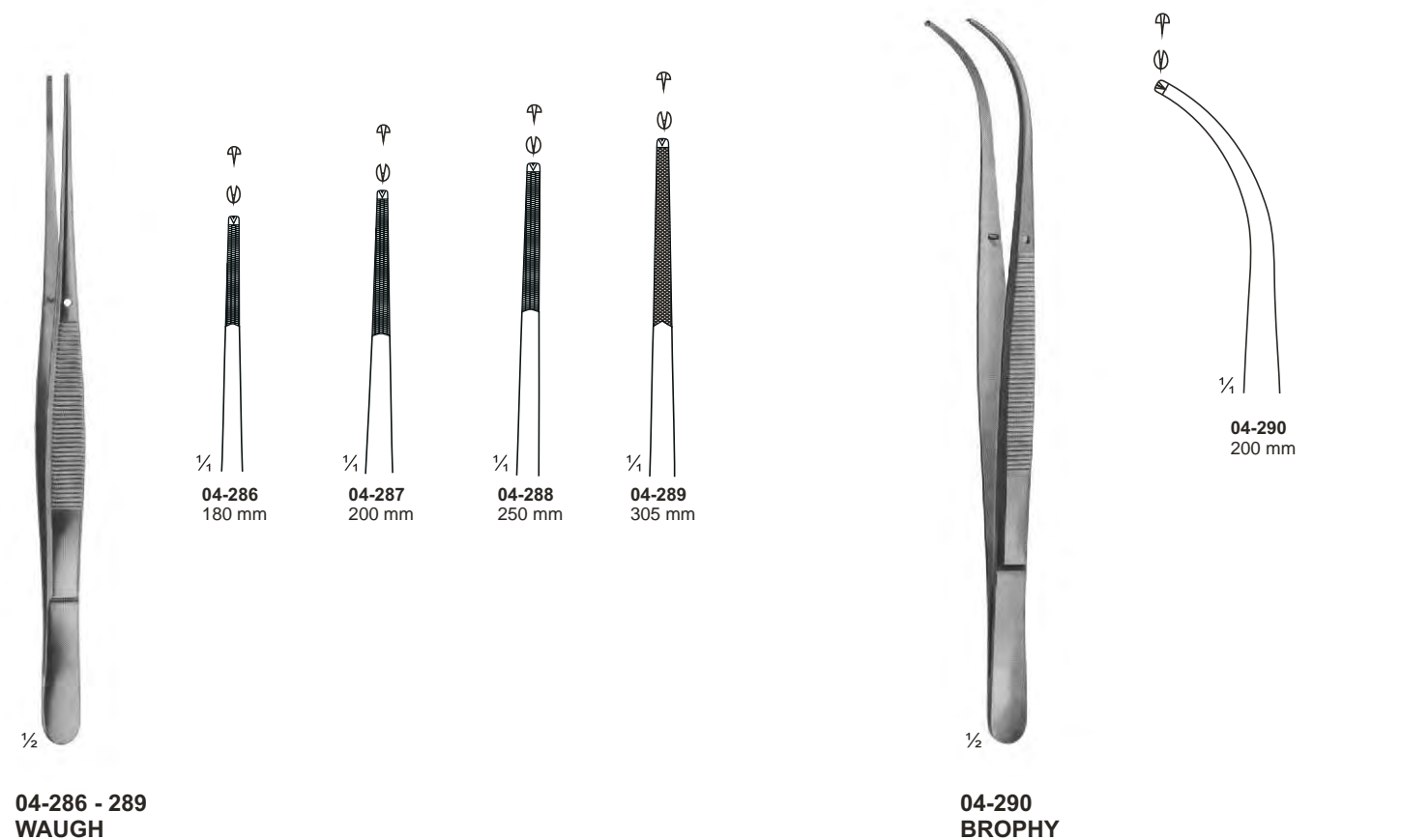
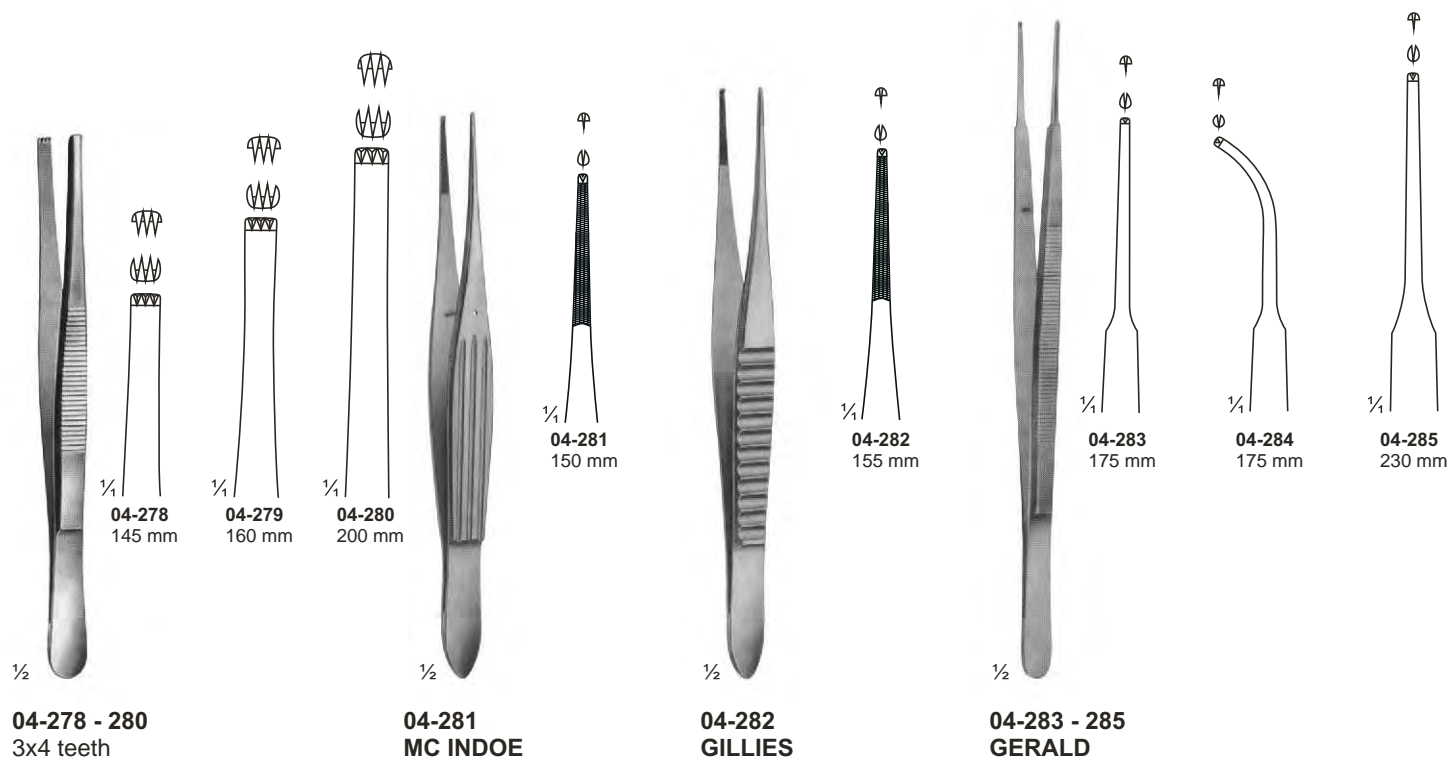

Tissue Forceps, Lung Dissecting Forceps

REALSTAR SURGICAL INSTRUMENTS

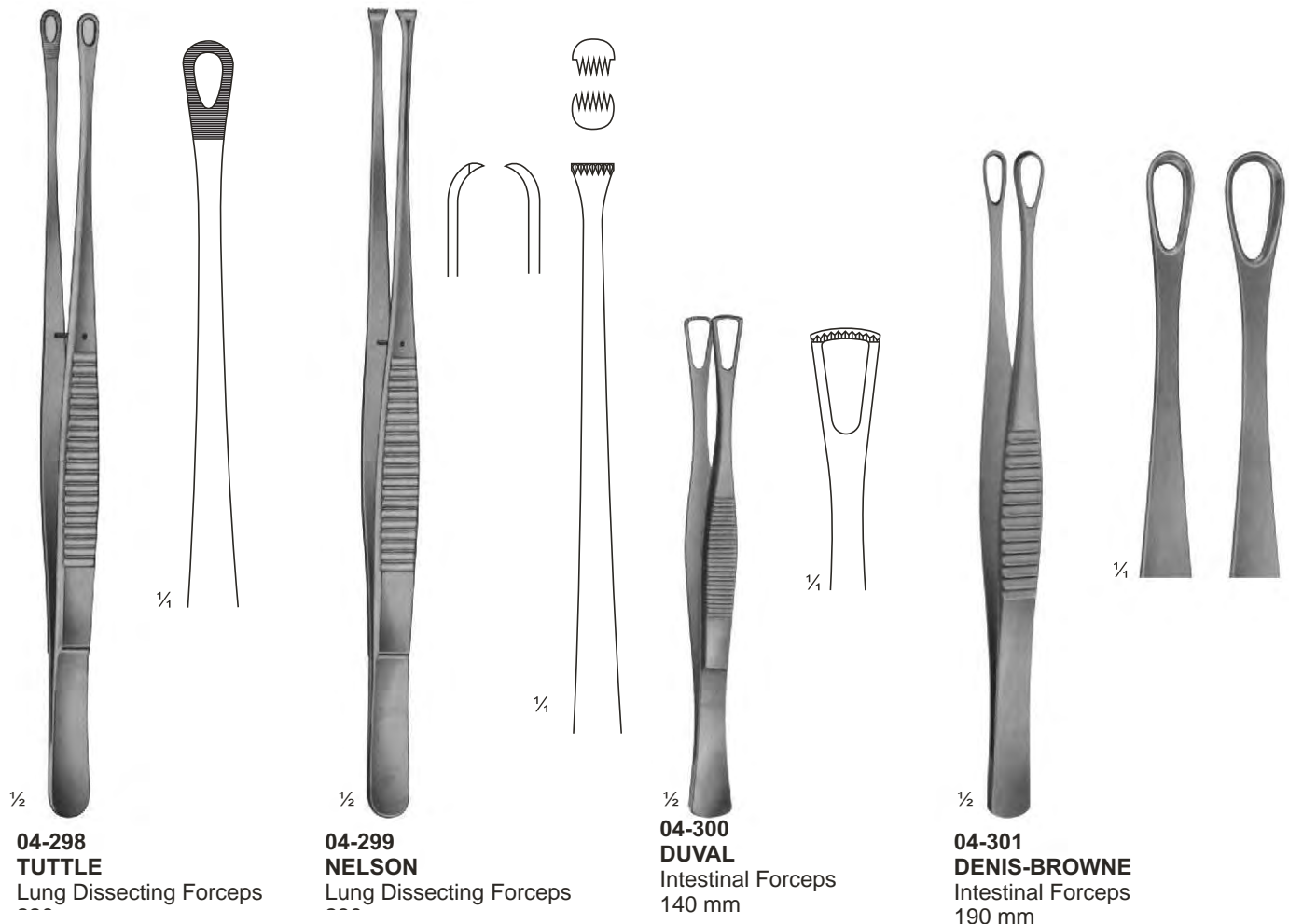
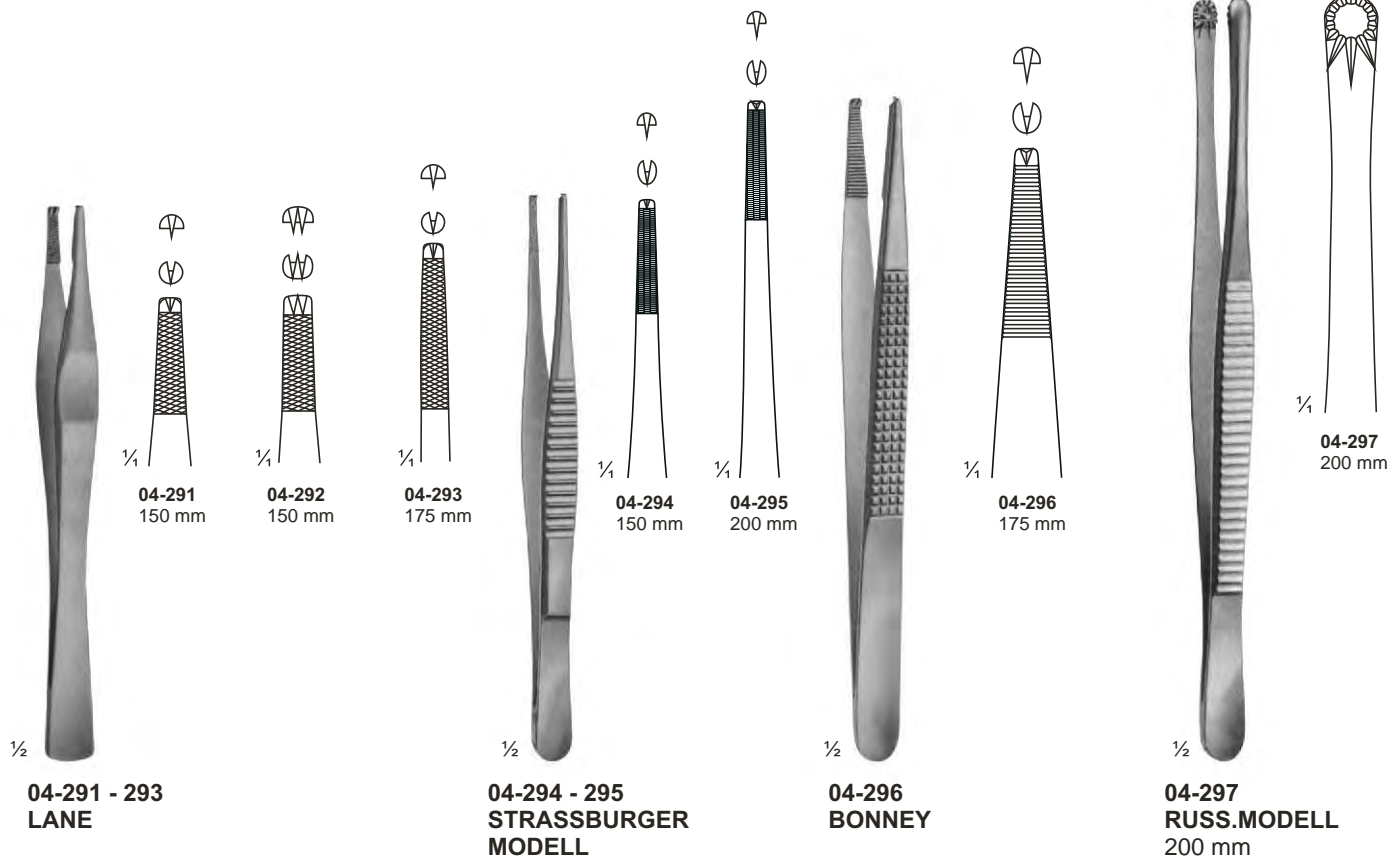

Splinter and Cilia Forceps

REALSTAR SURGICAL INSTRUMENTS

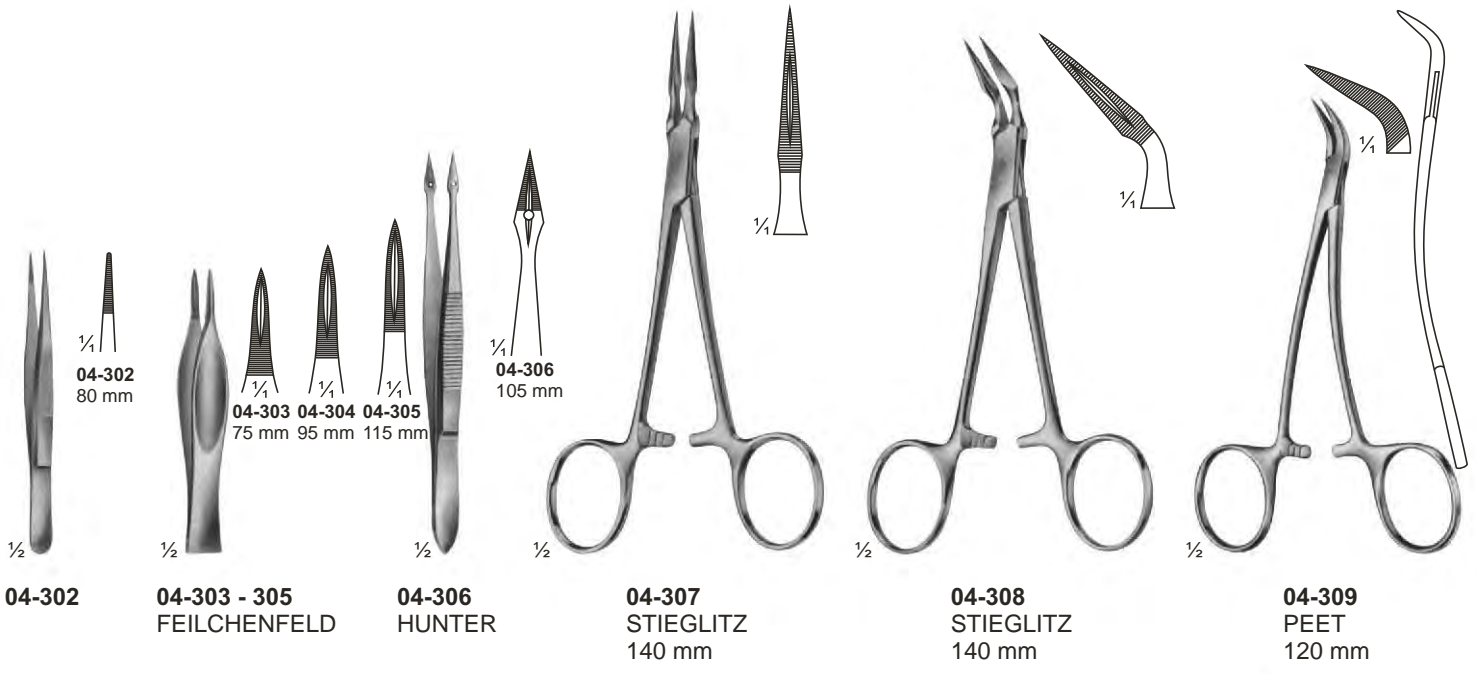

04-302

04-303 - 305
FEILCHENFELD

04-306
HUNTER

04-307
STIEGLITZ
140 mm

04-308
STIEGLITZ
140 mm

04-309
PEET
120 mm

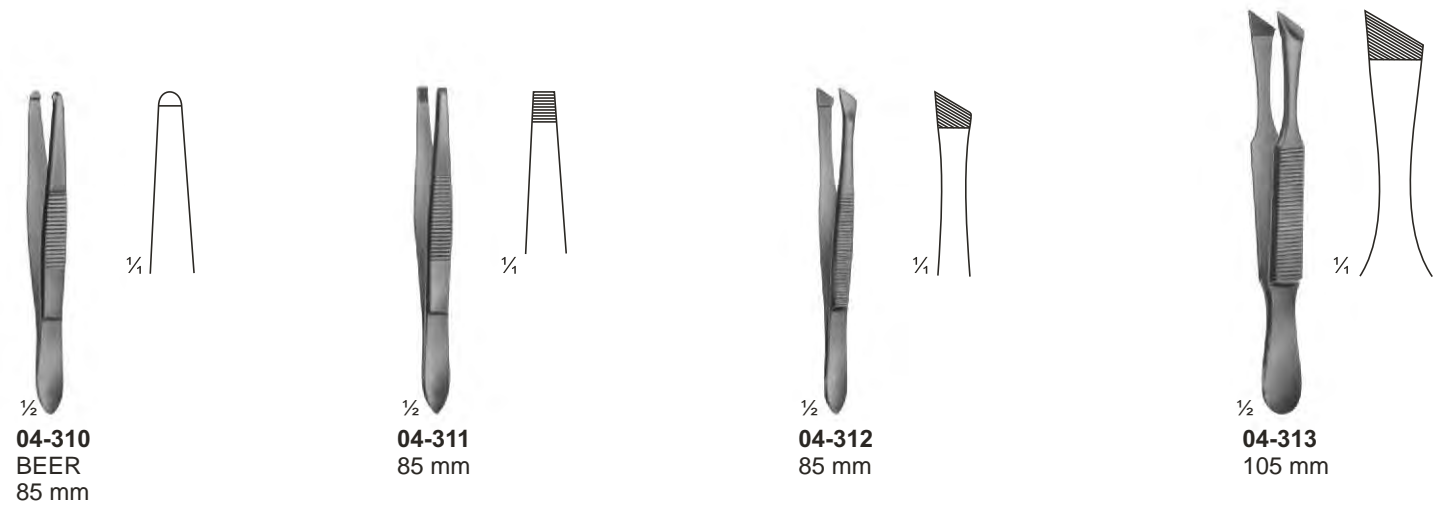

04-310
BEER
85 mm

04-311
85 mm

04-312
85 mm

04-313
105 mm



04-314
105 mm

04-315
SAUPE
105 mm

04-316
SCHAAF
95 mm

04-317
105 mm

Sponge and Dressing Forceps

REALSTAR SURGICAL INSTRUMENTS

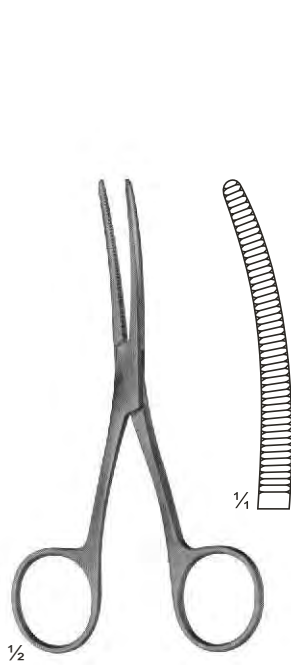

04-318
BRYANT
130 mm

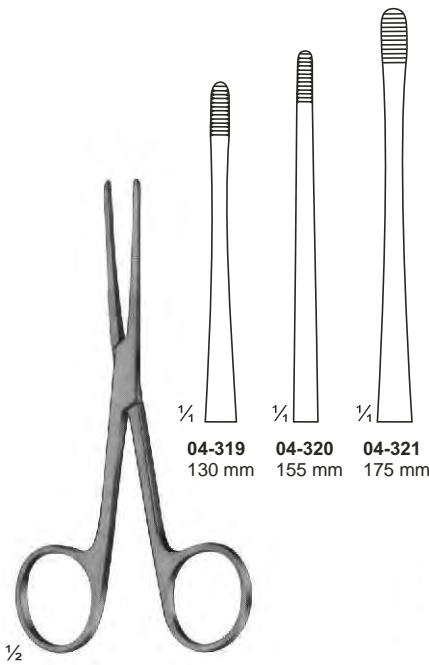

04-319 - 321
LISTER
Sinus Forceps

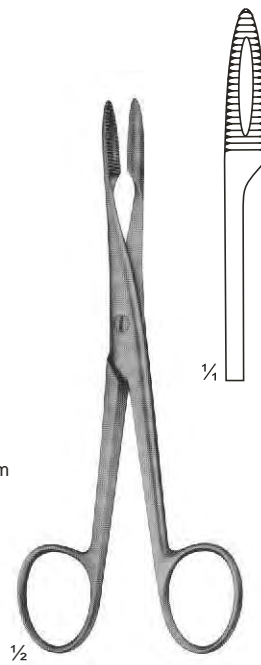

04-322
Without Ratchet
145 mm

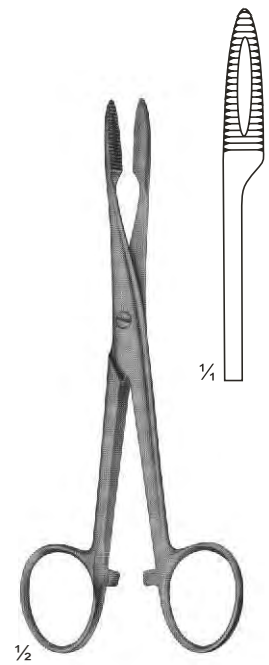

04-323
With Ratchet
145 mm

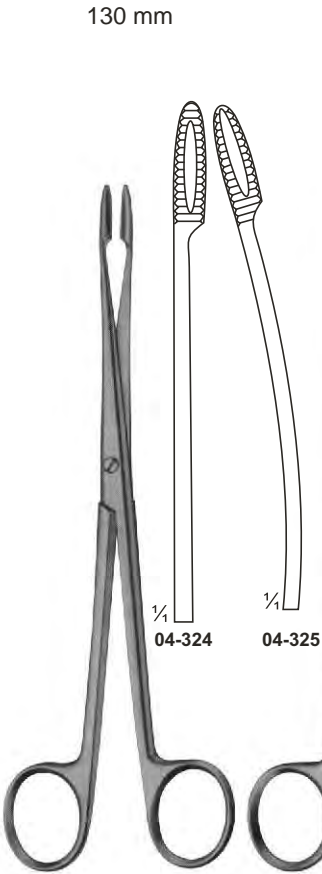

04-324 - 325
GROSS
Without Ratchet
200 mm

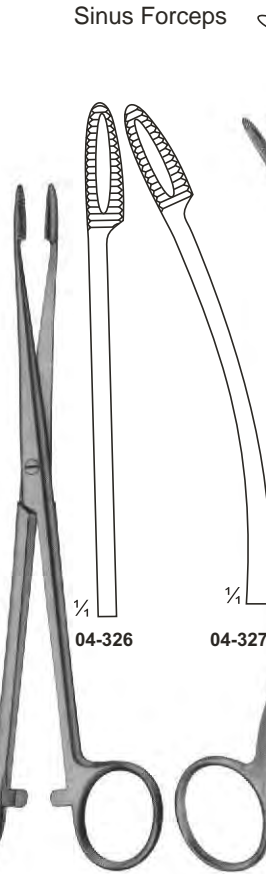

04-326 - 327
GROSS
With Ratchet
180 mm

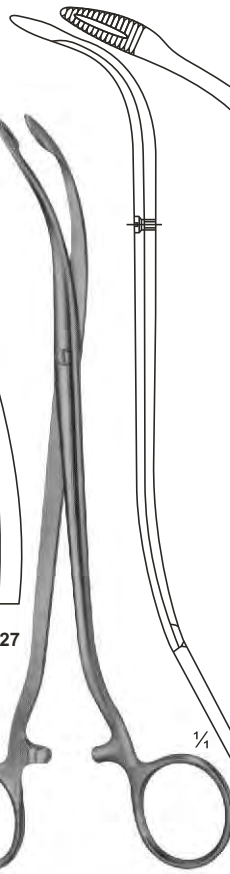

04-328
DUPLAY
190 mm

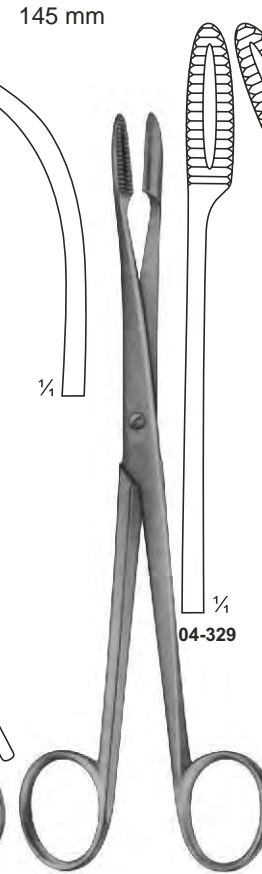

04-329 - 330
GROSS
Without Ratchet
200 mm

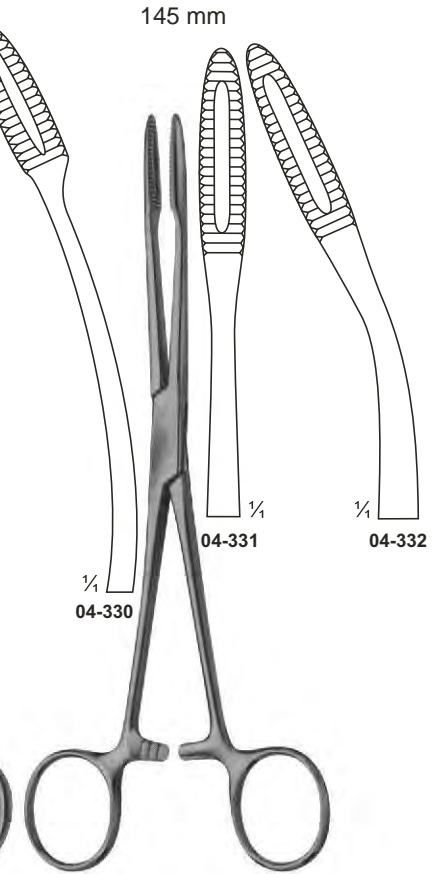

04-331 - 332
GROSS
With Ratchet
200 mm

Sponge and Dressing Forceps

REALSTAR SURGICAL INSTRUMENTS



04-333 - 334
AESCULAP
220 mm

04-335 - 336
MAIER
Without Ratchet
265 mm

04-337 - 338
MAIER
With Ratchet
265 mm

Sponge and Dressing Forceps

REALSTAR SURGICAL INSTRUMENTS

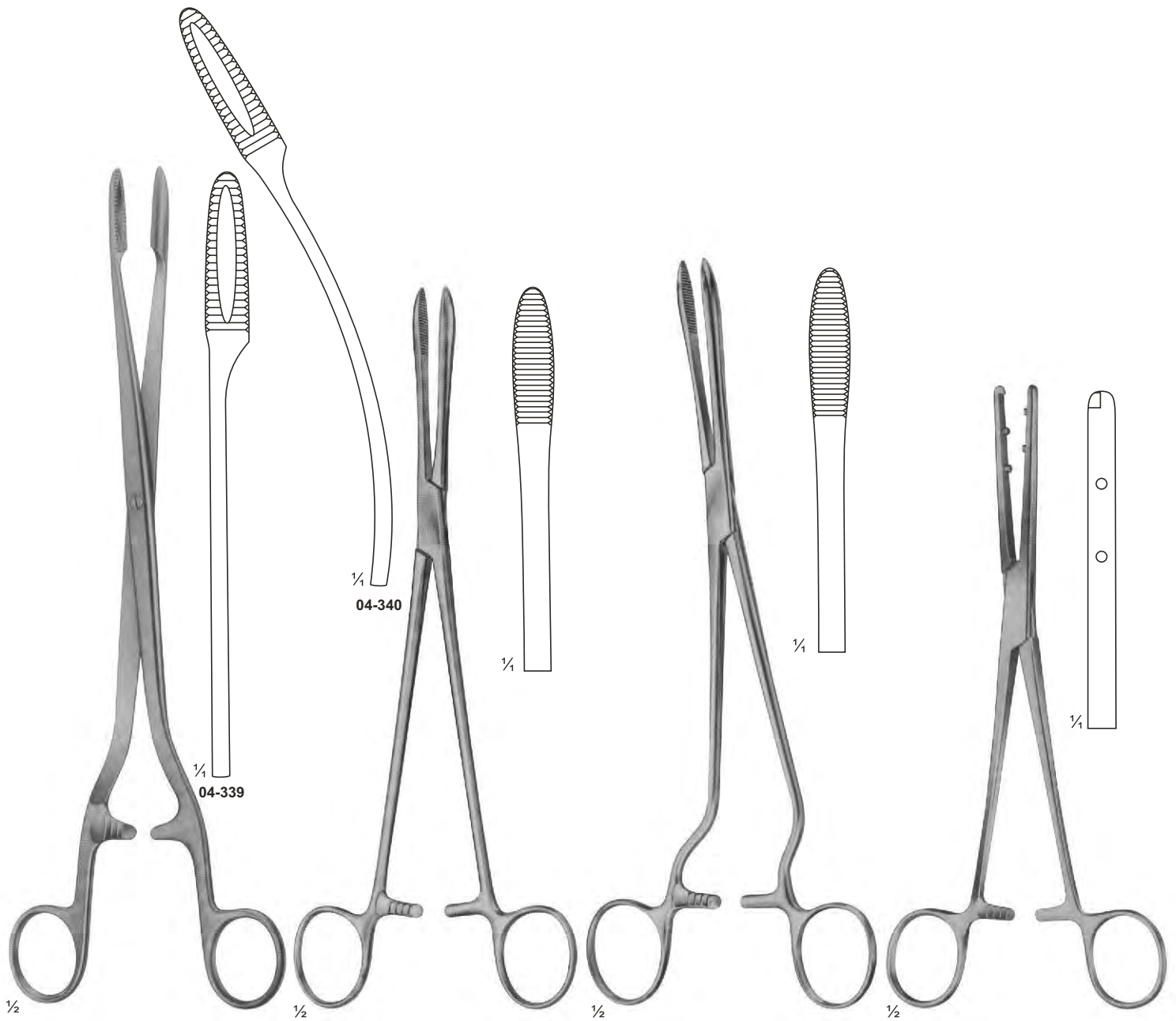

04-339 - 340
SIMS-MAIER
280 mm

04-341
COLLIN
240 mm

04-342
CHERON
Handles Laterally Angled
240 mm

04-343
EMMET
210 mm

Dressing, Sponge holding, Organ and Tissue Grasping Forceps

REALSTAR SURGICAL INSTRUMENTS

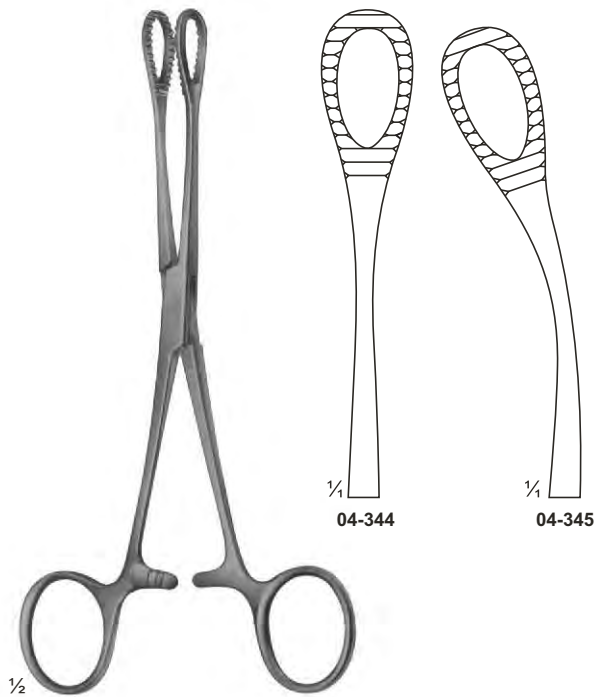

04-344

04-345

1/2
04-344 - 345
FOERSTER-BALLENGER
180 mm

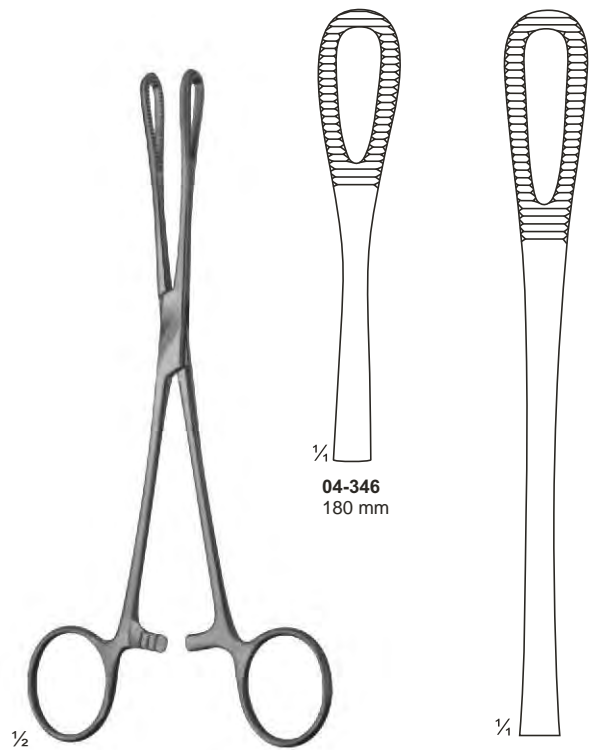

1/4
04-346
180 mm

1/4
04-347
250 mm

1/2
04-346 - 347
RAMPLEY

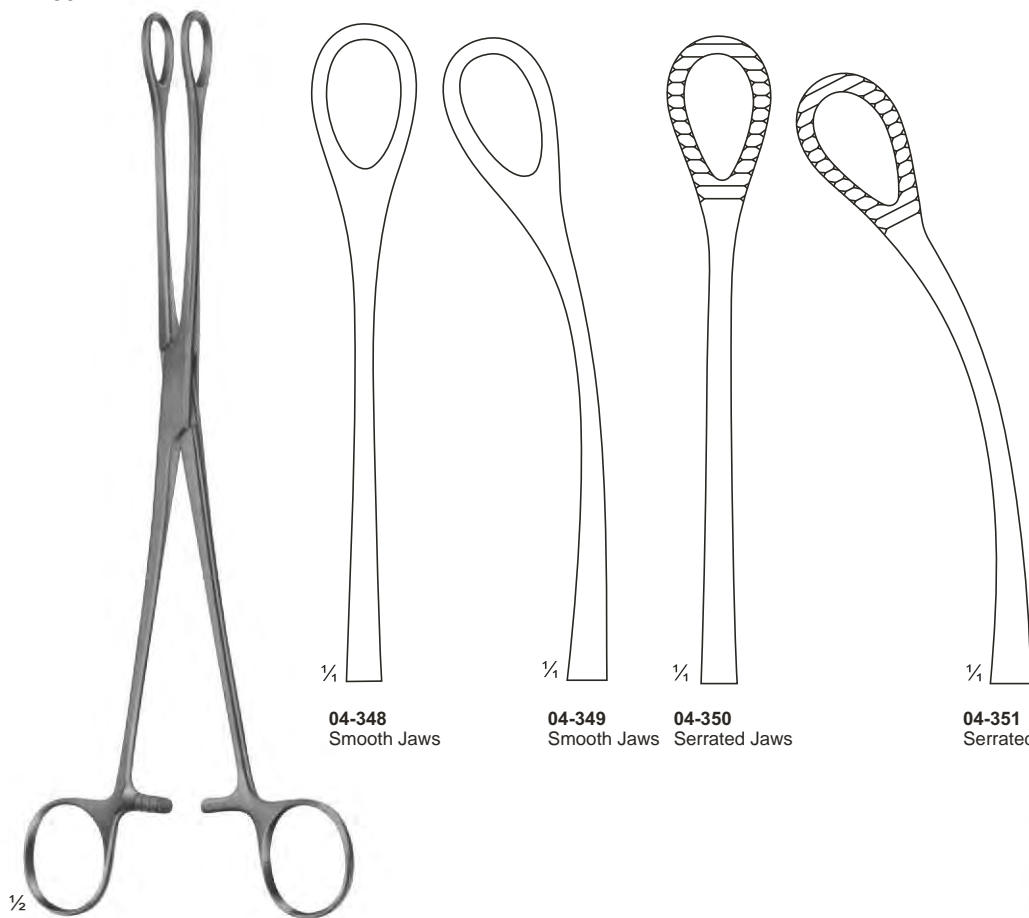

1/4
04-348
Smooth Jaws

1/4
04-349
Smooth Jaws

1/4
04-350
Serrated Jaws

1/4
04-351
Serrated Jaws

1/2
04-348 - 351
FOERSTER-BALLENGER
240 mm

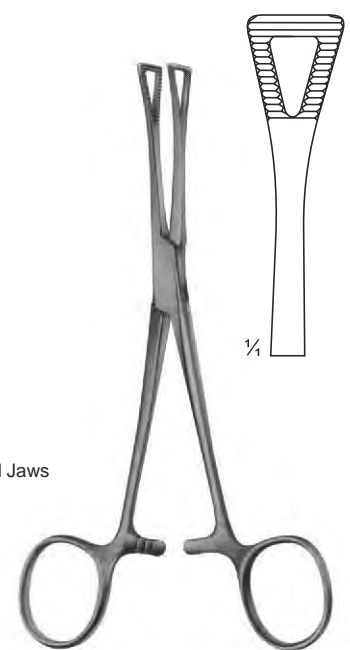

1/4
04-352
PENNINGTON
155 mm

Dressing, Sponge holding, Organ and Tissue Grasping Forceps

REALSTAR SURGICAL INSTRUMENTS

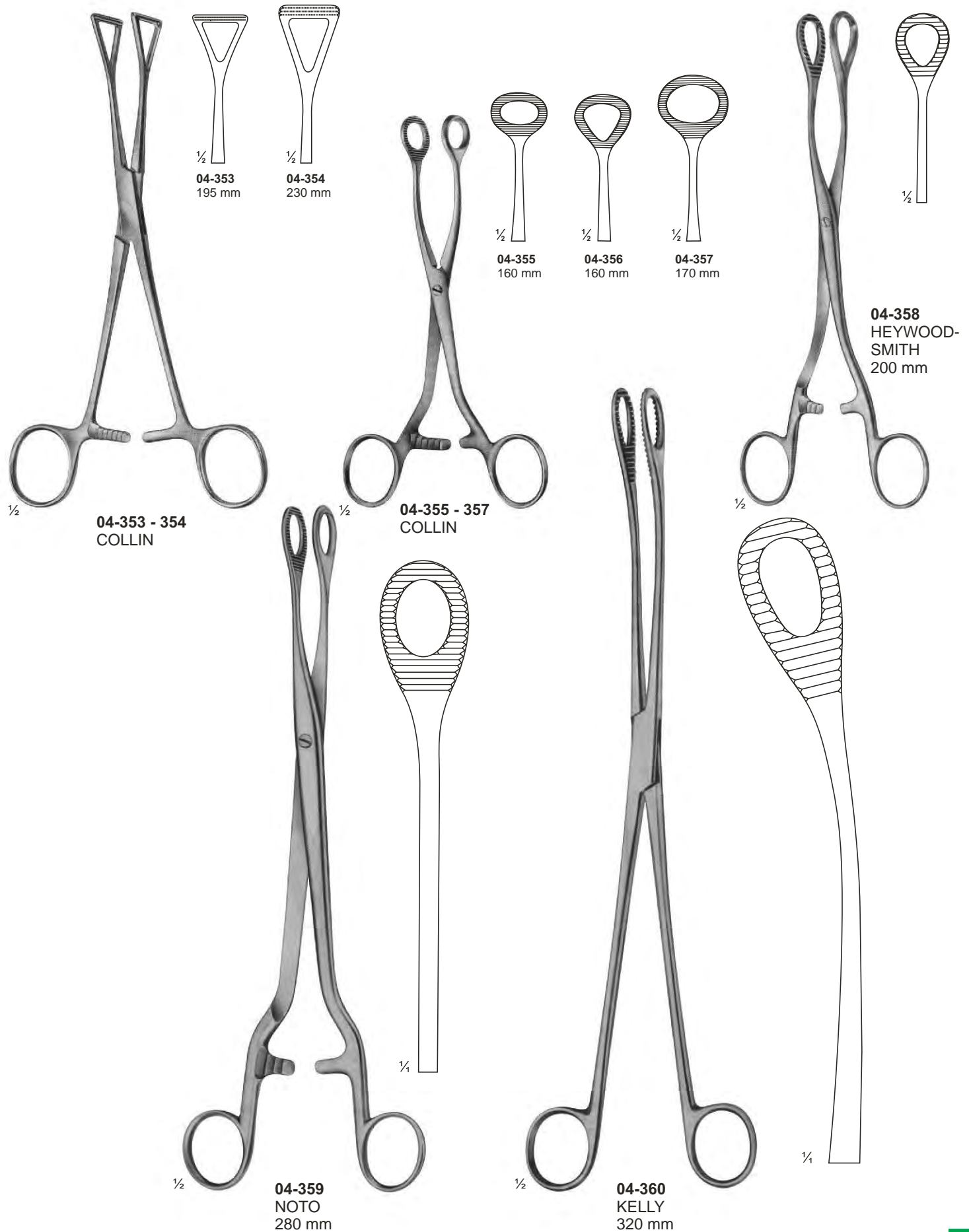

Tendon Seizing Forceps

REALSTAR SURGICAL INSTRUMENTS



04-361

04-362

04-361 - 362
HERZ
155 mm



04-363

04-363
JACKSON
4 x 5 teeth
150 mm

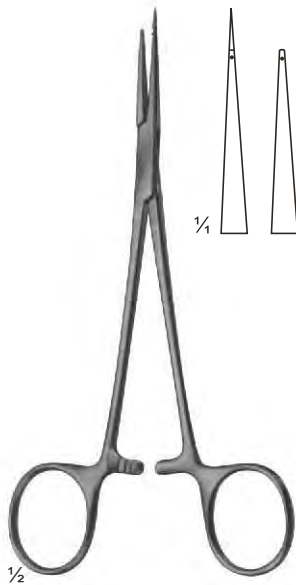

1/4

04-364
150 mm

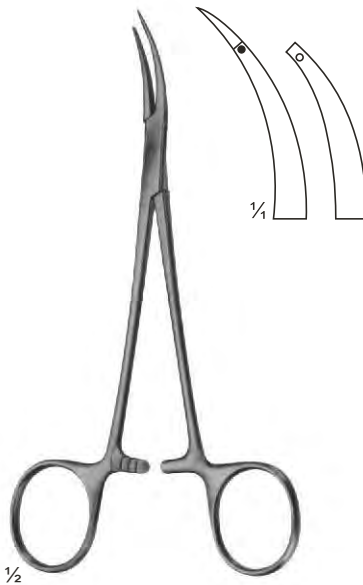

1/4

04-365
150 mm



1/4

04-366
120 mm

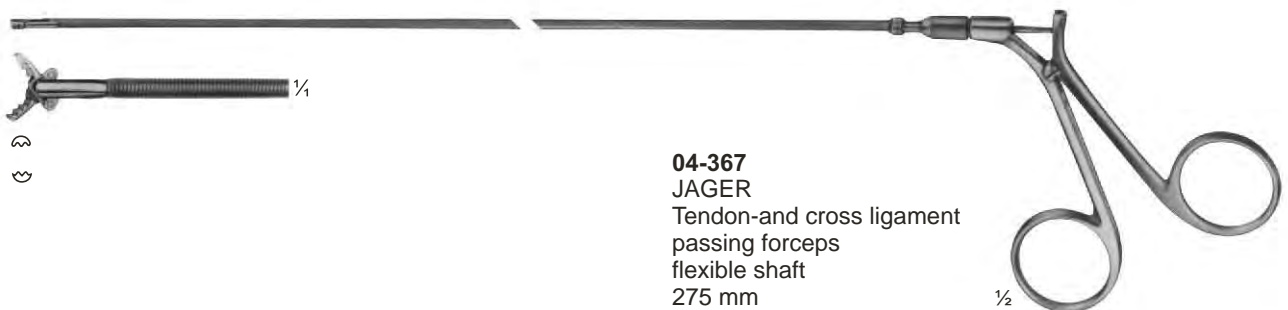

1/4

04-367
JAGER
Tendon-and cross ligament
passing forceps
flexible shaft
275 mm

1/2

Artery Traction - and Tissue Grasping Forceps

REALSTAR SURGICAL INSTRUMENTS

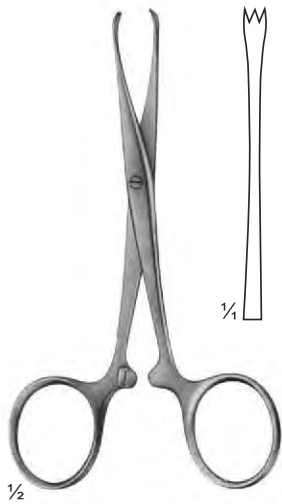

04-368
CHAPUT
2 x 3 teeth
125 mm

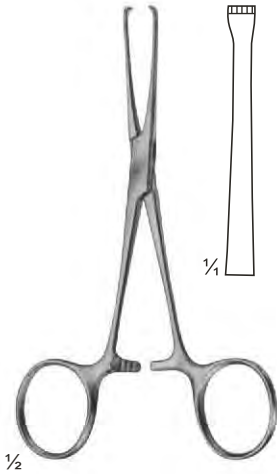

04-369
BABY-ALLIS
4 x 5 teeth
130 mm

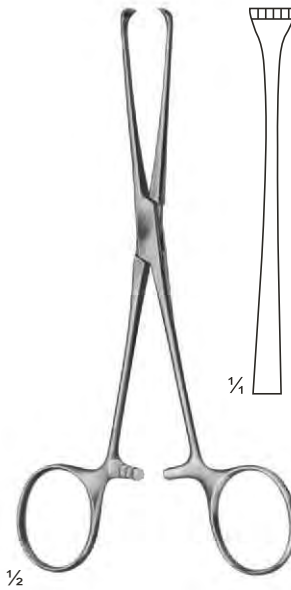

04-370
BOYS-ALLIS
5 x 6 teeth
155 mm

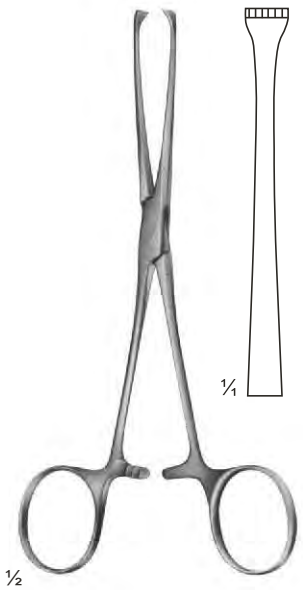

04-371
ALLIS
5 x 6 teeth
155 mm

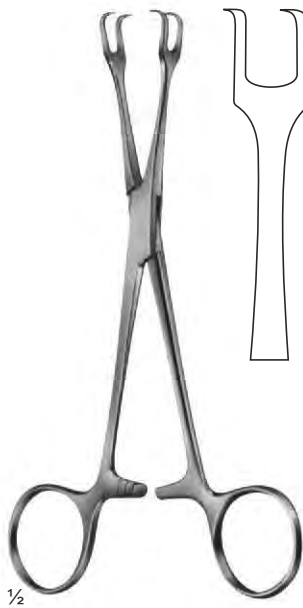

04-372
LAHEY
135 mm

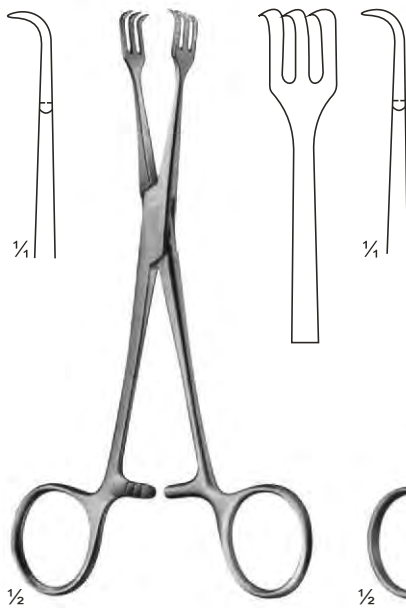

04-373
LAHEY
135 mm

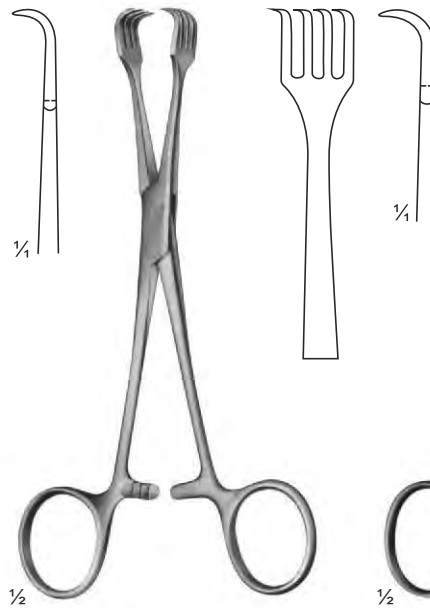

04-374
BRAUN
155 mm

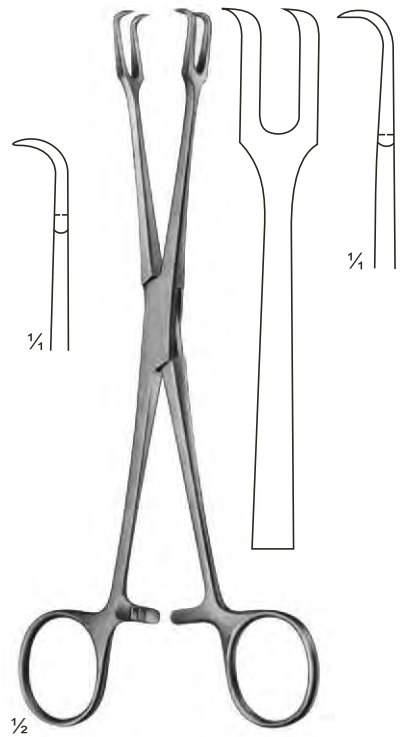

04-375
MUSEUX
200 mm

Organ - and Tissue Grasping Forceps

**REALSTAR SURGICAL
INSTRUMENTS**

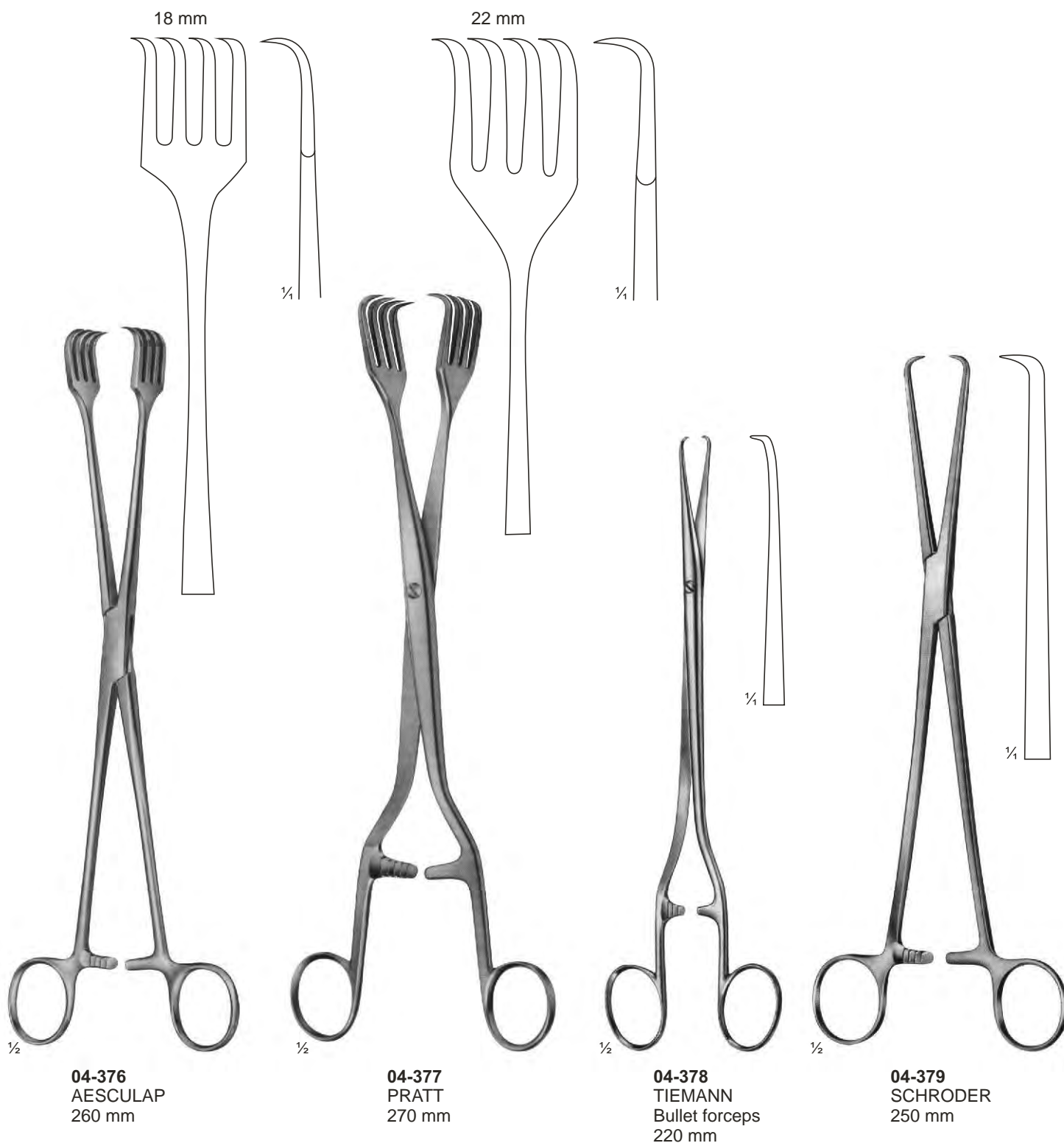

Towel Clamps

REALSTAR SURGICAL INSTRUMENTS

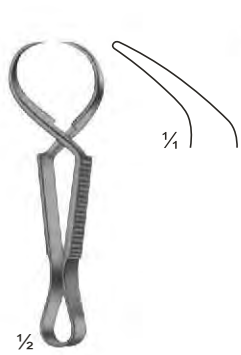

05-101
JONES
85 mm



05-102
ENGL. MOD.
85 mm

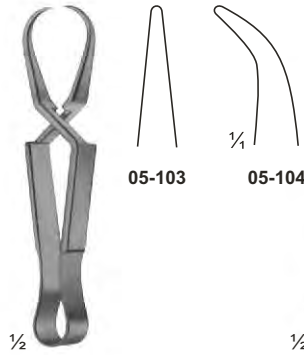

05-103 - 104
SCHAEDEL
85 mm

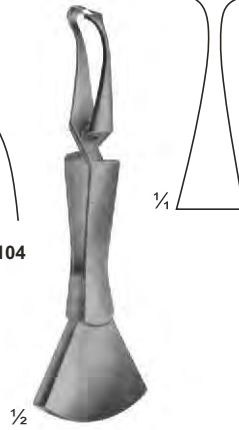

05-105
DOYEN
110 mm



05-106
DOYEN
180 mm

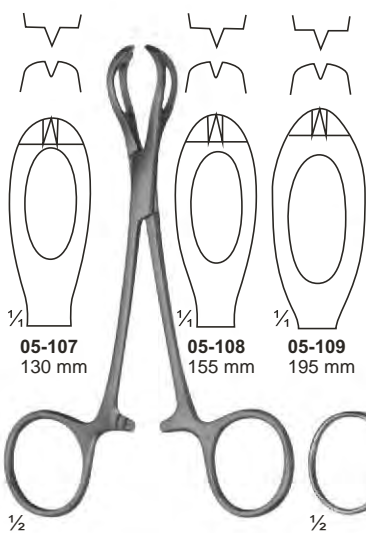

05-107 - 109
LANE

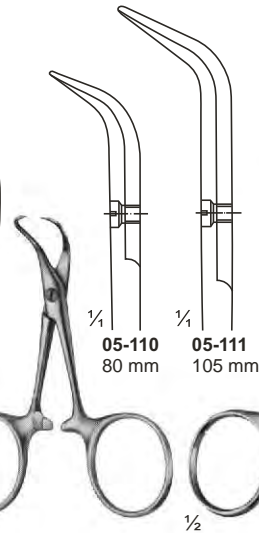

05-110 - 111
BACKHAUS

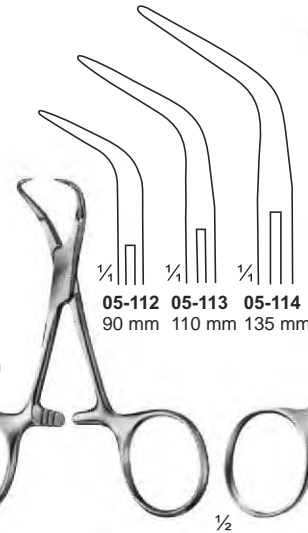

05-112 - 114
BACKHAUS

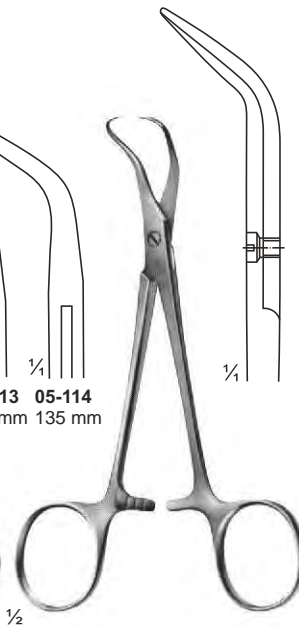

05-115
BACKHAUS-KOCHER
135 mm

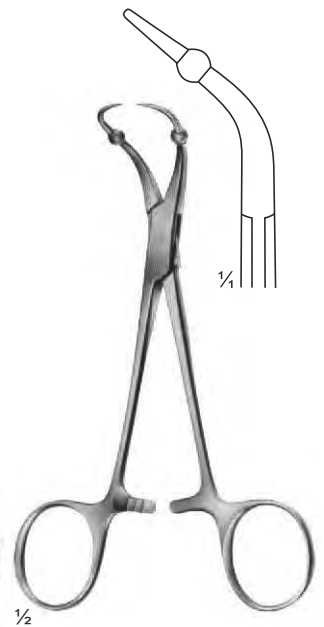

05-116
ROEDER
135 mm

Towel Clamps

REALSTAR SURGICAL INSTRUMENTS

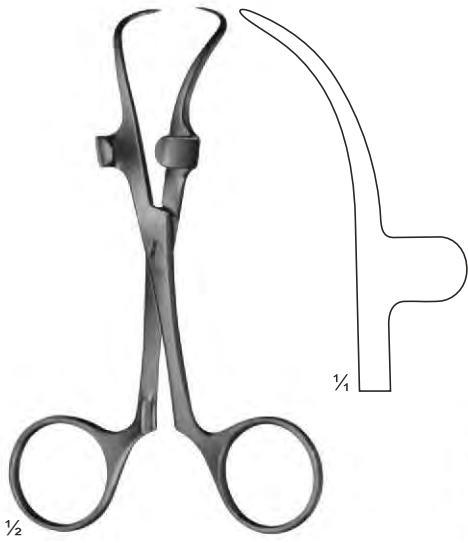

05-117
ROBIN
 with holders for tubing
 up to 13 mm
 135 mm

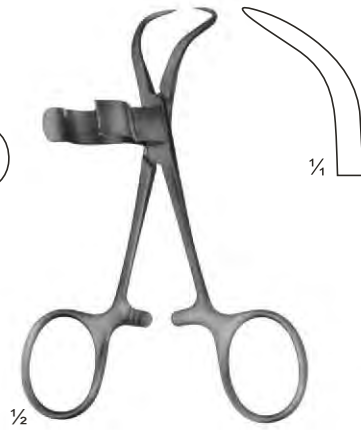

05-118
 with clip for tubing
 up to 15 mm
 110 mm

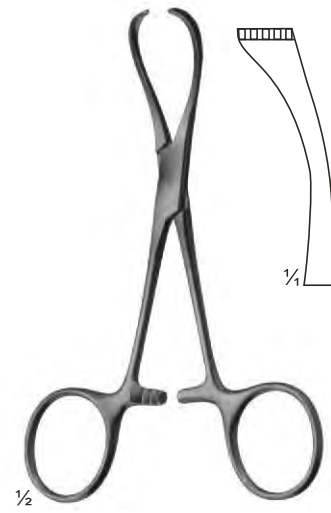

05-119
LORNA
 non perforating
 130 mm

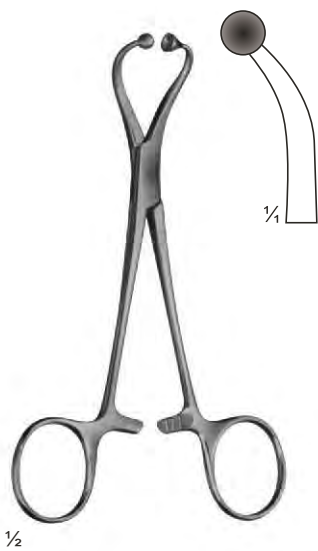

05-120
 for paper cloths
 140 mm



05-121
BUNT
 105 mm



05-122
MAYO
 140 mm

Muller Vessel Clips and Bulldog Clamps

REALSTAR SURGICAL INSTRUMENTS

Closing force

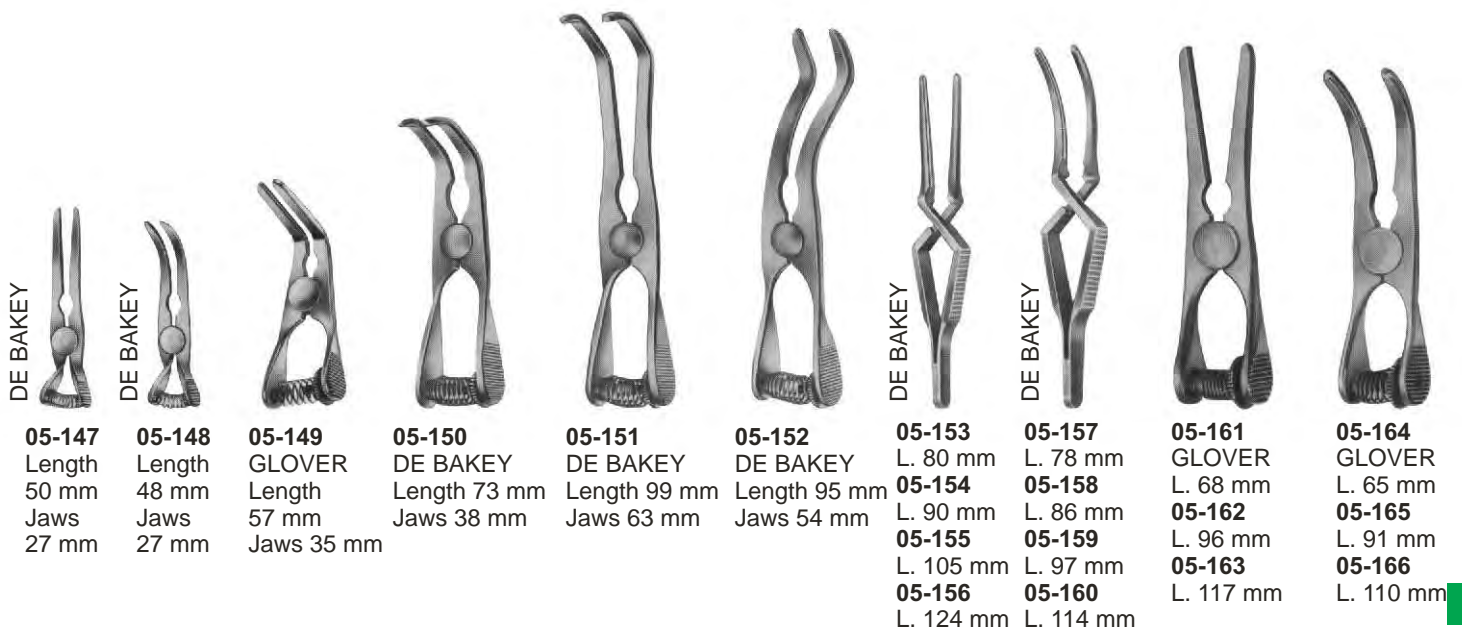
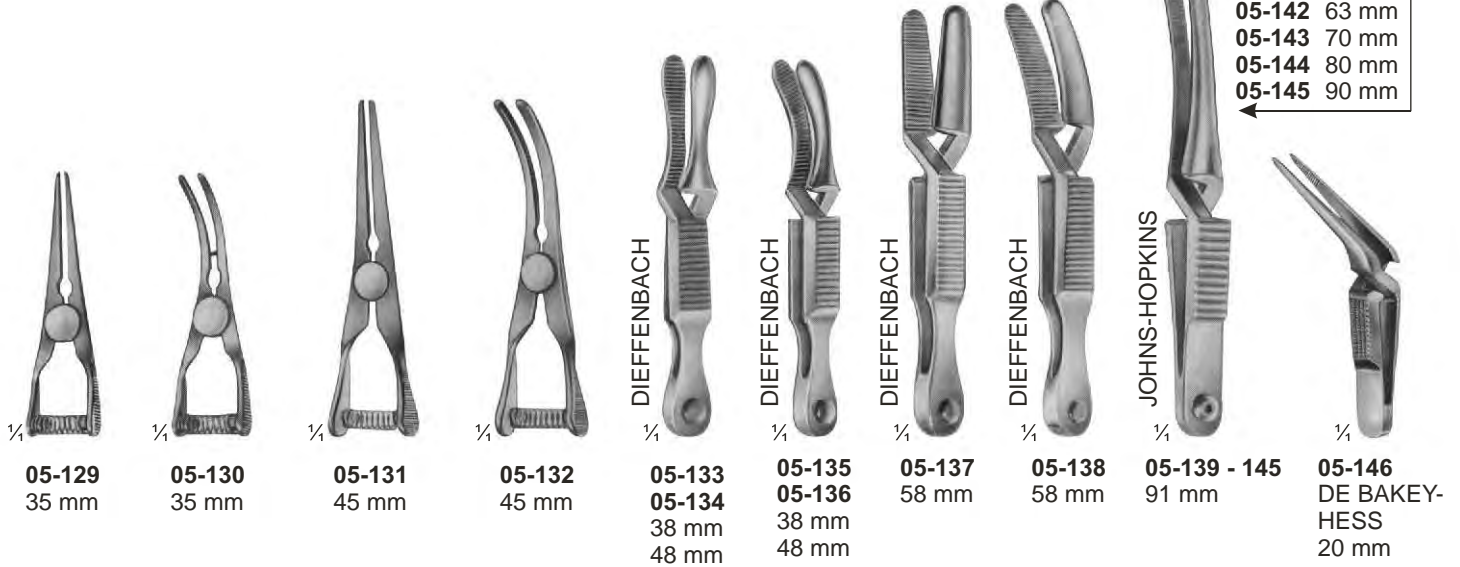
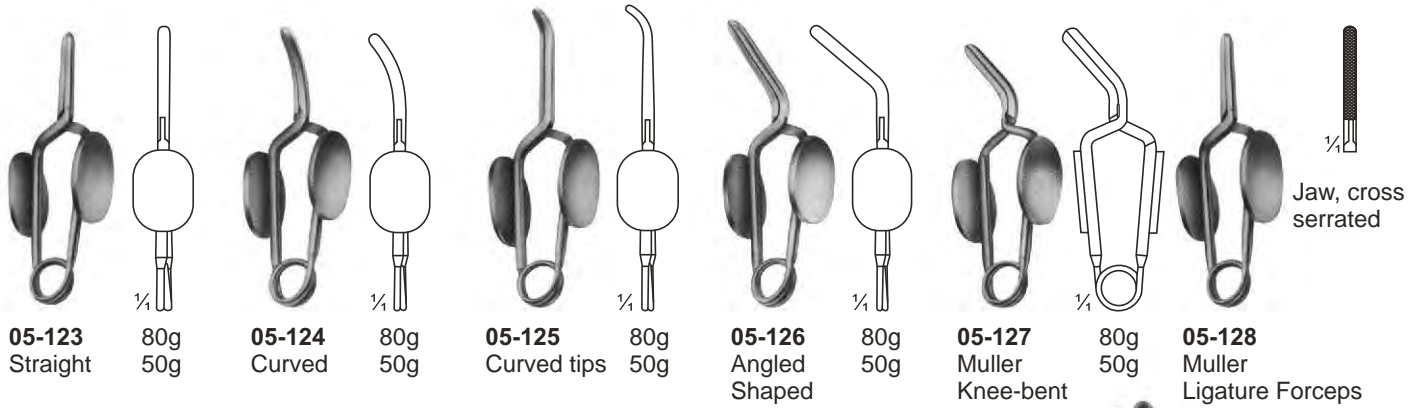

Delicate Haemostatic Forceps

REALSTAR SURGICAL INSTRUMENTS



06-101
CARREL
85 mm



06-102 - 105
BABY-MOSQUITO
(HARTMANN)
100 mm

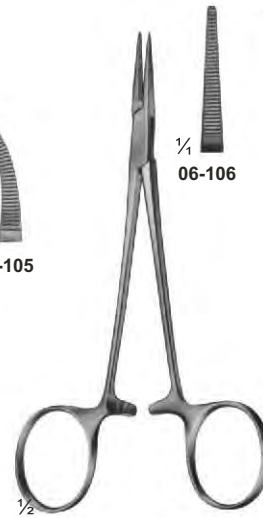
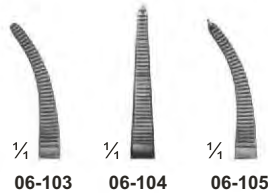

06-106 - 109
MICRO-HALSTED
125 mm

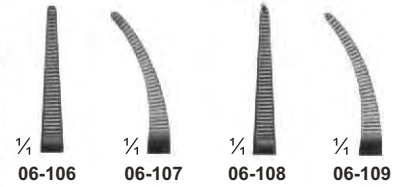

06-110 - 113
HALSTED-MOSQUITO
125 mm

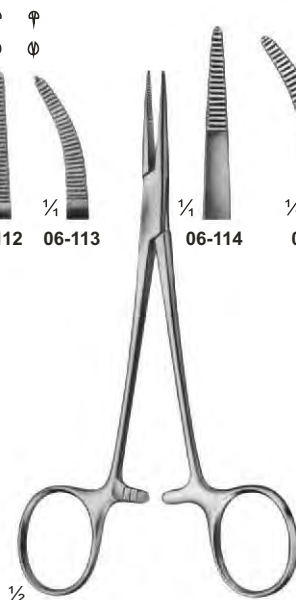

06-114 - 115
PROVIDENCE-HOSPITAL
140 mm

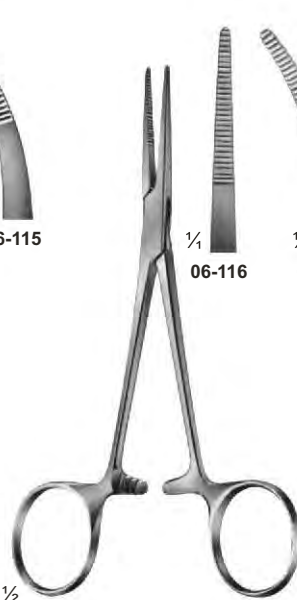

06-116 - 117
KELLY
140 mm

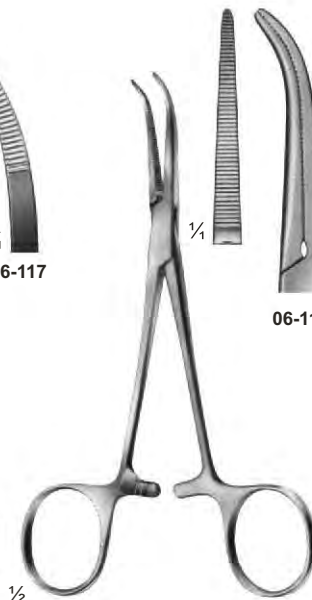

06-118 - 119
DANDY
Curved sideways
140 mm



Delicate Haemostatic Forceps

REALSTAR SURGICAL INSTRUMENTS

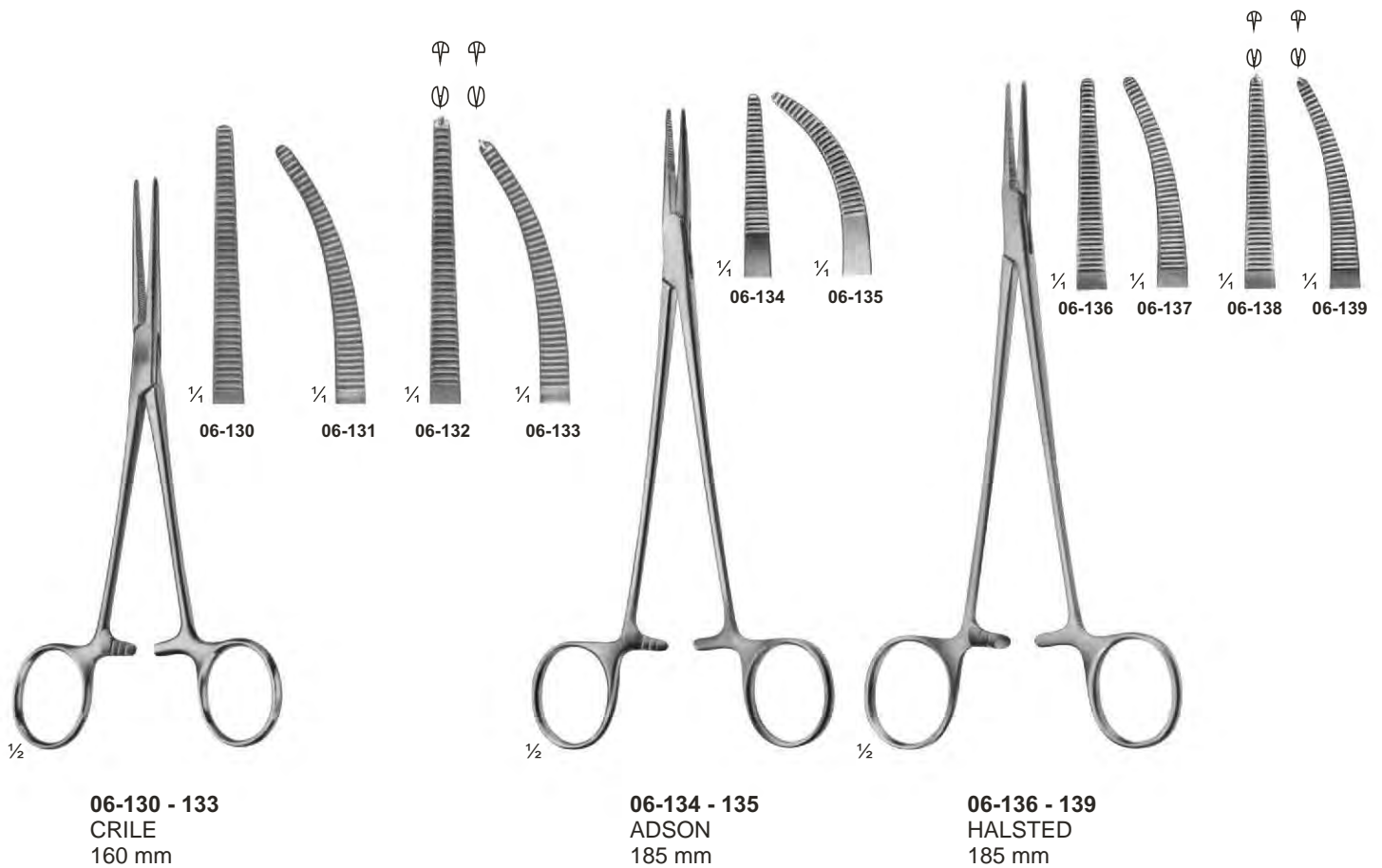
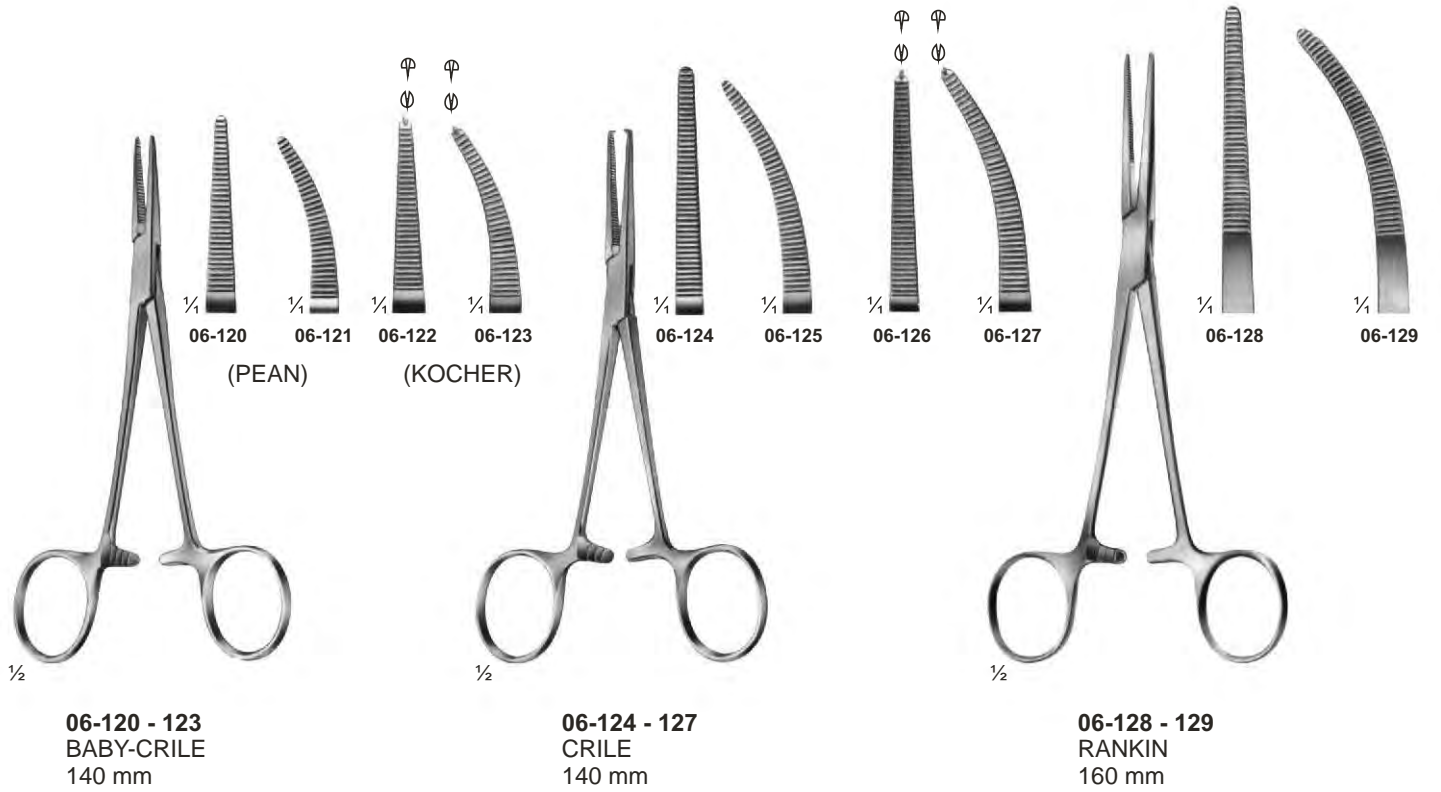

Delicate Haemostatic Forceps

REALSTAR SURGICAL INSTRUMENTS

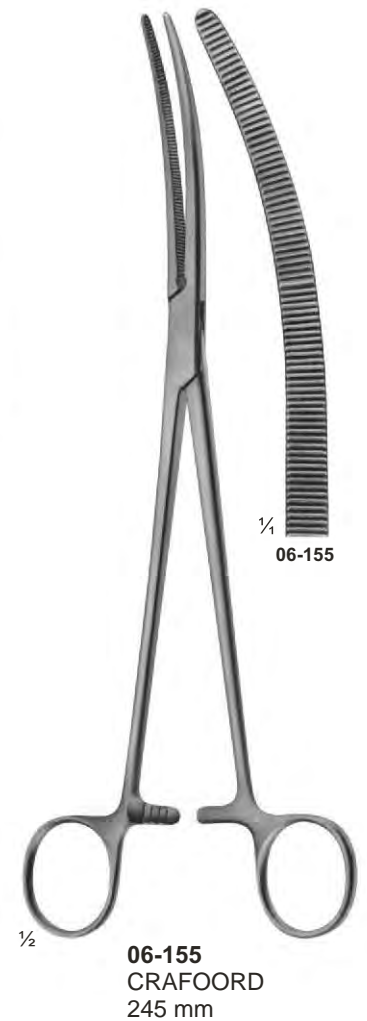
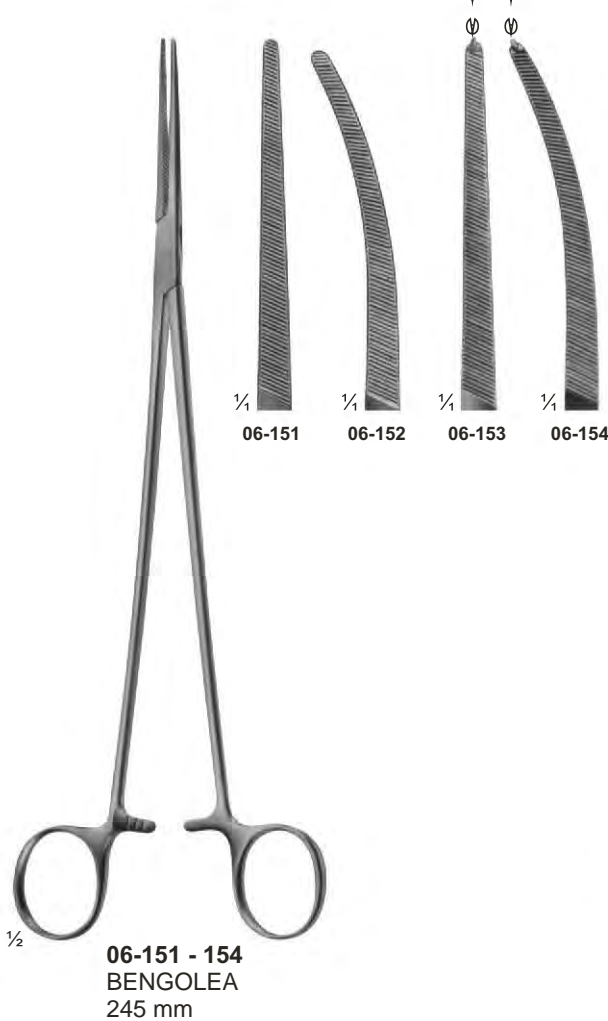
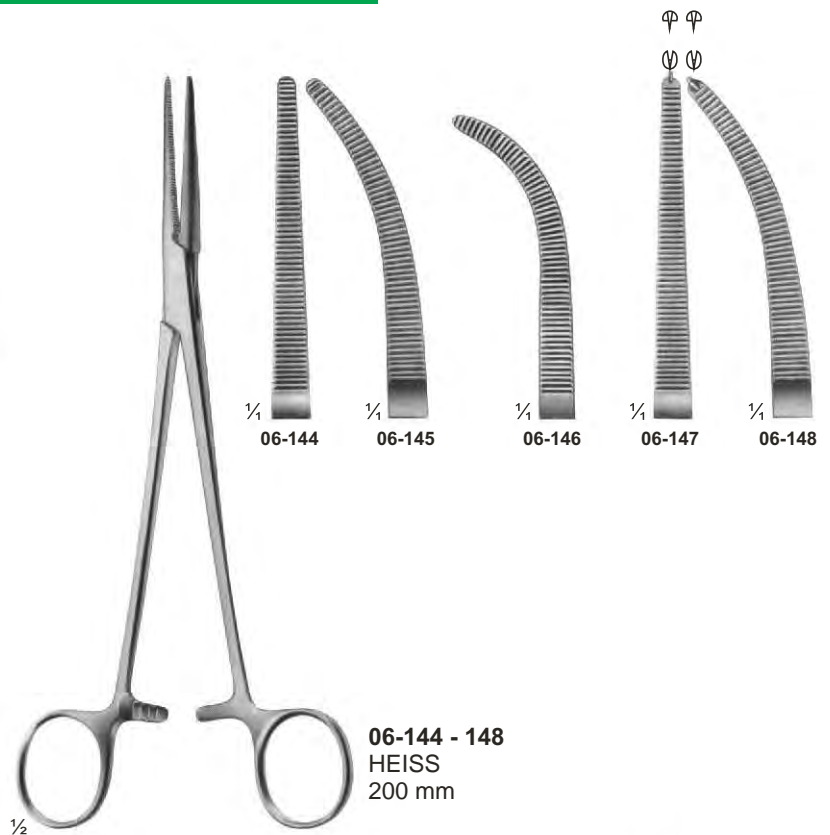
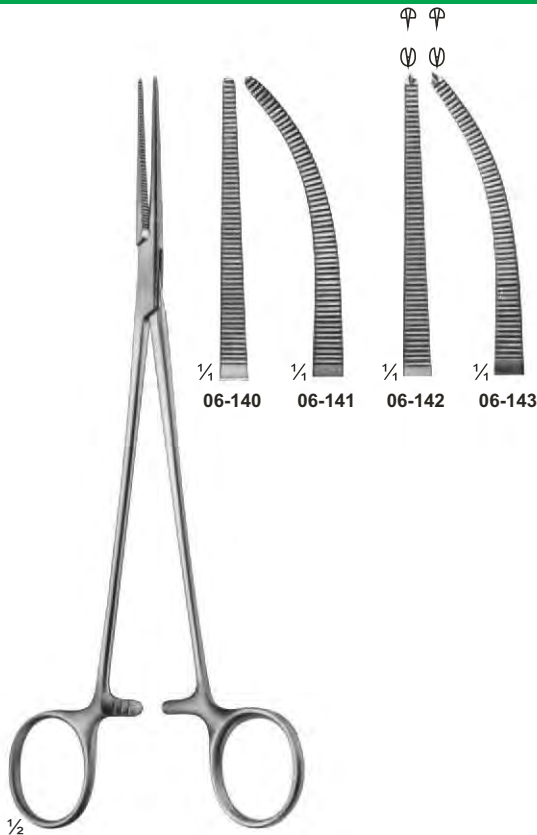

Haemostatic Forceps

REALSTAR SURGICAL INSTRUMENTS

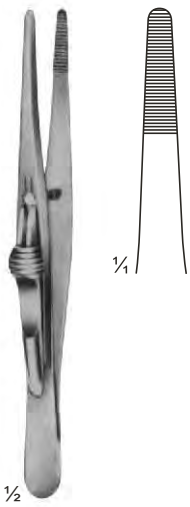

06-156
FRICKE
Artery forceps
130 mm

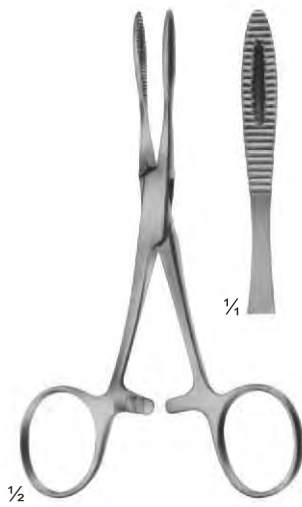

06-157
KRONLEIN
130 mm

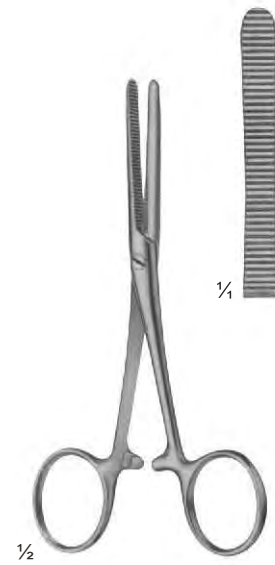

06-158
PEAN
125 mm

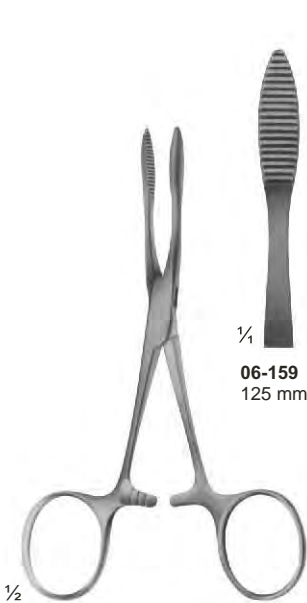

06-159 - 160
PEAN



06-160
140 mm

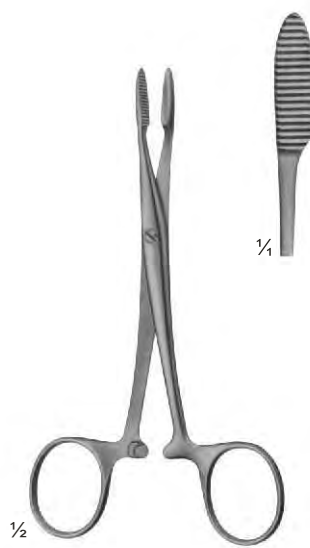

06-161
PEAN

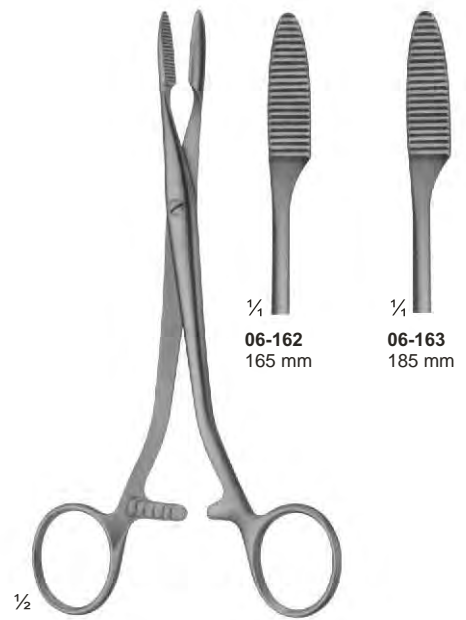

06-162 - 163
PEAN

06-162
165 mm

06-163
185 mm

Haemostatic Forceps

REALSTAR SURGICAL INSTRUMENTS

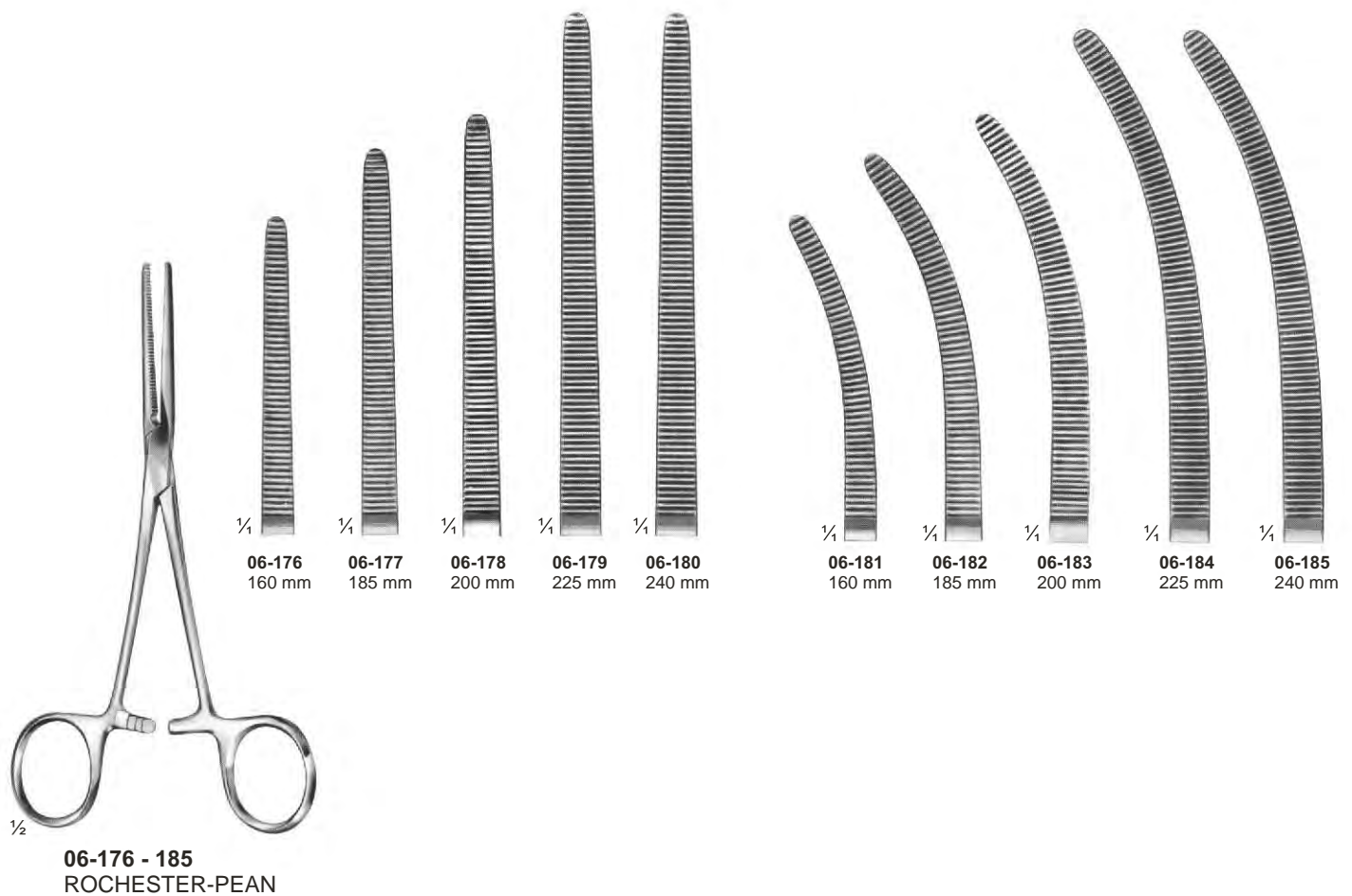
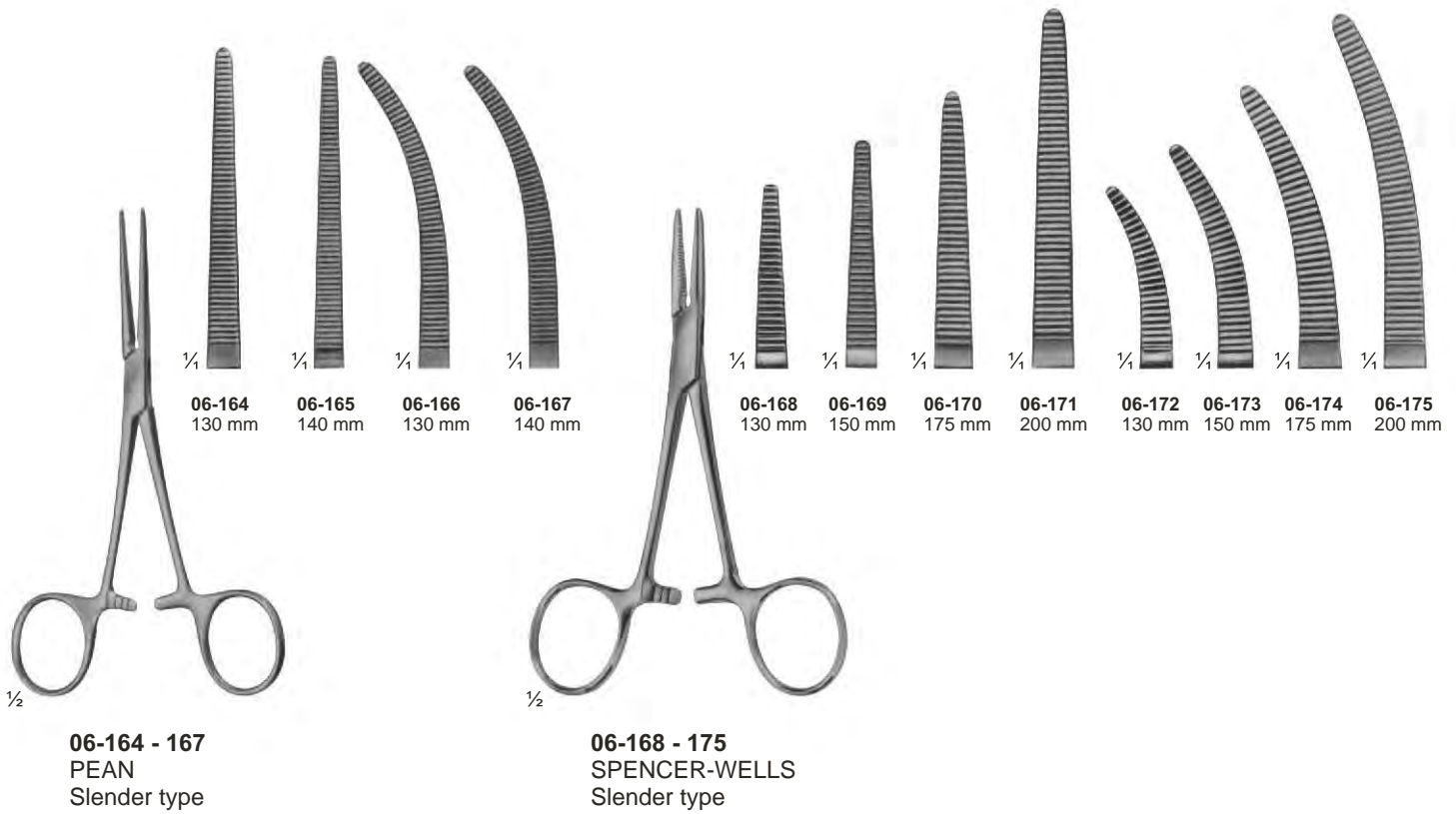

Haemostatic Forceps

REALSTAR SURGICAL INSTRUMENTS



06-186 - 191
PEAN

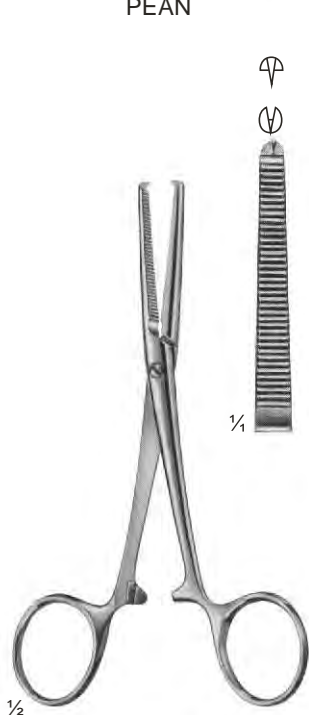
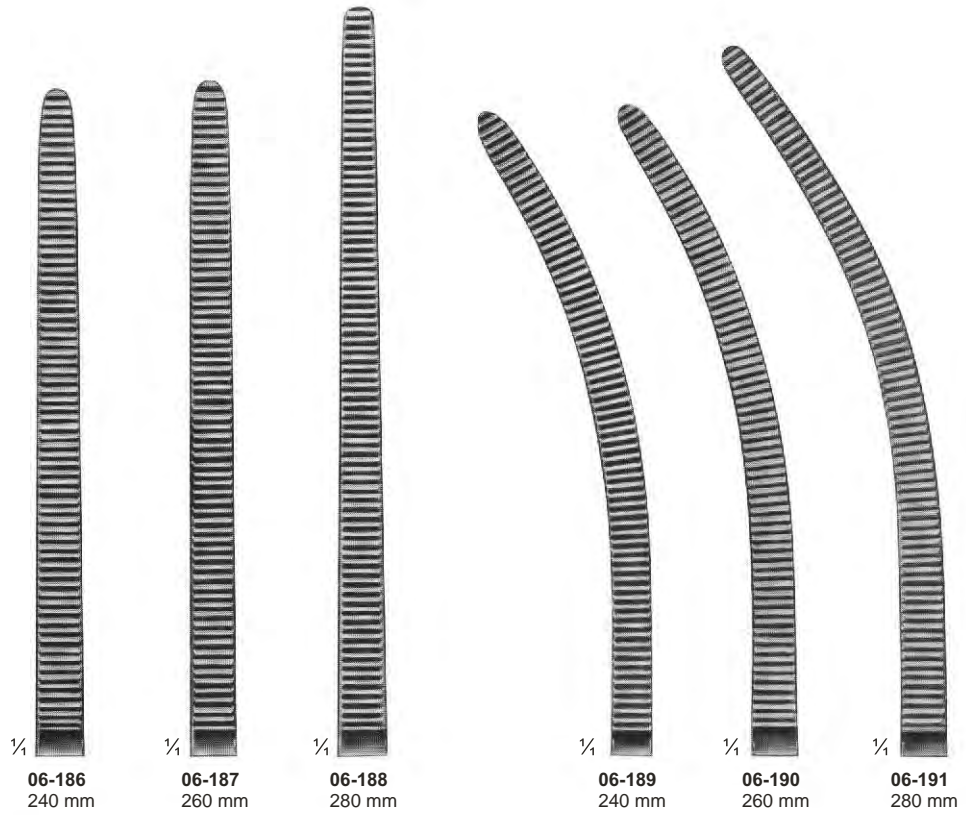

06-192
KOCHER
Strong Pattern
145 mm

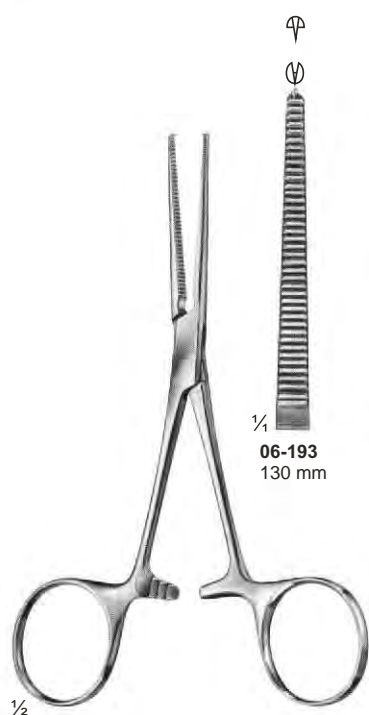

06-193 - 195
KOCHER

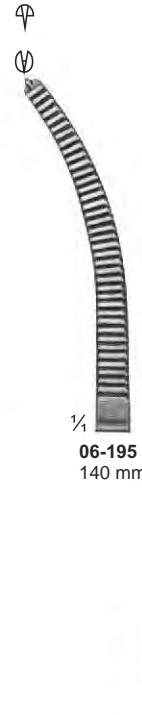

06-196 - 197
ROCHESTER-OGHSNER
140 mm



Haemostatic Forceps

REALSTAR SURGICAL INSTRUMENTS

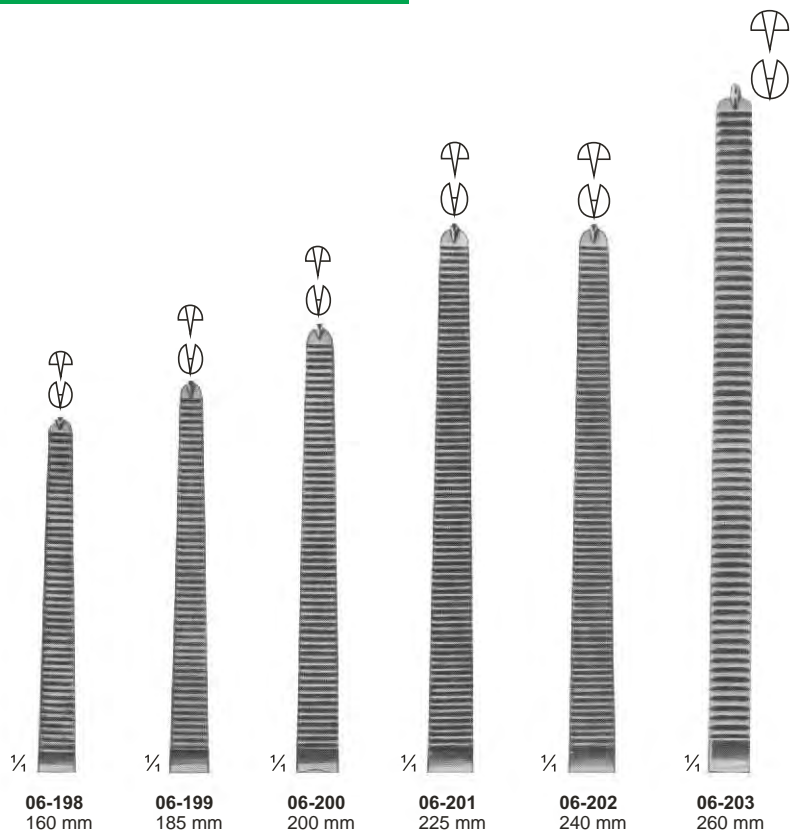

06-198 - 209
KOCHER-OCHSNER

Haemostatic Forceps, Special Pattern, Tonsil Forceps

REALSTAR SURGICAL INSTRUMENTS

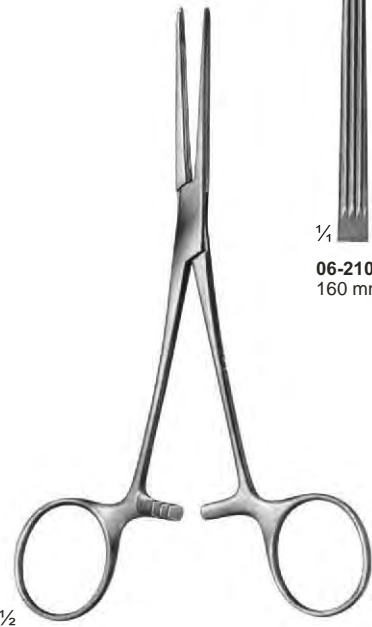

06-210 - 213
ROCHESTER-CARMALT

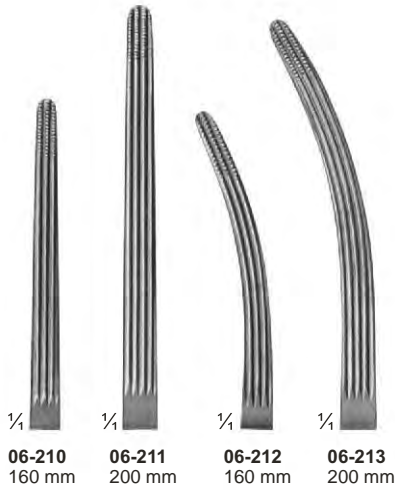

06-214 - 215
MOYNIHAN

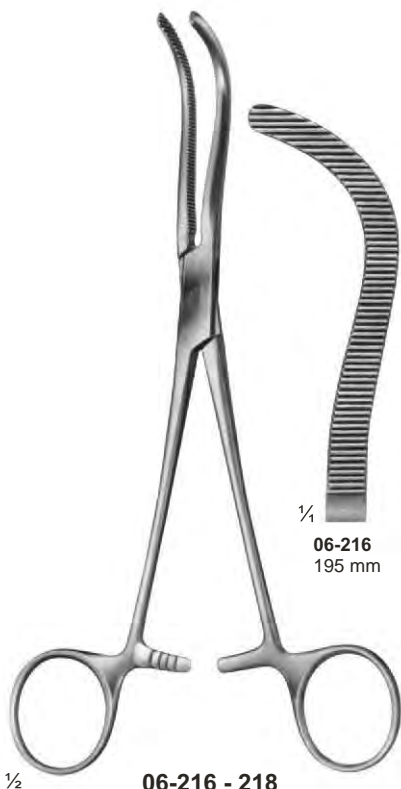

06-216 - 218
PEAN

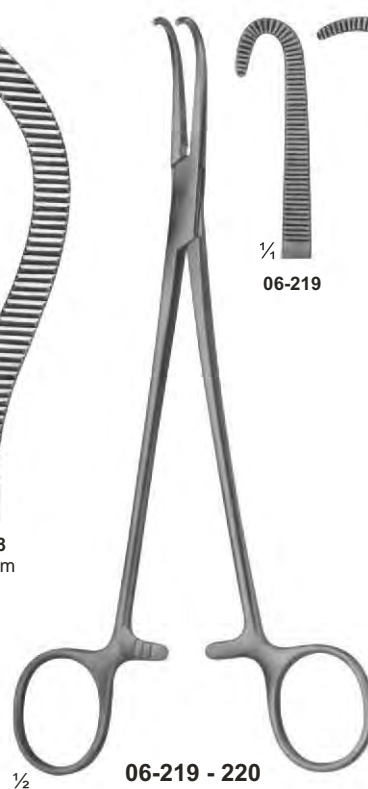

06-219 - 220
NEGUS
190 mm

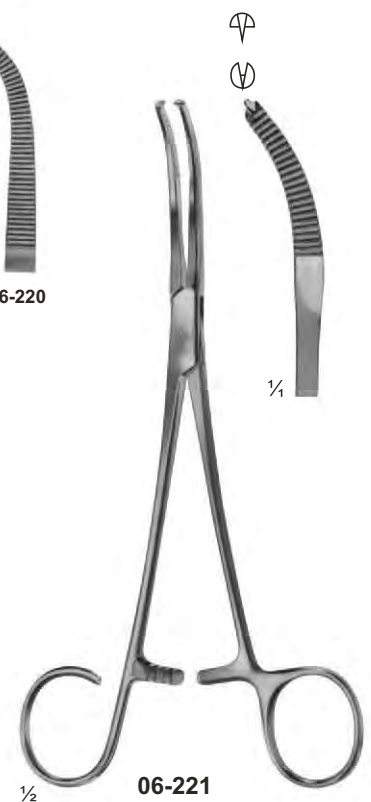
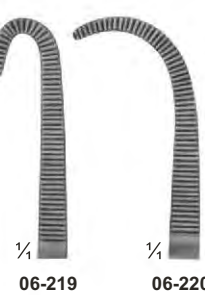

06-221
MIKULICZ
185 mm



Dissecting- and Ligature Forceps

REALSTAR SURGICAL INSTRUMENTS

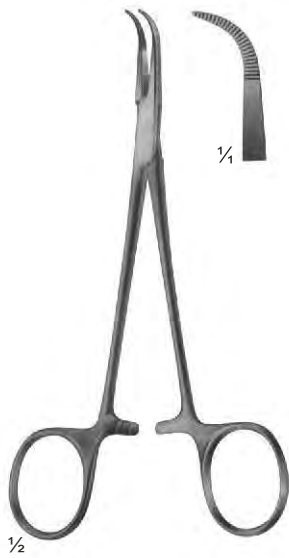

06-222
MICRO-ADSON
140 mm



06-223
BABY-OVERHOLT
135 mm



06-224 - 225
BABY-MIXTER

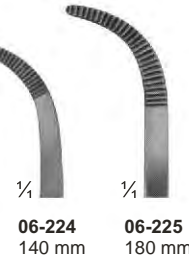

06-224
140 mm

06-225
180 mm



06-226 - 227
BABY-ADSON

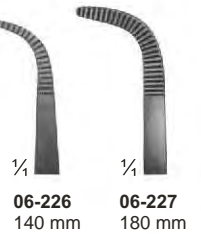

06-226
140 mm

06-227
180 mm



06-228
NISSEN



06-228
185 mm



06-229 - 230
YASARGIL
195 mm



06-229



06-230

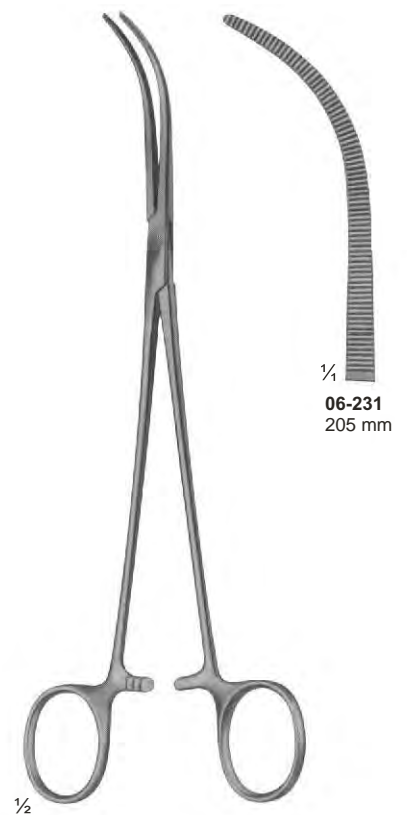

06-231
OVERHOLT-MIXTER



06-231
205 mm

Dissecting- and Ligature Forceps

REALSTAR SURGICAL INSTRUMENTS

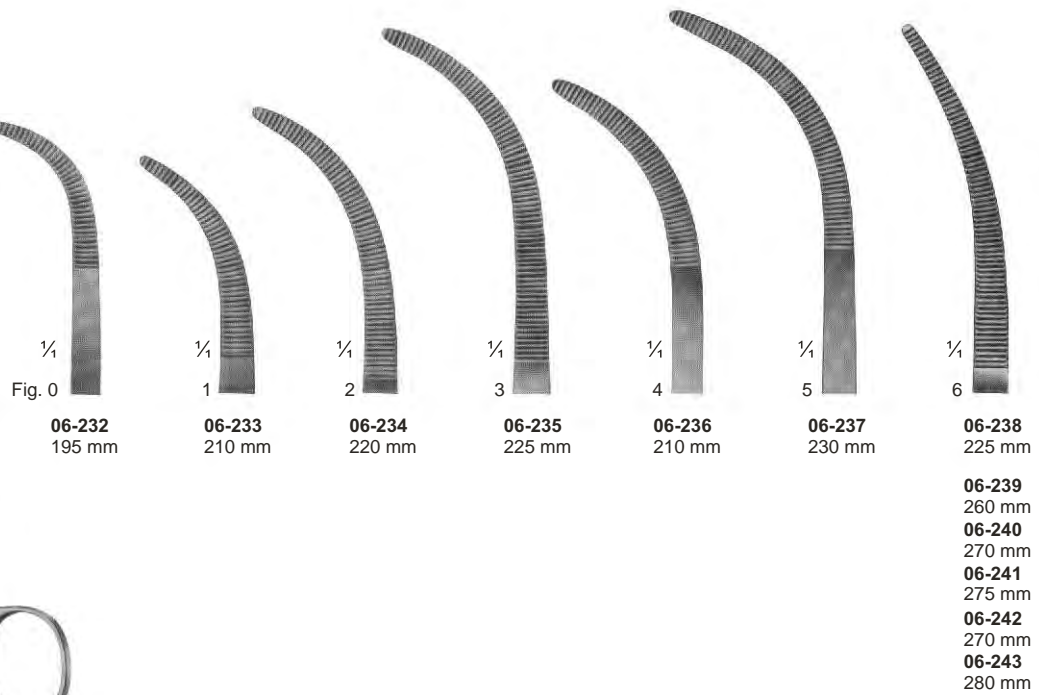

06-232 - 243
OVERHOLT-GEISSENDOERFER

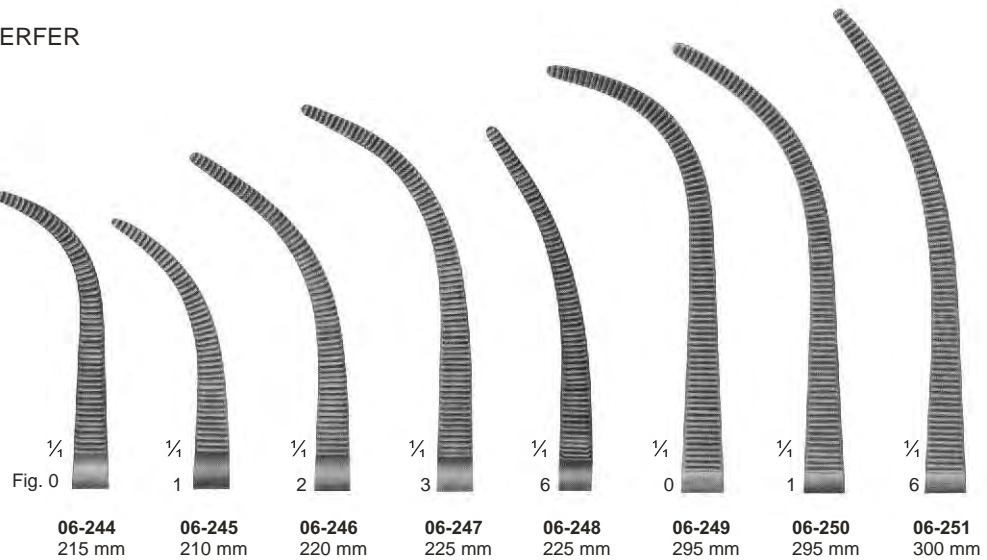
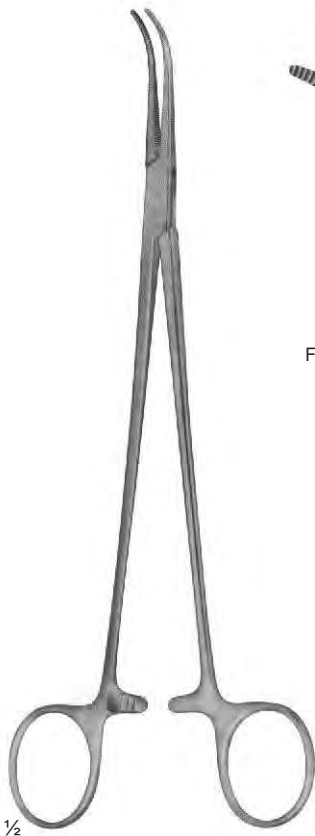

06-244 - 251
OVERHOLT
fine pattern

Dissecting- and Ligature Forceps

REALSTAR SURGICAL INSTRUMENTS



06-252
MIXTER-O'SHAUGNESSY
190 mm

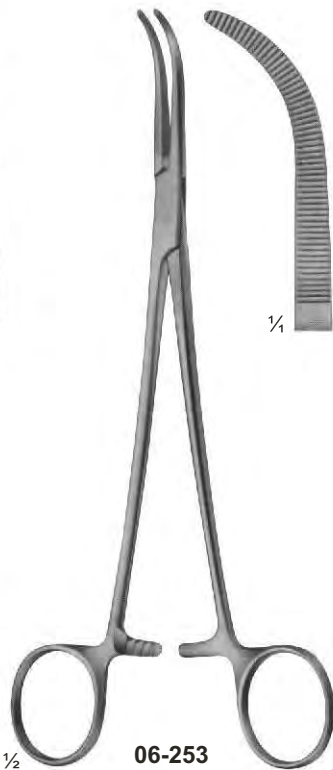

06-253
HEISS
195 mm

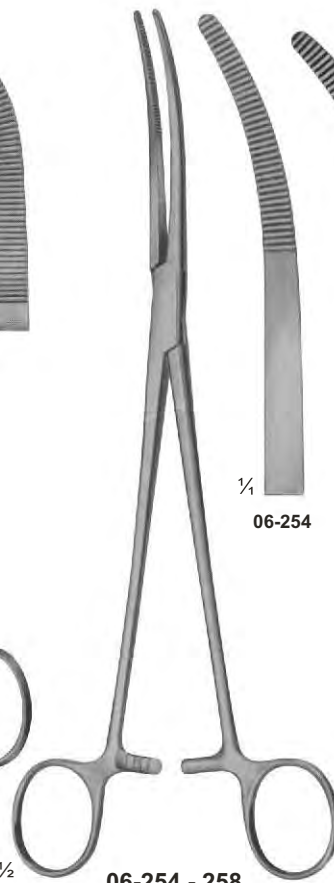

06-254 - 258
RUMEL
240 mm

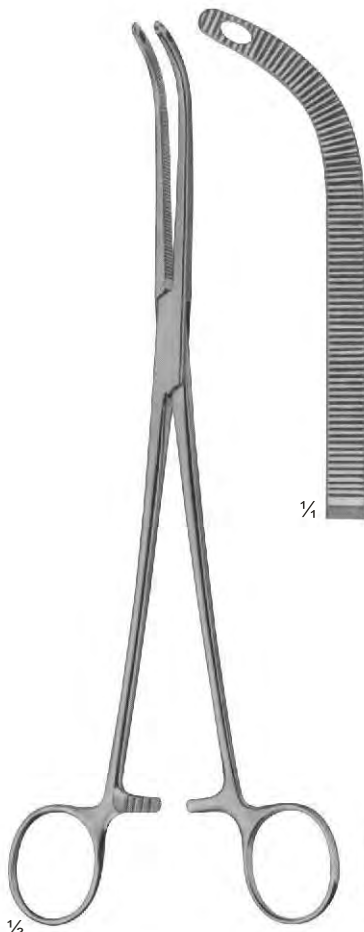
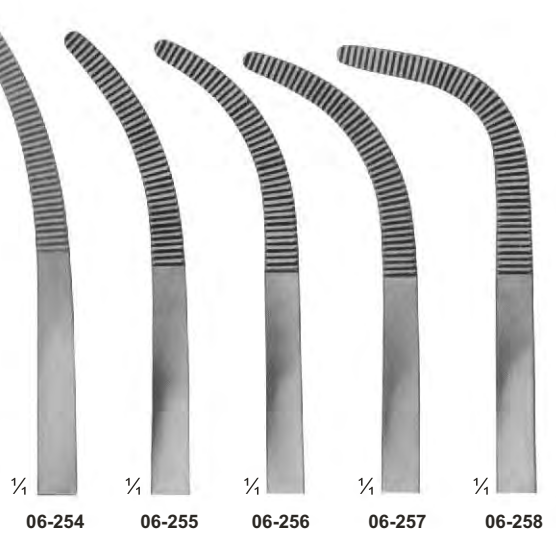

06-259
FINOCHIETTO
245 mm

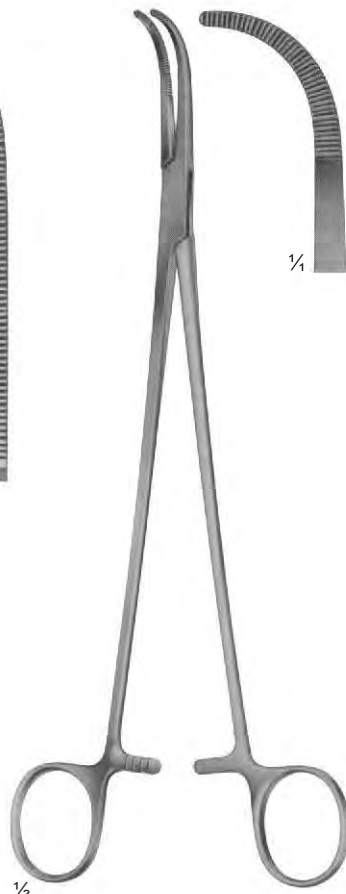

06-260
MIXTER
230 mm



06-261
LAWRENCE
270 mm

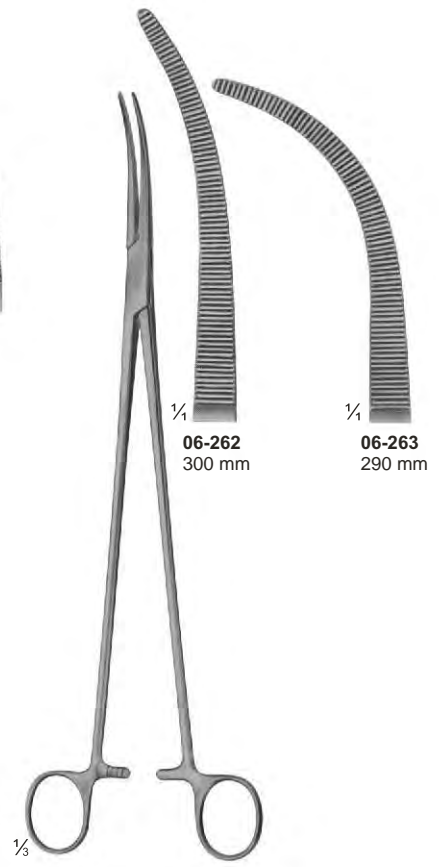

06-262 - 263
ZENKER
300 mm
290 mm

Dissecting- and Ligature Forceps

REALSTAR SURGICAL INSTRUMENTS

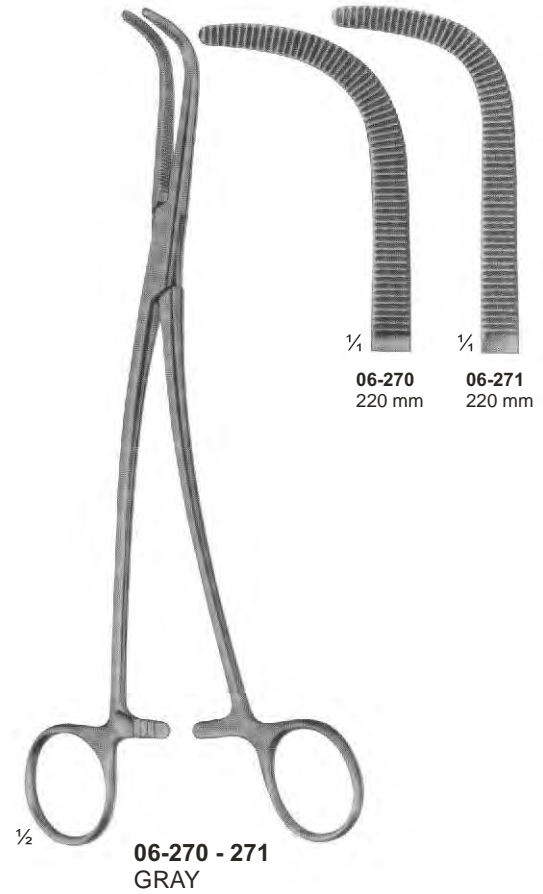
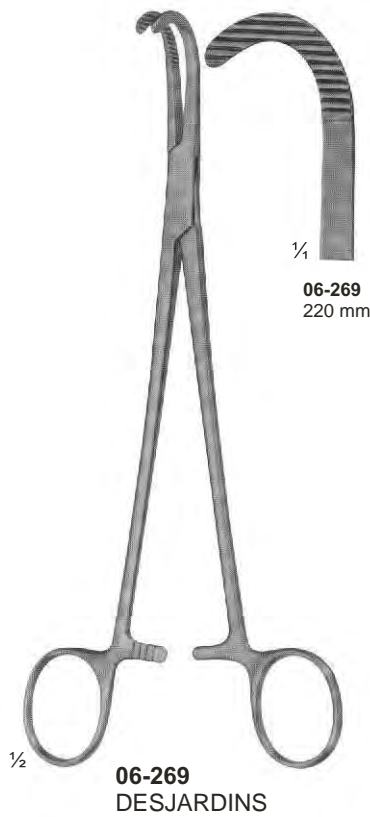

Peritoneum Forceps

REALSTAR SURGICAL INSTRUMENTS

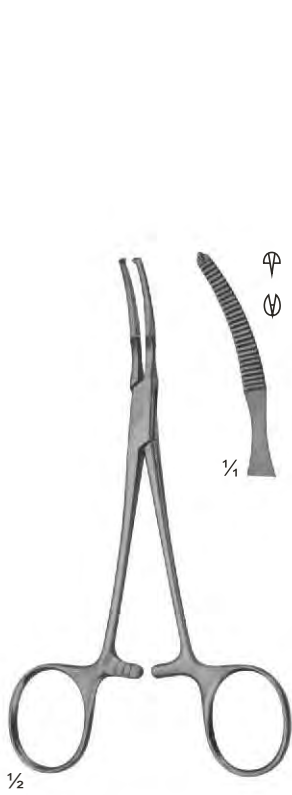

06-272
BABY-MIKULICZ
140 mm

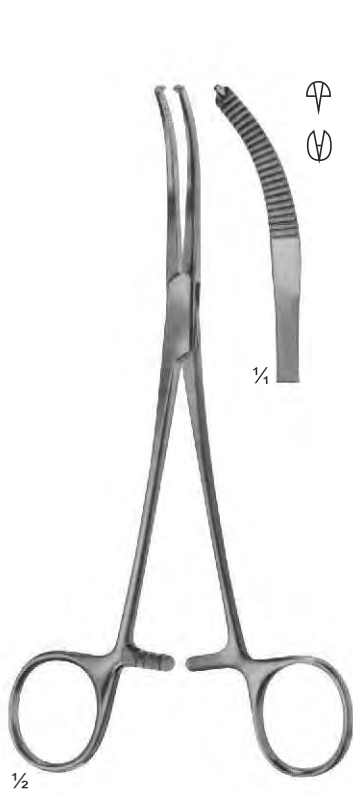

06-273
MIKULICZ
185 mm

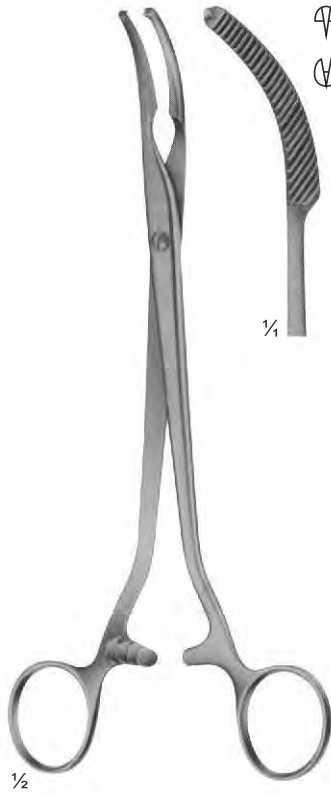

06-274
MIKULICZ
205 mm

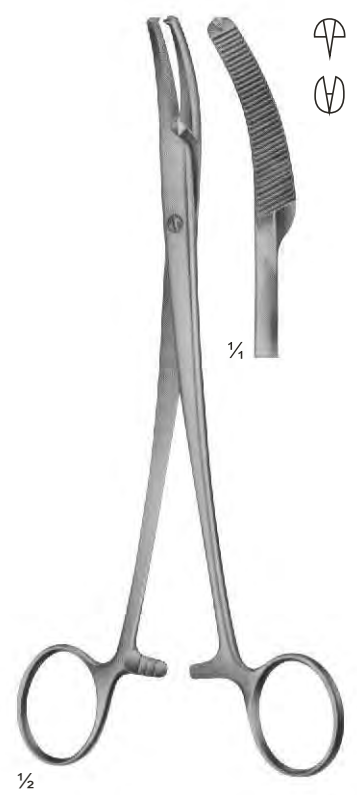

06-275
MIKULICZ
200 mm

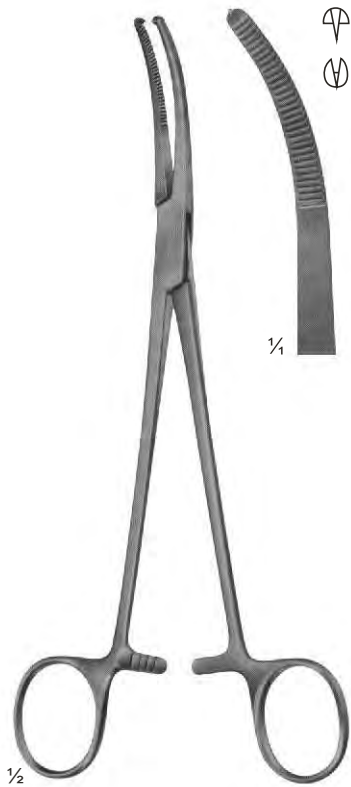

06-276
MIKULICZ
205 mm

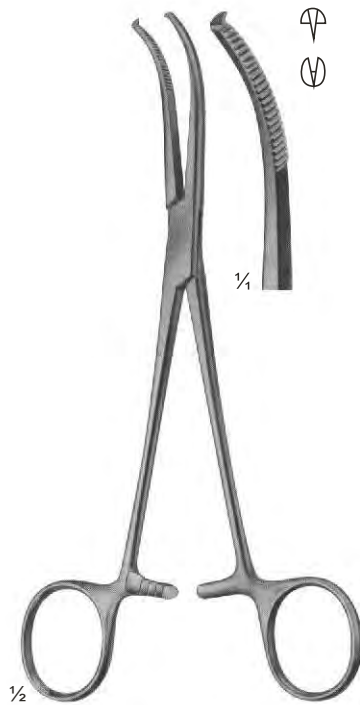

06-277
MIKULICZ
185 mm

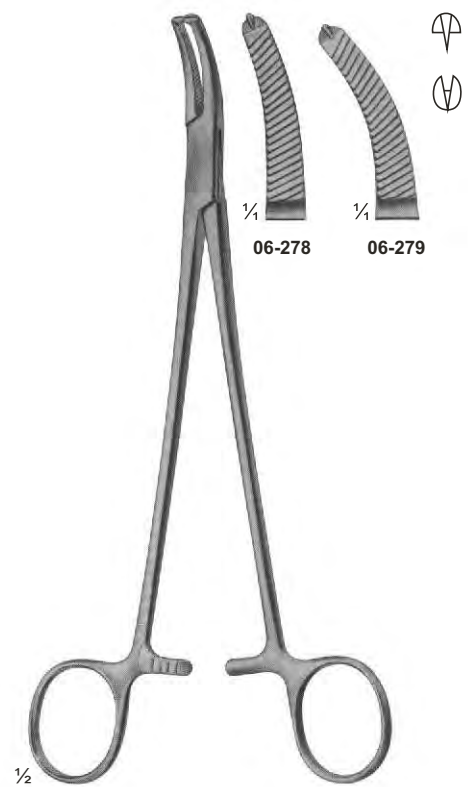

06-278 - 279
FAURE
205 mm

Hysterectomy Forceps

REALSTAR SURGICAL INSTRUMENTS

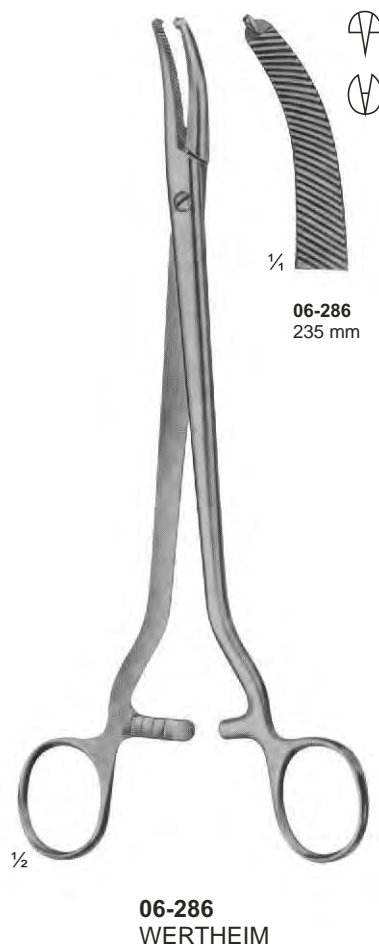
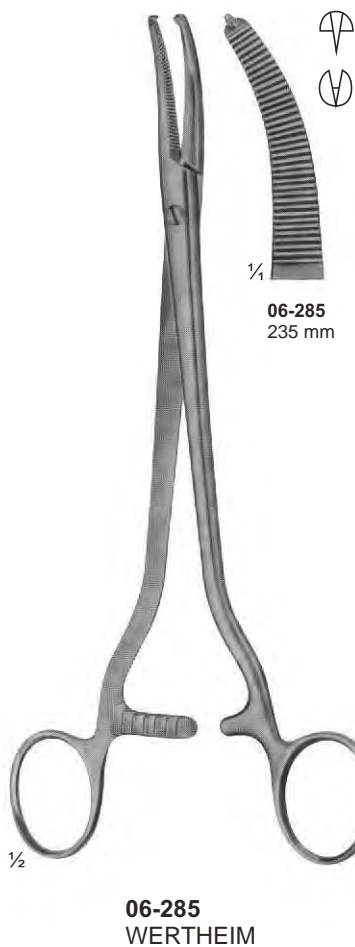
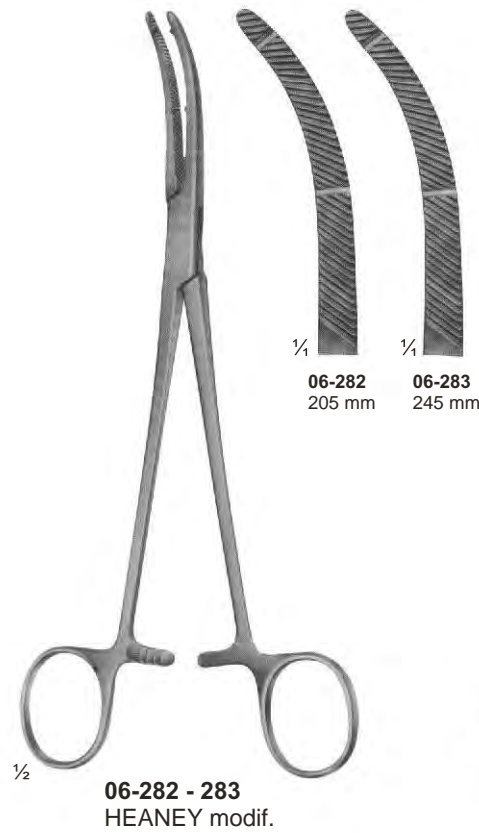
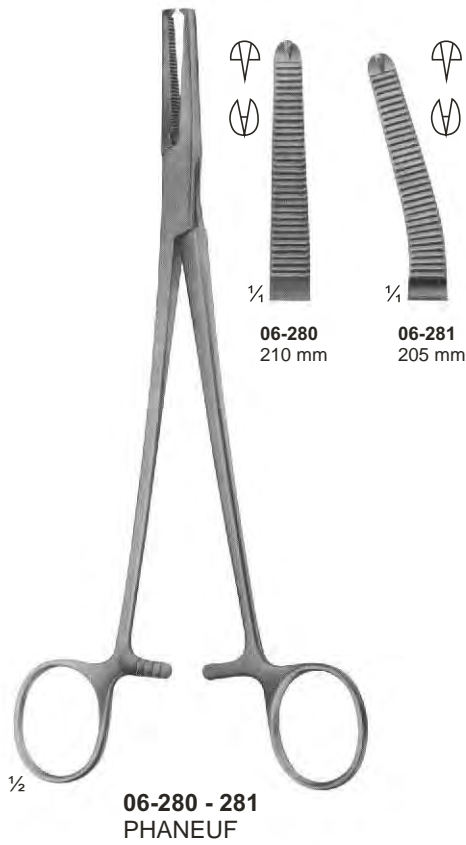

Hysterectomy Forceps and Vaginal Clamps

REALSTAR SURGICAL INSTRUMENTS



06-288
225 mm



06-289
220 mm



06-290
215 mm

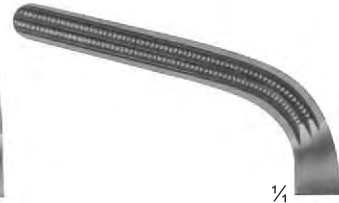

06-291
205 mm



06-292
250 mm



06-293
245 mm



06-294
240 mm

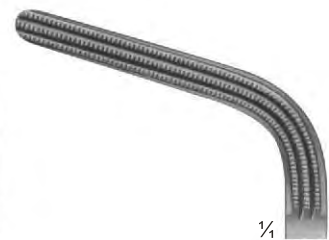

06-295
220 mm

Hysterectomy Forceps and Vaginal Clamps and Compression Forceps

REALSTAR SURGICAL INSTRUMENTS

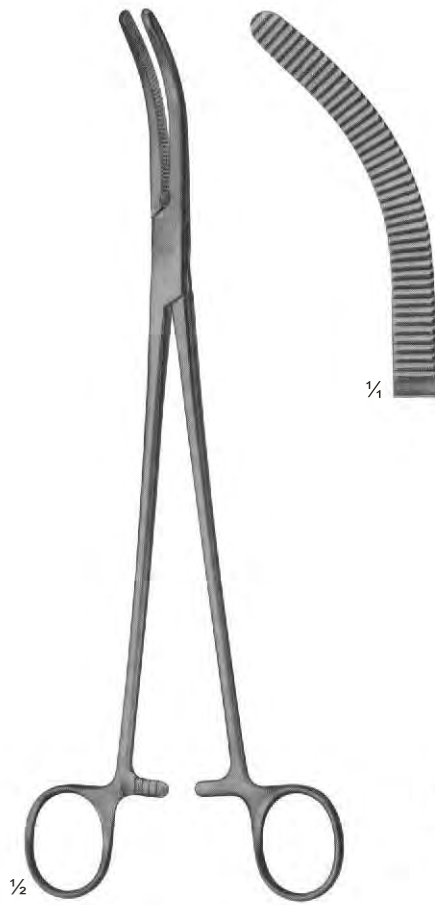

06-296
WERTHEIM
Hysterectomy Forceps
255 mm

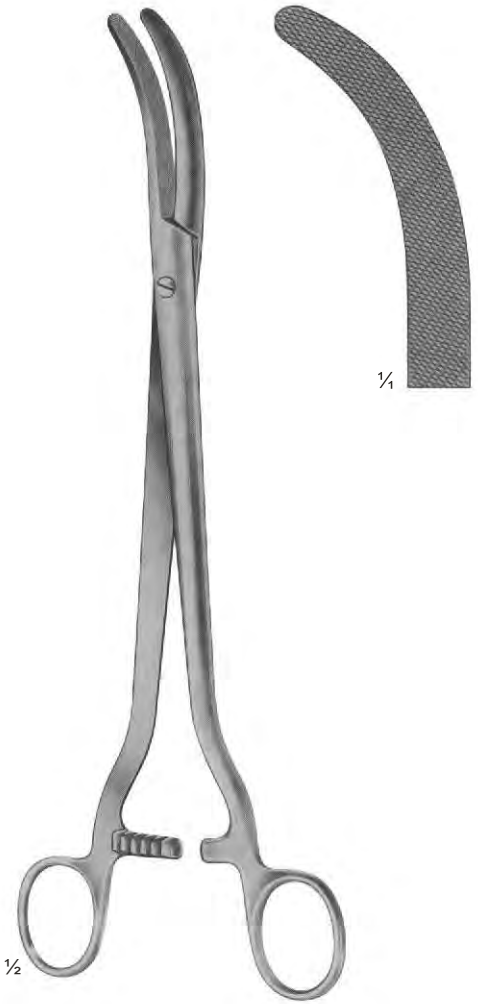

06-297
WERTHEIM
Parametrium Clamp
260 mm

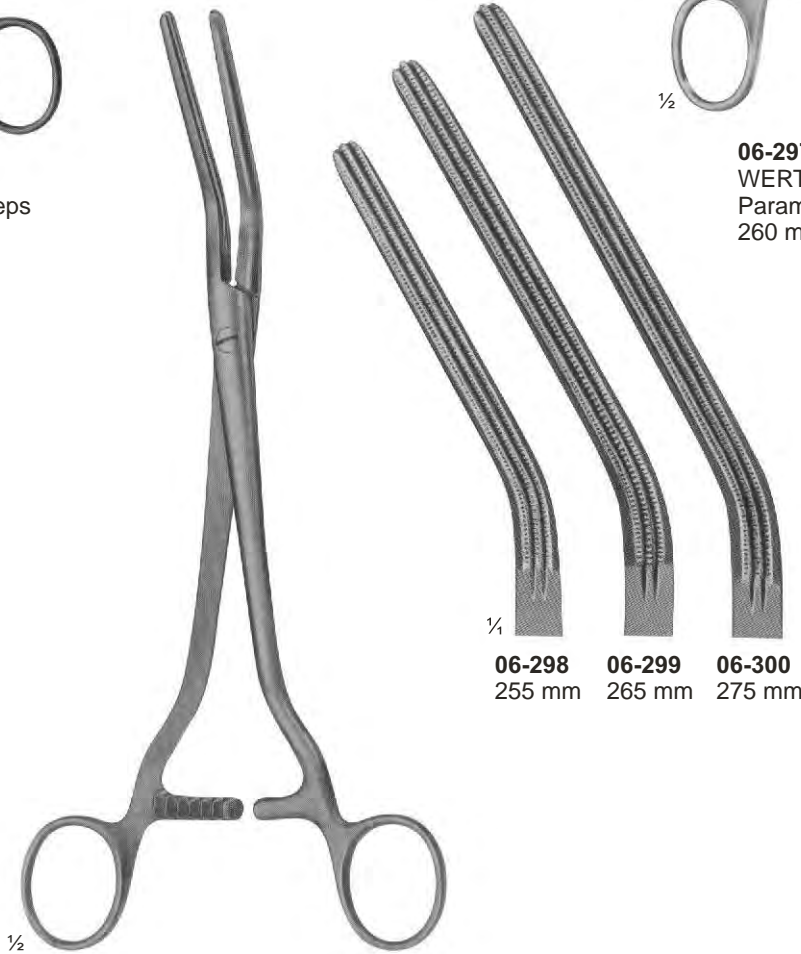

06-298 - 300
DICK

06-298 255 mm
06-299 265 mm
06-300 275 mm

Hysterectomy Forceps and Vaginal Clamps and Compression Forceps

REALSTAR SURGICAL INSTRUMENTS

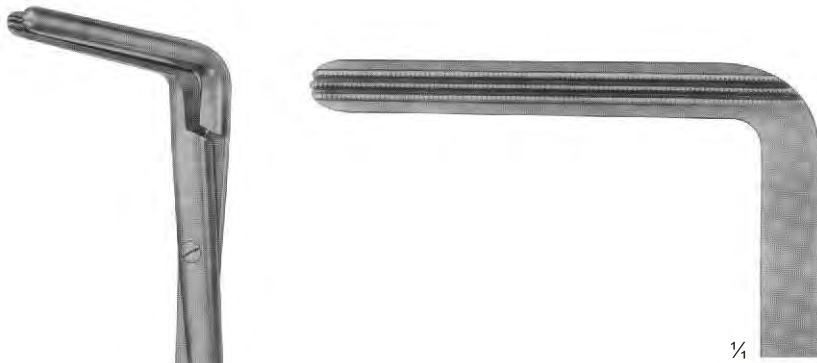

06-301
WERTHEIM
250 mm

1/2

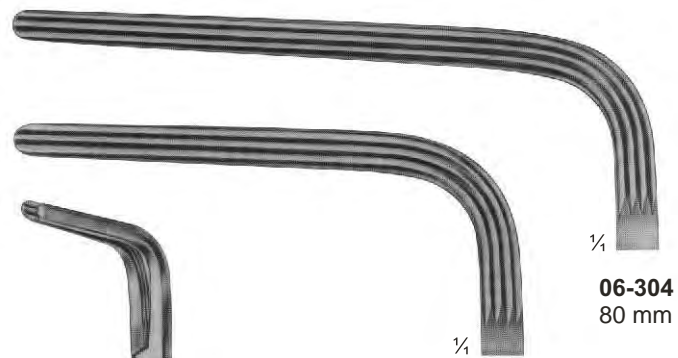

06-304
80 mm

1/4

06-303
60 mm

1/4



1/2

06-303 - 304
230 mm



1/2

06-302
WERTHEIM-CULLEN
215 mm

Needle Holders For Micro Surgery

REALSTAR SURGICAL INSTRUMENTS



07-101
ROHRSCHEIDER
With copper inserts
100 mm



07-102
KALT
With catch
135 mm



07-103
ARRUGA
With catch
135 mm



07-104 - 105
CASTROVIEJO
With catch
145 mm



07-106 - 107
CASTROVIEJO
With Catch
160 mm



07-108 - 109
Without catch
185 mm

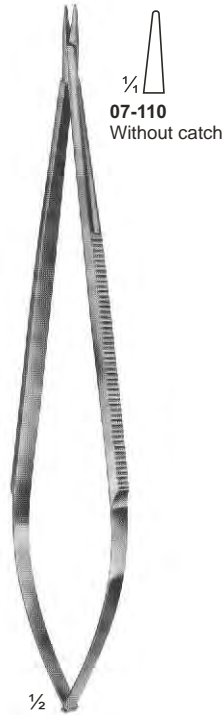

07-110 - 111
JACOBSON
185 mm



07-112
Without catch
195 mm



07-113 - 114
YASARGIL
With catch
200 mm

Micro Needle Holders With Round Handles

REALSTAR SURGICAL INSTRUMENTS

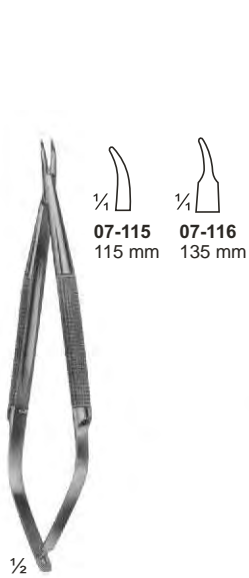

07-115 116
BARRAQUER
Without catch



07-117 - 118
BARRAQUER
Without catch
120 mm



07-119 - 120
BARRAQUER
With catch
120 mm



07-121 - 122
BARRAQUER
With Catch
150 mm



07-123
MULLER
With Locking
Mechanism
145 mm



07-124 - 125
BROCK
Without catch
150 mm



07-126 - 127
YASARGIL
200 mm



07-128 - 129
YASARGIL
225 mm



07-130
YASARGIL
245 mm

Needle Holders

REALSTAR SURGICAL INSTRUMENTS



1/2 **07-131**
CONVERSE
125 mm



1/2 **07-132**
WEBSTER
125 mm



Smooth jaws

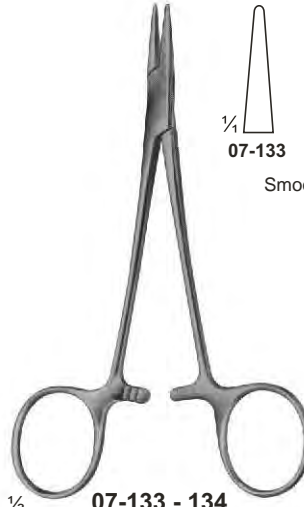

1/2 **07-133 - 134**
HALSEY
130 mm



07-133



07-134

Smooth jaws



1/2 **07-135**
DERF
130 mm

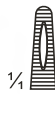

1/2 **07-136**
DOYEN
125 mm



1/2 **07-137**
BAUMGARTNER
145 mm

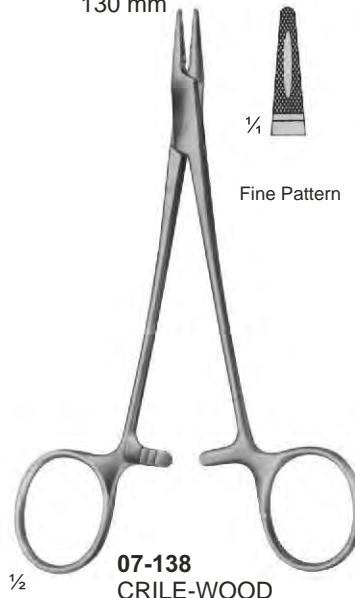

1/2 **07-138**
CRILE-WOOD
150 mm



Fine Pattern



1/2 **07-139**
CRILE-WOOD
160 mm



1/2 **07-140**
CRILE-MURRAY
150 mm

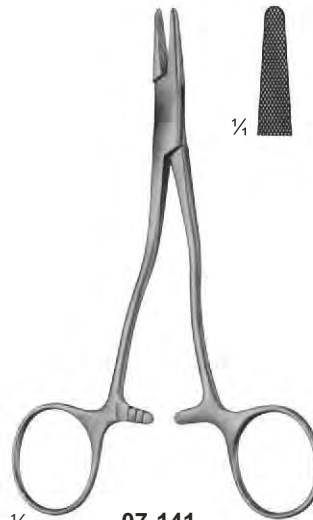

1/2 **07-141**
KILNER
135 mm



1/2 **07-142**
ADSON
175 mm



Needle Holders

REALSTAR SURGICAL INSTRUMENTS

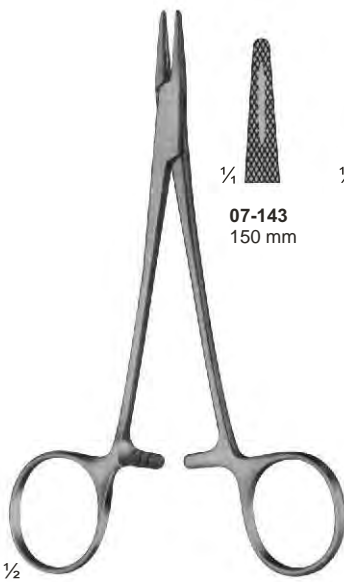

07-143
150 mm

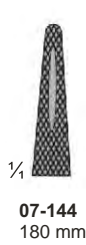

07-144
180 mm

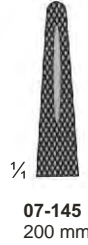

07-145
200 mm

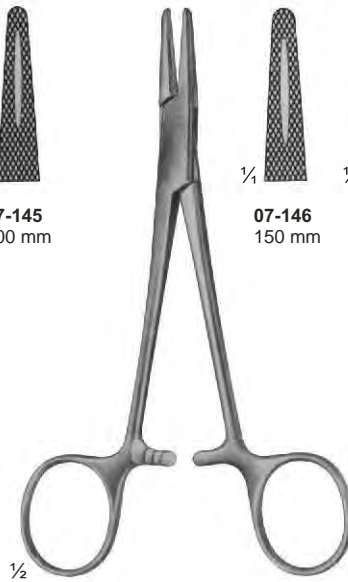

07-146
150 mm



07-147
175 mm



07-148
200 mm



07-149
205 mm



07-150
HEANEY (HEGAR)
200 mm



07-151
JAMESON
230 mm



07-152
WANGENSTEEN
275 mm



07-153
MASSON
265 mm

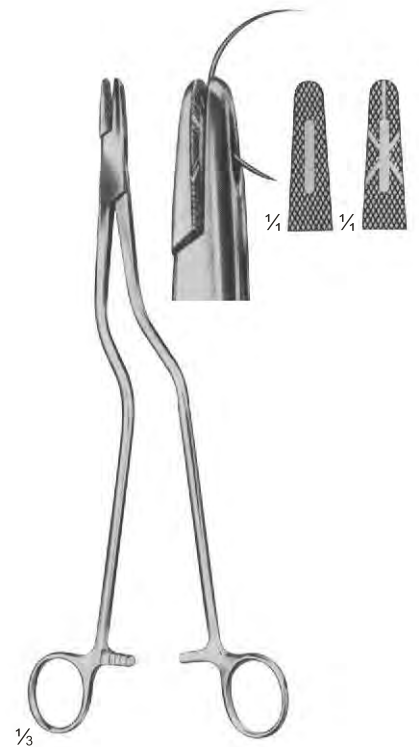

07-154
MASSON-LUETHY
255 mm

Needle Holders

REALSTAR SURGICAL INSTRUMENTS

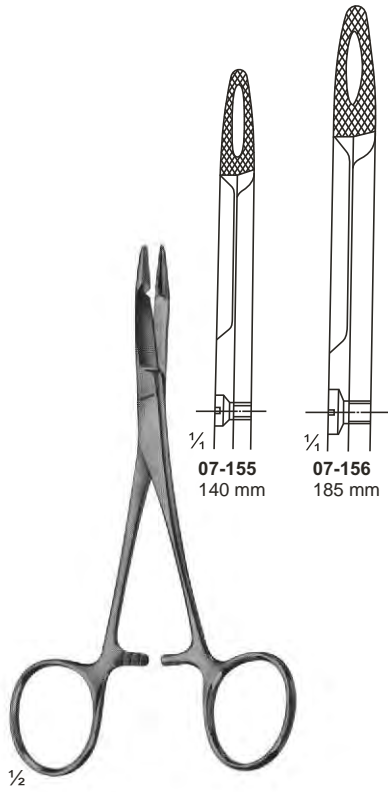

07-155 - 156
HEGAR-OLSEN
255 mm

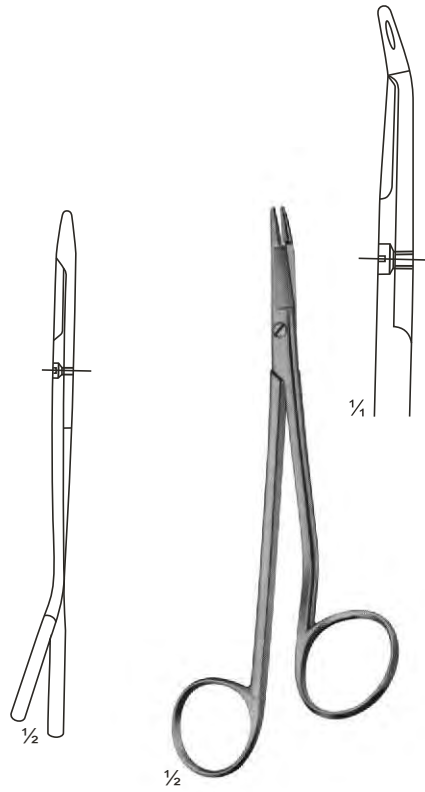

07-157
GILLIES
150 mm

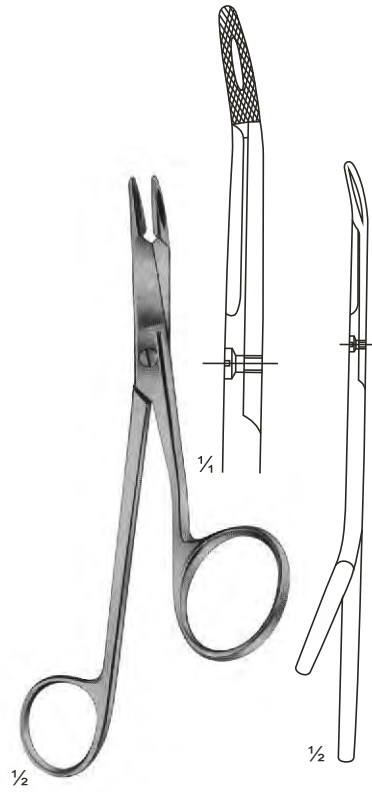

07-158
GILLIES
160 mm

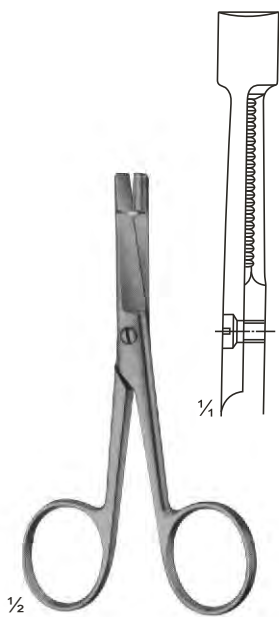

07-159
EISELSBERG
115 mm

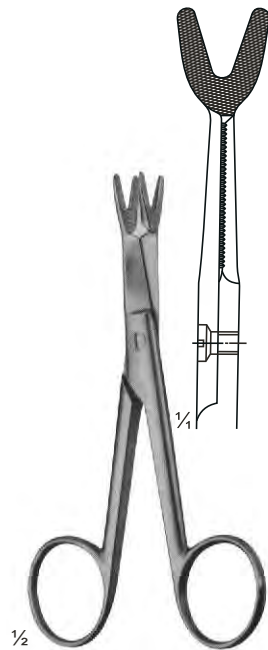

07-160
SCHOEMAKER-LOTH
125 mm



07-161
CRILE
150 mm



07-162
TONNIS
Elastic pattern for
dura-or intestinal suture
180 mm

Needle Holders

REALSTAR SURGICAL INSTRUMENTS

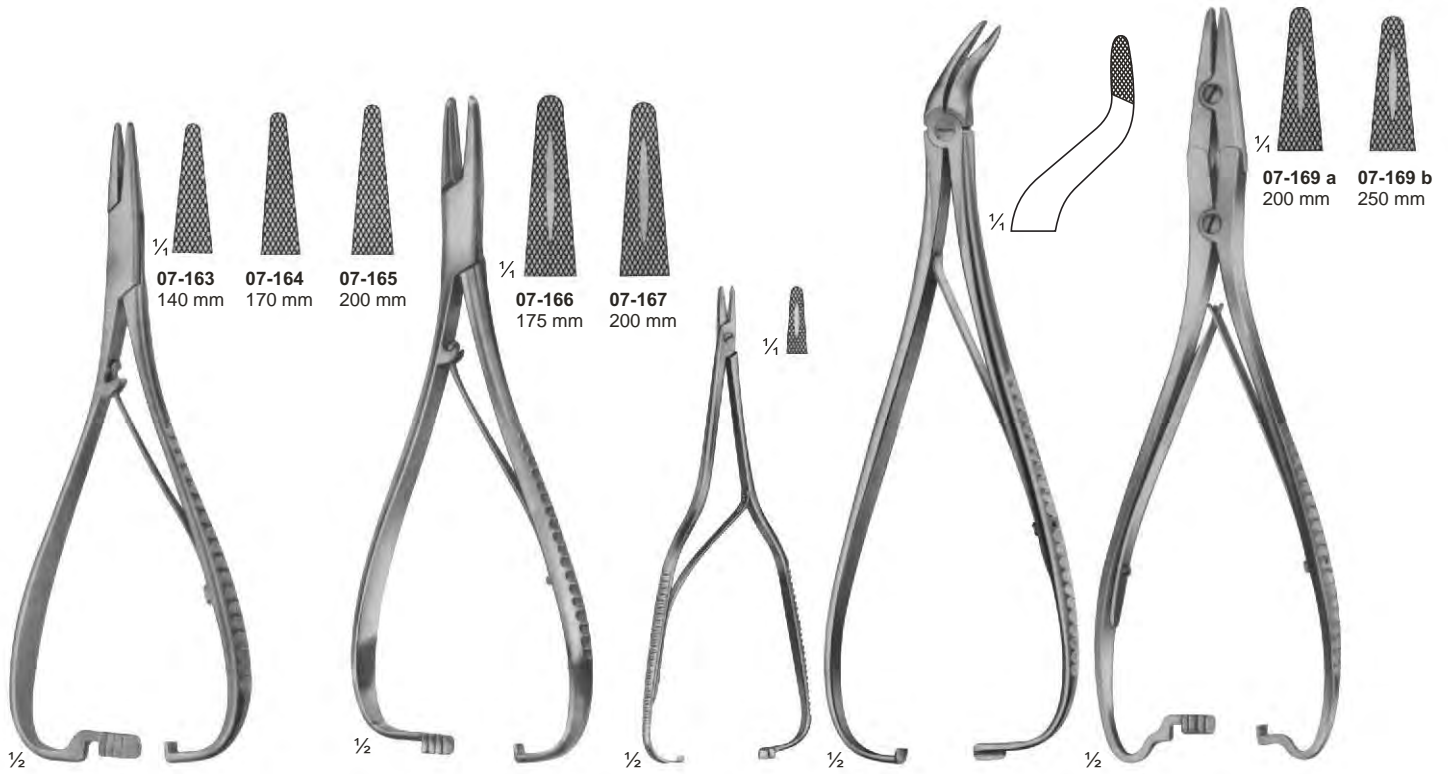

07-163
140 mm

07-164
170 mm

07-165
200 mm

07-166
175 mm

07-167
200 mm

07-169 a
200 mm

07-169 b
250 mm

07-163 - 165
MATHIEU

07-166 - 167
MATHIEU-STILLE
Very heavy models

07-168
BOYNTON
125 mm

07-169
EISELSBERG-MATHIEU
For palate suture
195 mm

07-169 a - 169 b



07-170

07-171

07-172



07-173 1/2
YOUNG-HRYNTSCHAK
With 1 needle
240 mm

07-174 1/2
YOUNG-MILLIN
With 1 needle
200 mm



07-175
MILLIN
Ligature holding forceps
245 mm

Suture Instruments - Reverdin Needles

**REALSTAR SURGICAL
INSTRUMENTS**

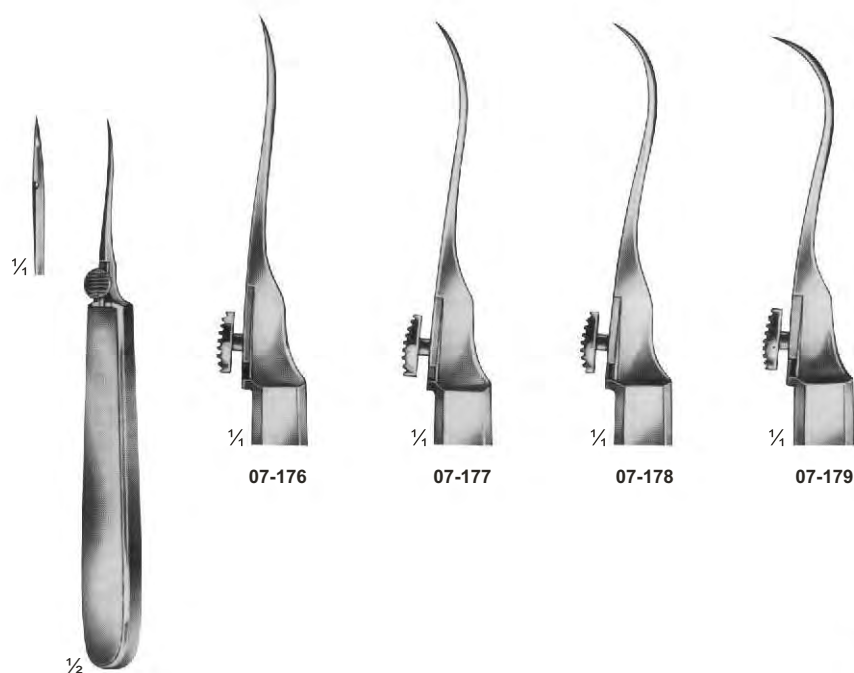

**07-176 - 179
REVERDIN
140 mm**



**07-180 - 183
REVERDIN**

**07-184 - 188
REVERDIN
220 mm**

**REALSTAR SURGICAL
INSTRUMENTS**

SERVING TO SAVE LIVES

Suture Instruments - Ligature Needles

REALSTAR SURGICAL INSTRUMENTS

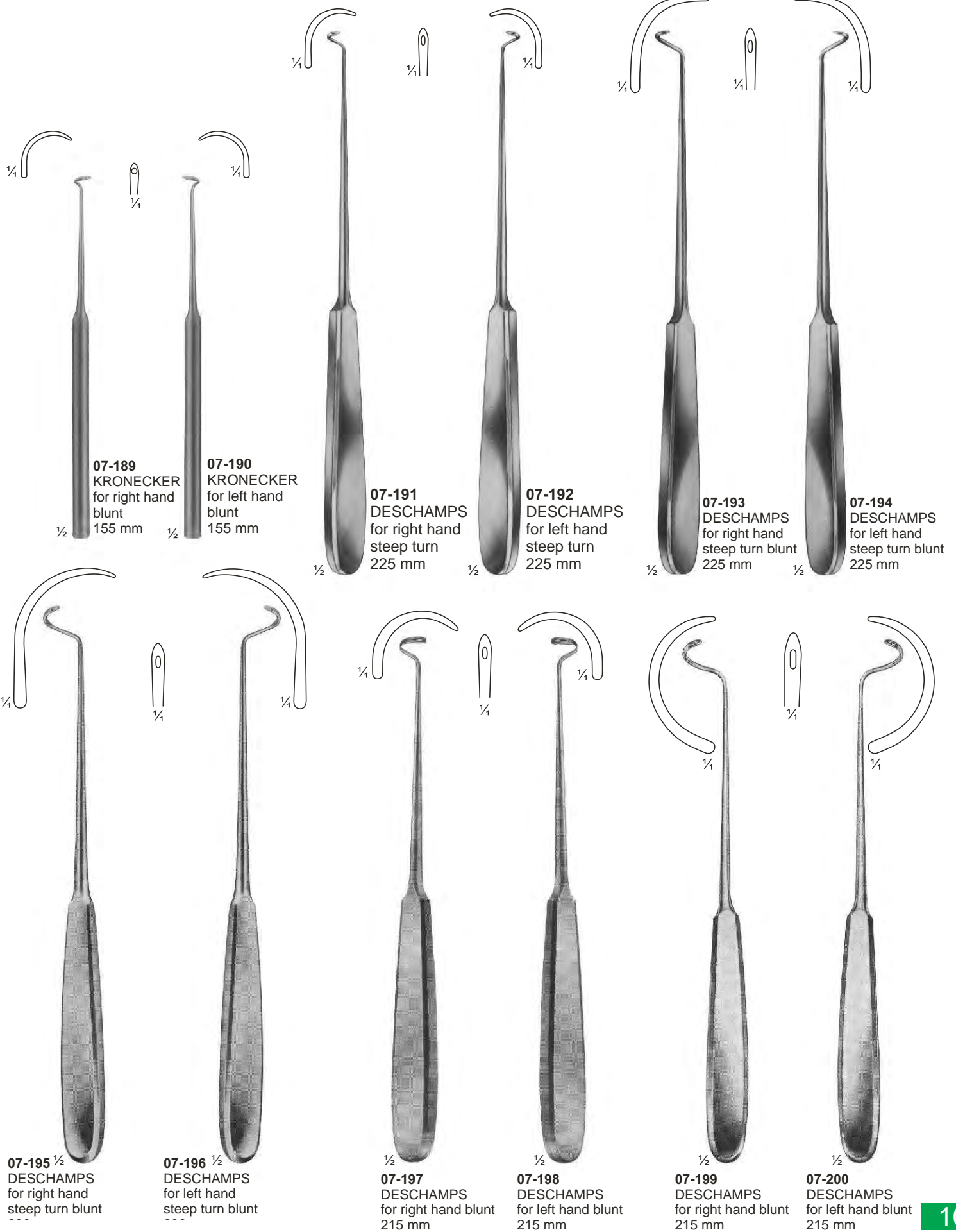

REALSTAR SURGICAL INSTRUMENTS

SERVING TO SAVE LIVES

Suture Instruments - Ligature Needles

REALSTAR SURGICAL INSTRUMENTS



1/2
07-201
HURD
for right hand
sharp
210 mm



1/2
07-202
HURD
for left hand
sharp
210 mm



1/2
07-203
DESCHAMPS
for right hand
sharp
215 mm



1/2
07-204
DESCHAMPS
for left hand
sharp
215 mm



1/2
07-205
JONESCO
Needle for wire suture
185 mm



1/2
07-206
CLAUS VAN EICKEN
Needle for wire suture
250 mm

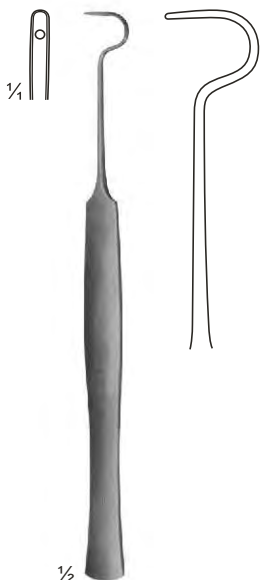

1/2
07-207
150 mm

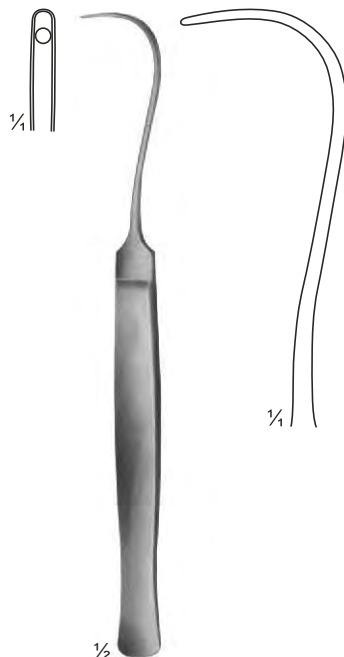

1/2
07-208
SYME
170 mm

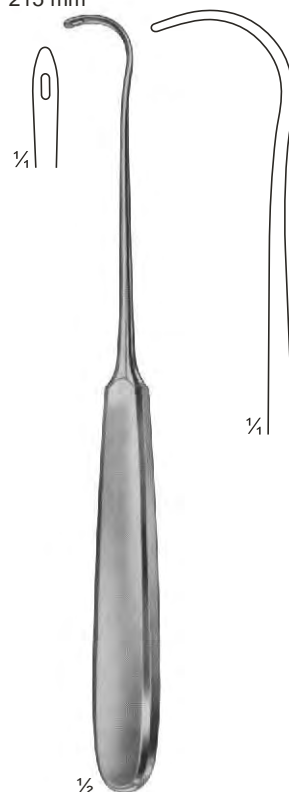

1/2
07-209
COOPER
205 mm

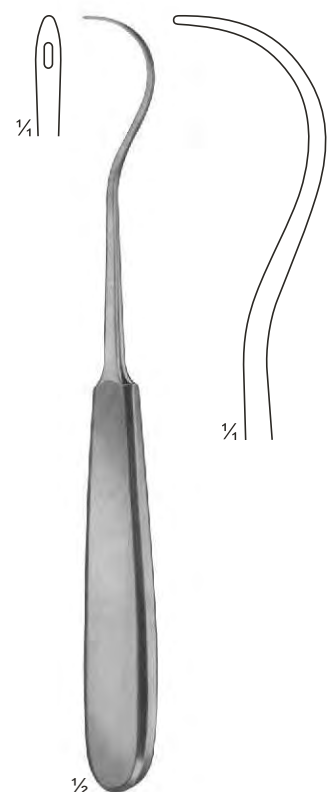

1/2
07-210
KOCHER
205 mm

Ligature Needles

REALSTAR SURGICAL INSTRUMENTS

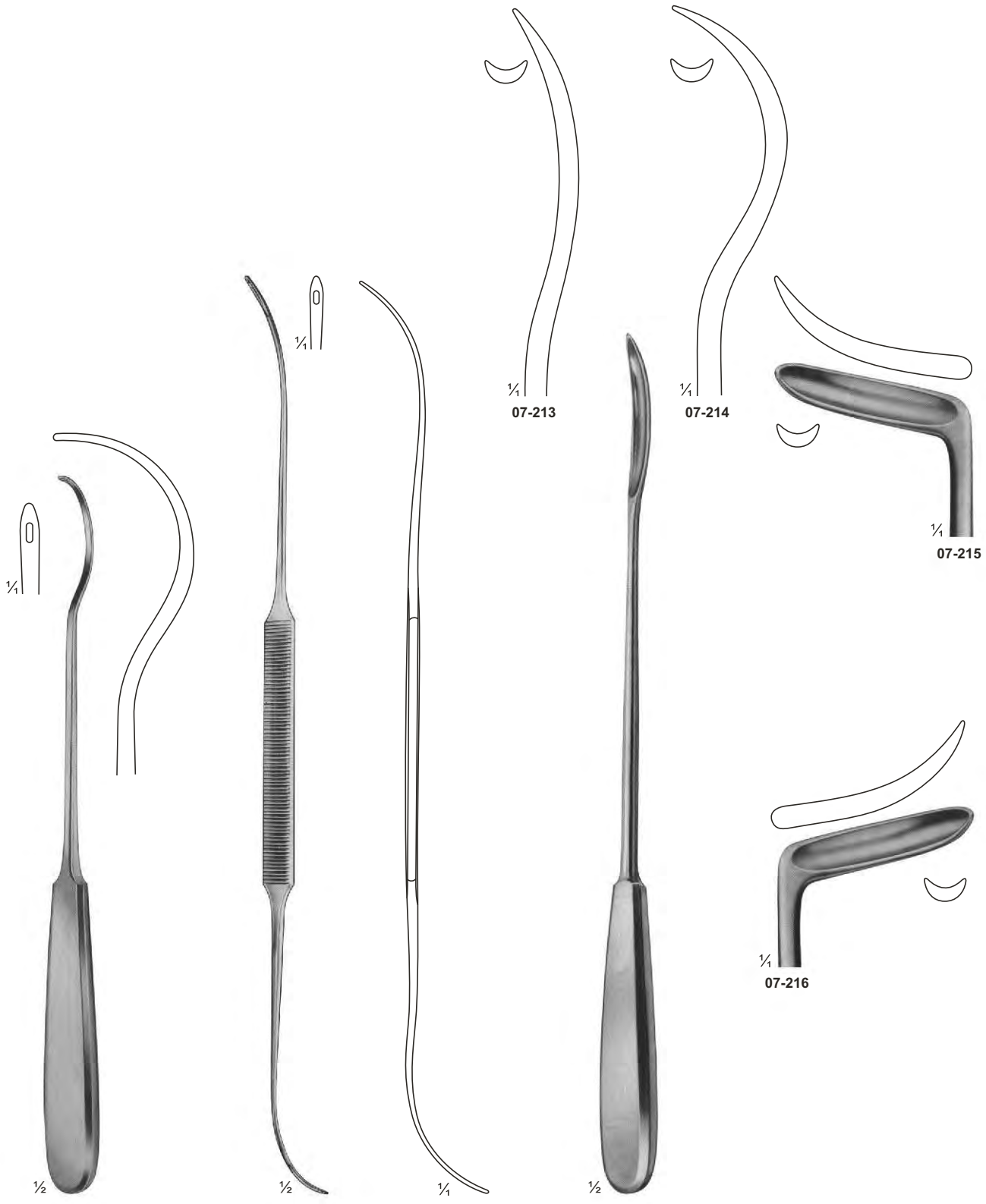

**07-211
BRUNNER**
240 mm

**07-212
SCHMIEDEN-DICK**
320 mm

**07-213 - 216
BRUNNER**
Guiding Probes
300 mm

Guiding Probes

REALSTAR SURGICAL INSTRUMENTS

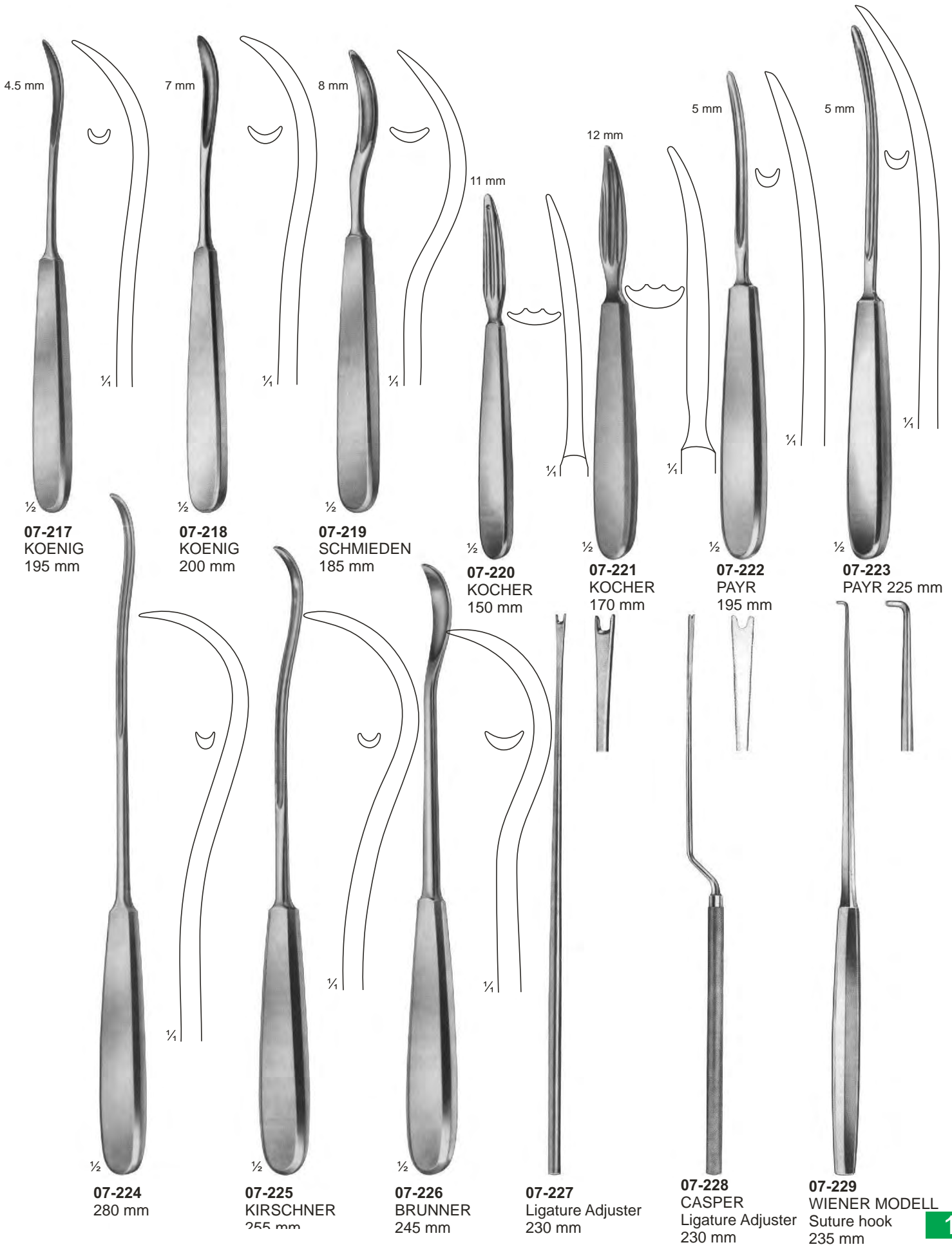

07-217
KOENIG
195 mm

07-218
KOENIG
200 mm

07-219
SCHMIEDEN
185 mm

07-220
KOCHER
150 mm

07-221
KOCHER
170 mm

07-222
PAYR
195 mm

07-223
PAYR
225 mm

07-224
280 mm

07-225
KIRSCHNER
255 mm

07-226
BRUNNER
245 mm

07-227
Ligature Adjuster
230 mm

07-228
CASPER
Ligature Adjuster
230 mm

07-229
WIENER MODELL
Suture hook
235 mm

Probes

REALSTAR SURGICAL INSTRUMENTS



07-242
2,5 mm
07-243
2,5 mm
07-244
3,0 mm

07-242 145 mm
07-243 160 mm
07-244 200 mm
Probes with eye



1,5 mm

07-245
Myrtle leaf probe
145 mm



2,0 mm

07-246 130 mm
07-247 145 mm
07-248 160 mm
07-249 180 mm
07-250 200 mm



1/2

07-251
Probes



1/2

07-252
Double ended probe,
malleable, diam. of tips
3 mm with hole
190 mm



07-253
Double ended probes,
tin, malleable,
diam. of tips
3,5 mm with hole
100 mm



1/4

07-254
Double ended probes,
tin, malleable,
diam. of tips 4 mm
400 mm



1/3

07-255 1,5 mm
07-256 2,0 mm
07-257 2,5 mm
300 mm

Probes

REALSTAR SURGICAL INSTRUMENTS



07-242 2,5 mm
07-243 2,5 mm
07-244 3,0 mm

1/2

07-242 145 mm
07-243 160 mm
07-244 200 mm
 Probes with eye



1,5 mm

1/2

07-245
 Myrtle leaf probe
 145 mm



2,0 mm

1/2

07-246 130 mm
07-247 145 mm
07-248 160 mm
07-249 180 mm
07-250 200 mm



1/2

07-251
 Probes



1/2

07-252
 Double ended probe,
 malleable, diam. of tips
 3 mm with hole
 190 mm



07-253
 Double ended probes,
 tin, malleable,
 diam. of tips
 3,5 mm with hole
 250 mm 300 mm



1/4

07-254
 Double ended probes,
 tin, malleable,
 diam. of tips 4 mm
 400 mm



1/3

Ø tip
07-255 1,5 mm
07-256 2,0 mm
07-257 2,5 mm
 300 mm

Probes - Spatulas - Cotton Applicators

REALSTAR SURGICAL INSTRUMENTS



07-258
STACKE
100 mm



07-259
KILLIAN
165 mm



07-260
160 mm



07-261
SEIFFERT
180 mm



07-262
BOWMAN
130 mm

German Silver



07-263
SPATULA
145 mm



07-264
SPATULA
145 mm



07-265
Modell PICCOLO
Round Serrated
110 mm



07-266
Modell PICCOLO
Triangular Serrated end
110 mm



07-267
FARRELL
Round Serrated end
110 mm



07-268
LATHBURY-FARRELL
Triangular Serrated end
110 mm



Cotton Applicators

REALSTAR SURGICAL INSTRUMENTS



07-269
BUCK
 Rough, spiral end
 120 mm



07-270
Triangular
 serrated end
 140 mm



07-271
Rough, spiral end
 140 mm



07-272
Rough, spiral end
 140 mm



07-273
Rough, spiral end
 140 mm



07-274
FARRELL
 Round,
 serrated end
 140 mm



07-275
LATHBURY-FARRELL
 Triangular,
 serrated end
 140 mm



07-276
FARRELL
 Rough,
 spiral end
 160 mm



07-277
LATHBURY-FARRELL
 Triangular,
 serrated end
 160 mm



07-278
Triangular,
 serrated end
 160 mm



07-279
Rough,
 spiral end
 180 mm



07-280
Rough,
 spiral end
 180 mm



07-281
Rough,
 spiral end
 270 mm

Clip Applying Forceps - Suture Set

**REALSTAR SURGICAL
INSTRUMENTS**



½

07-282
MICHEL
125 mm



½

07-283
HEGENBARTH
120 mm



½

07-284
WACHENFELDT
120 mm



½

07-285
WACHENFELDT
120 mm



½

07-286
MICHEL
125 mm



½

07-287
MICHEL modif.
130 mm



½

07-288
HEATH
135 mm



½

07-289
COLLIN
135 mm

**REALSTAR SURGICAL
INSTRUMENTS**

SERVING TO SAVE LIVES

Clip Applying Forceps - Suture Set

REALSTAR SURGICAL INSTRUMENTS



07-290

Suturing instruments set, in metal case consisting of: Scissors, curved, sharp/sharp, 115mm
25 MICHEL clip, 16 x 3mm
1 Delicate tissue forceps, 130mm
1 Scalpel, bellied
1 MATHIEU needle holder, 140mm
1 Perforated metal case, stainless containing:
1 Suture needle
1 item 1 item



07-291

Pocket instrument set, in metal case consisting of:

Bottom tray

1 MATHIEU needle holder, 140mm
1 MICHEL clip forceps, combined
1 Myrtle leaf probe, 130mm
1 Sharp double curette
1 Skin hook
1 Detachable scalpel handle, no.4
1 Perforated metal case, containing
6 Scalpel blades BB 520
1 Perforated metal case, stainless, containing
1 Suture needle
1 item
1 item

Top tray

1 Tissue forceps, 130mm
1 KOCHER haemostatic forceps, 130mm
1 Straight surgical scissors, 130mm
1 Dissecting forceps, 130mm
1 FEILCHENFELD splinter forceps, 115mm
25 MICHEL clip, 16 x 3mm
1 Flacon of suture skin, sterile in alcohol



07-292

Pocket instrument set, in metal case consisting of:

Bottom tray

1 MAYO-HEGER needle holder, 150mm
1 MICHEL clip forceps, combined
1 Myrtle leaf probe, 130mm
1 Sharp double curette
1 Skin hook
1 Detachable scalpel handle, no. 4
1 Perforated metal case, consisting
6 Scalpel blades BB 520
1 Perforated metal case, stainless, consisting:
1 Suture needle

Bottom tray

1 Tissue forceps, 130mm
1 CRILE haemostatic forceps, 140mm
1 Straight surgical scissors, 130mm
1 Dissecting forceps, 130mm
1 FEILCHENFELD splinter forceps, 115mm
25 MICHEL clip, 16 x 3mm
1 Flacon of suture silk, sterile in alcohol

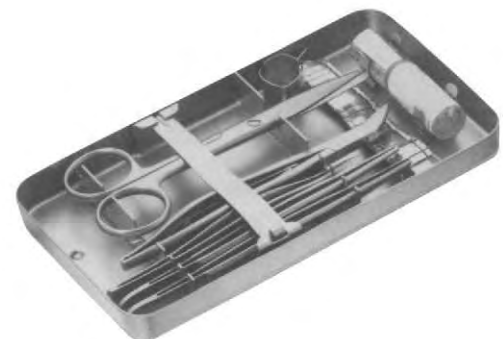

Clip Applying Forceps - Suture Set

REALSTAR SURGICAL INSTRUMENTS

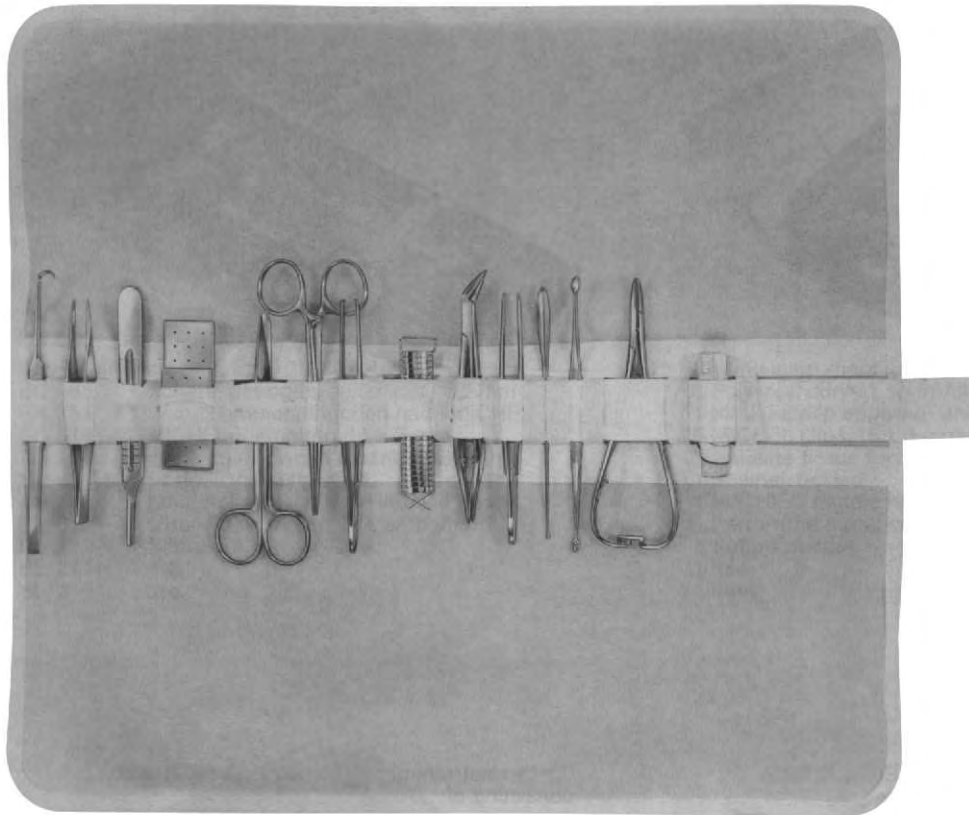

07-293

Pocket instrument set in metal case 170 x 90mm with sterilizable canvas roll consisting of:

- 1 Myrtle leaf probe, 130mm
- 1 Sharp double curette
- 1 FEILCHENFELD splinter forceps, 115mm
- 1 Dissecting forceps, 130mm
- 1 Tissue forceps, 130mm

- 1 Straight surgical scissors, 130mm
- 1 Scalpel handle no. 4
- 1 Perforated metal case, consisting of 6 scalpel blades BB 520
- 1 KOCHER haemostatic forceps, 130mm
- 1 Skin hook
- 1 MATHIEU needle holder, 140mm
- 1 Tube of suture skin, sterile in alcohol
- 1 MICHEL clip forceps, 120mm

- 25 MICHEL clip, 16 x 3mm**
- 1 Perforated metal case, stainless, consisting:**
- 1 Suture needle**
- 1 item**
- 1 item**

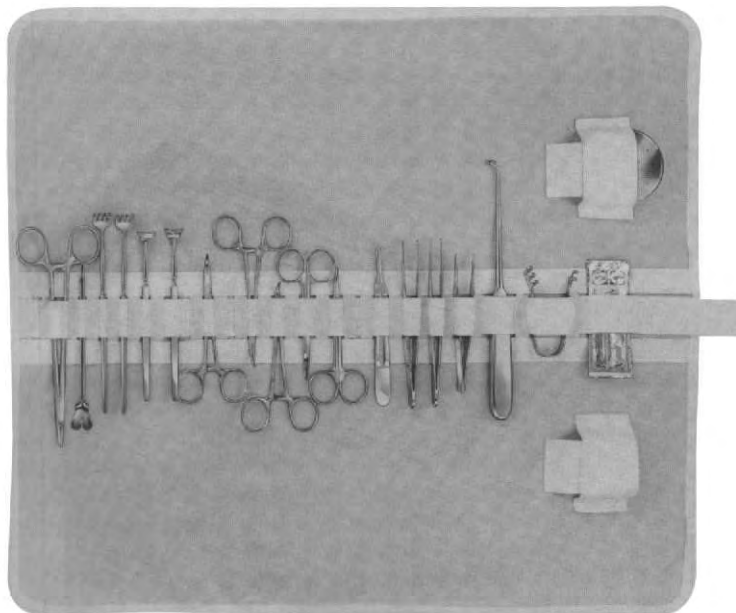

07-294

Venae sectio set, in sterilizable canvas roll consisting of:

- 1 Tissue forceps, 1 x 2 teeth, 140mm
- 1 Dissecting forceps, 145mm
- 1 FEILCHENFELD straight scissors, sharp, 110mm
- 1 curved scissors, blunt, 115mm
- 1 HALSTED mosquito forceps, curved on flat,

- 1 DESCHAMPS needle, blunt, 210mm
- 1 DOYEN Director, curved, 140mm
- 2 Wound retractors, 4 blunt prongs, 160mm
- 2 DESMARRES wound retractors, 135mm
- 1 FINSEN retractors, 2 x3 blunt prongs, 80mm

- 1 Scalpel handle no. 4
- 4 Sterile scalpel blades, no 18, single peel pack
- 1 Needle box, perforated, round, diam. 65mm
- 1 HEGAR-MAYO DUROGRIP needle holder, 180mm

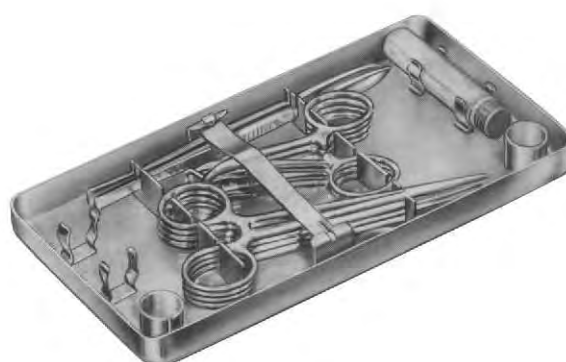

07-295

Venae sectio set, in metal case
consisting of:

Bottom tray

- 1 MATHIEU needle holder, fine pattern 140mm
- 1 Ligature needle, fine short pattern
- 1 DOYEN director, curved
- 1 HEGENBARTH clip forceps,
- 1 ELSCHNIG tissue forceps, 1 x 2 teeth fine, 150mm
- 1 Dressing forceps, fine 105mm
- 1 Tissue forceps, 1 x 2 teeth, 110mm
- 1 Vessel scissors, straight, with 1 ball point, 110mm
- 1 Vessel scissors, curved, pointed 105mm
- 1 FINSEN retractor
- 1 Perforated needle case

Top tray

- 1 Scalpel, pointed
- 1 Scalpel, bellied
- 2 HALSTED mosquito forceps, curved, 125mm
- 2 HALSTED mosquito forceps, straight, 1x 2 teeth, 125mm
- 3 BACKHAUS towel forceps, 90mm
- 2 Flacon holder

Nerve - and Vessel Hooks

REALSTAR SURGICAL INSTRUMENTS

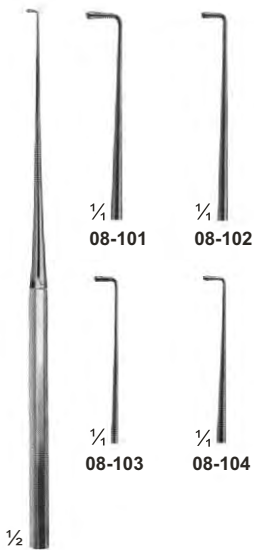

08-101 - 104
WAGENER
150 mm

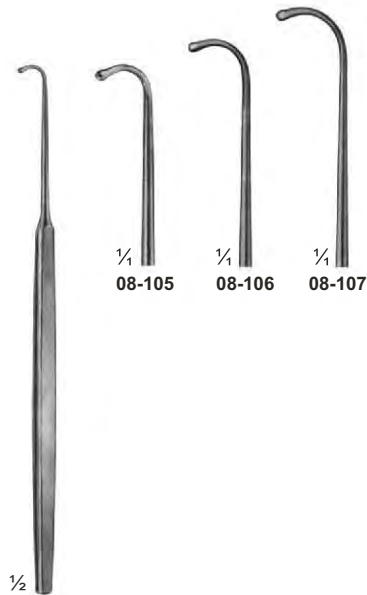

08-105 - 107
GRAEFE
140 mm



08-108
BROM
Vein hook
170 mm



08-109
CRILE
200 mm



08-110 - 111
CUSHING
190 mm

Nerve - and Vessel Hooks

REALSTAR SURGICAL INSTRUMENTS

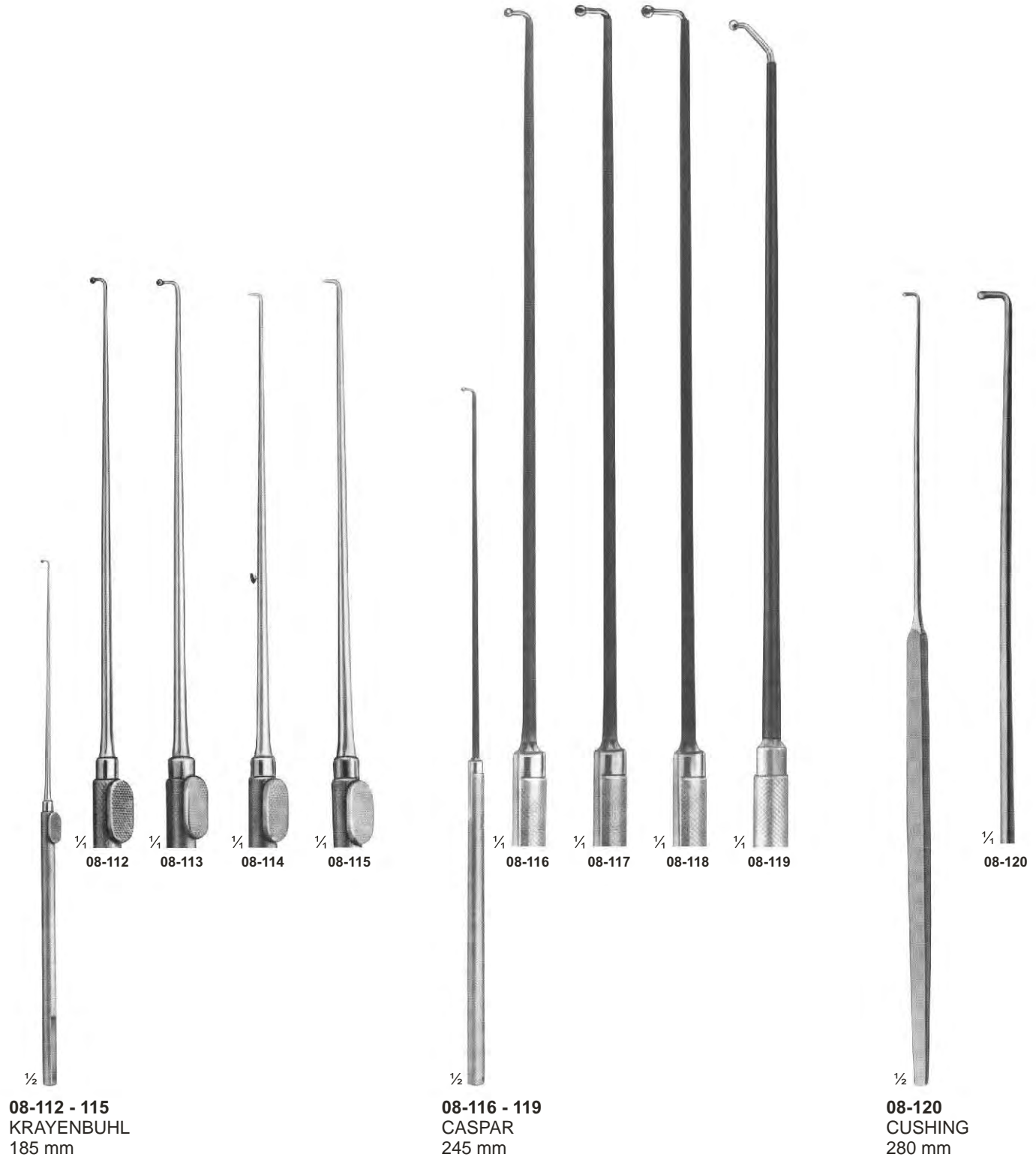

REALSTAR SURGICAL INSTRUMENTS



08-121 Sharp
08-122 Blunt
GRAEFE
125 mm



08-123 125 mm
08-124 130 mm
Sharp
GUTHRIE



08-125 130 mm
08-126 135 mm
Sharp
ROLLET
08-127 135 mm
Blunt



08-128
FRAZIER
Dura Retractors
130 mm



08-129
TONNIS
Dura Retractors
150 mm



08-130
KILNER
160 mm

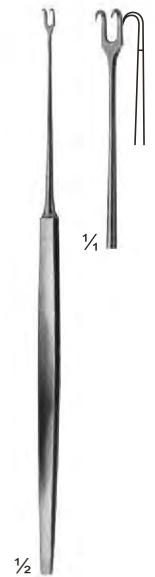

08-131
FREER
150 mm



08-132
MULLER
150 mm



08-133
MULLER
150 mm



08-134
COTTLE
160 mm



08-135
COTTLE
160 mm



08-136
JAEGAR
135 mm



08-137 - 140
JOSEPH
165 mm



08-137



08-138
3 mm



08-139
6 mm



08-140
8 mm



08-141 - 142
GILLIES
180 mm

08-143
KILNER
Sharp
80 mm



08-144
CONVERSE
Blunt
120 mm

Wound - Trachea Retractors

REALSTAR SURGICAL INSTRUMENTS

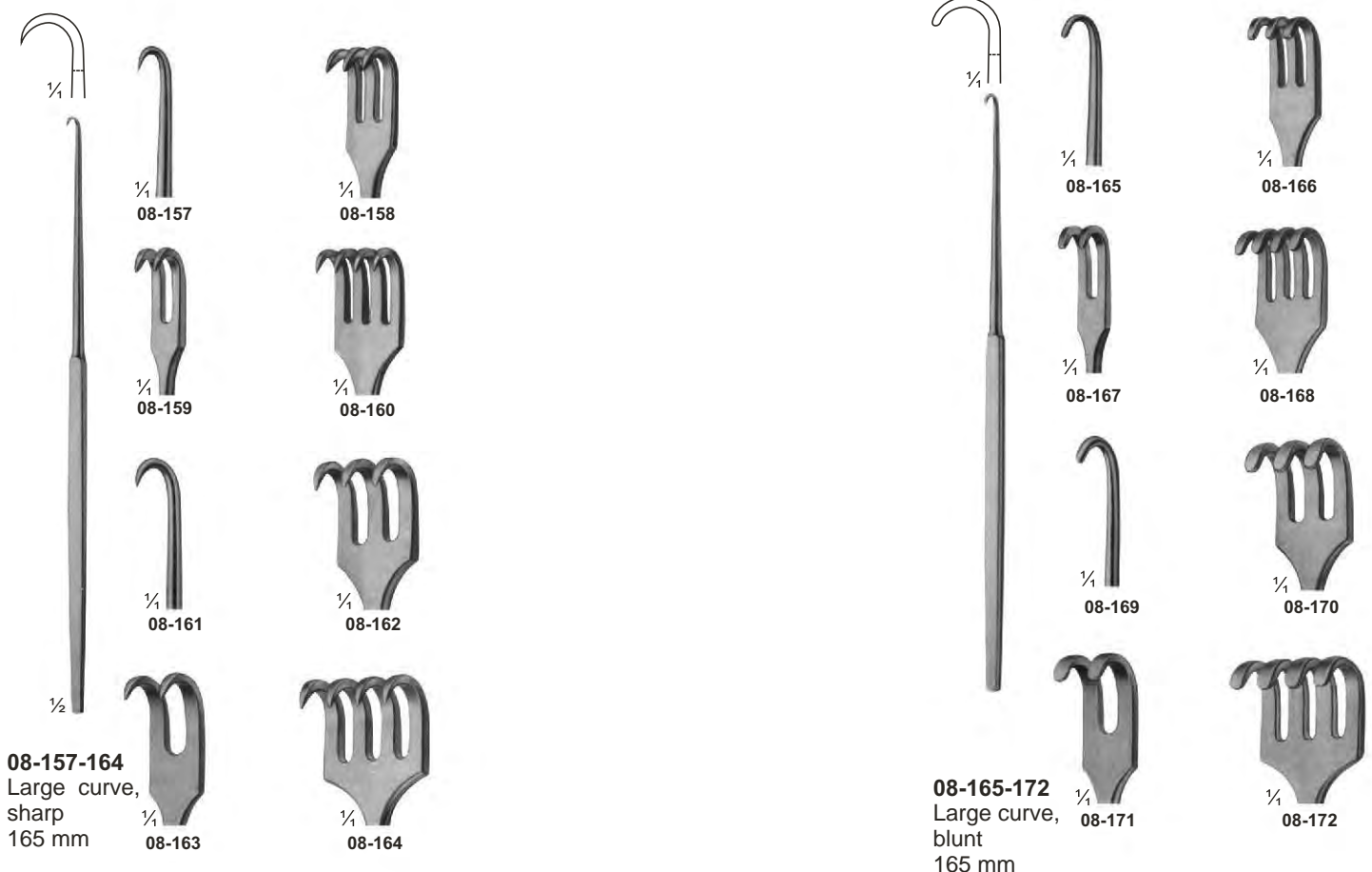
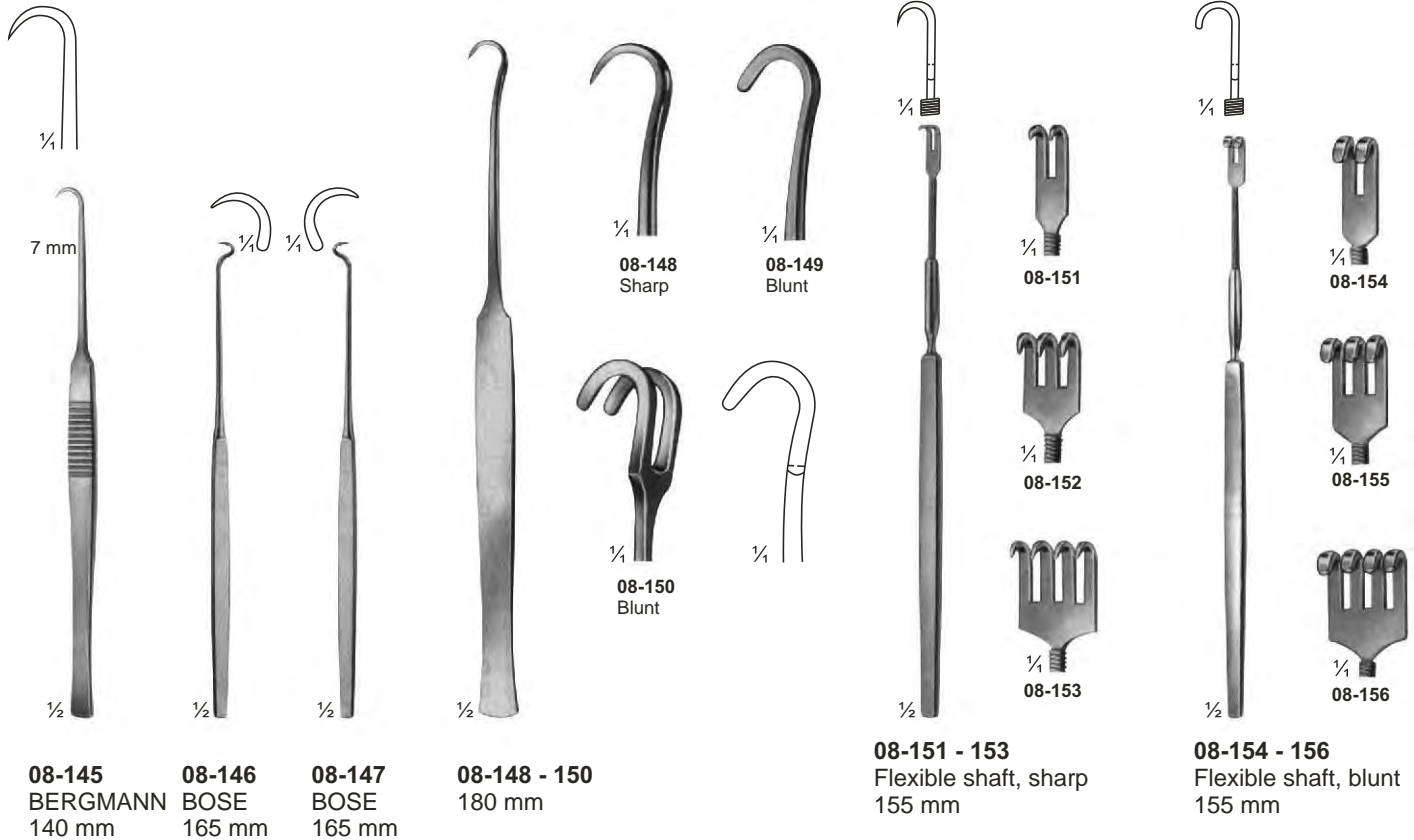

Retractors With Treangle Handle

REALSTAR SURGICAL INSTRUMENTS

08-173
MANNERFELT modif.
sharp
135 mm

08-174
MANNERFELT modif.
sharp
155 mm

08-175
MANNERFELT modif.
sharp
155 mm

08-176 - 178
MANNERFELT modif.
Small curve, sharp
155 mm

08-176

08-177

08-178

08-179 - 181
MANNERFELT modif.
Large curve, blunt
155 mm

08-179

08-180

08-181

08-182
15 x 6 mm

08-183
20 x 6 mm

08-184
25 x 6 mm

08-185
30 x 8 mm

08-186
12 x 12 mm

08-187
12 x 14 mm

08-188
14 x 16 mm

08-186 - 188
MANNERFELT modif.
Saddle hooks,
155 mm

08-189
MANNERFELT modif.
Saddle hooks, fenestrated
155 mm

Retractors

REALSTAR SURGICAL INSTRUMENTS



08-190
FOMON
145 mm



08-191 - 192
160 mm



08-193 - 194
LANGENBECK-GREEN
160 mm

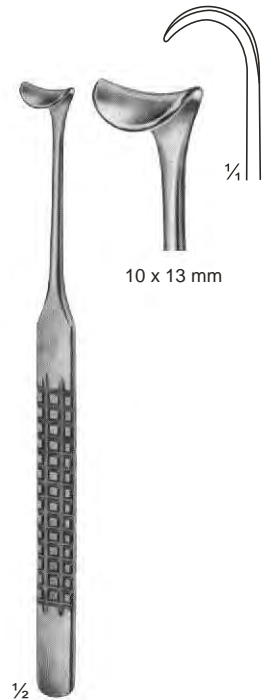

08-195
160 mm



08-196 - 201
MEYERDING
Fig. A - Fig. F
180 mm



A
08-196
18 x 7 mm

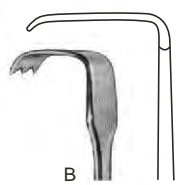

B
08-197
16 x 5 mm

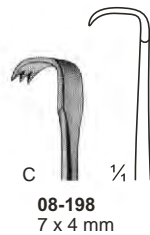

C
08-198
7 x 4 mm



D
08-199
5 x 10 mm



E
08-200
11 x 4 mm



F
08-201
6 x 4 mm

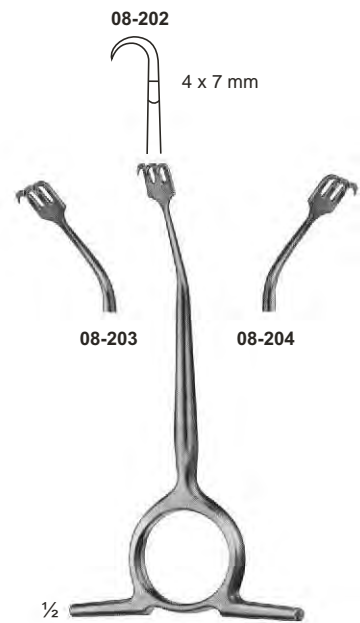

08-202 - 204
WILLIGER
120 mm

Retractors

REALSTAR SURGICAL INSTRUMENTS



08-205
EMMET
Fistula hook
220 mm



08-206
SIMON
Fistula hook
220 mm

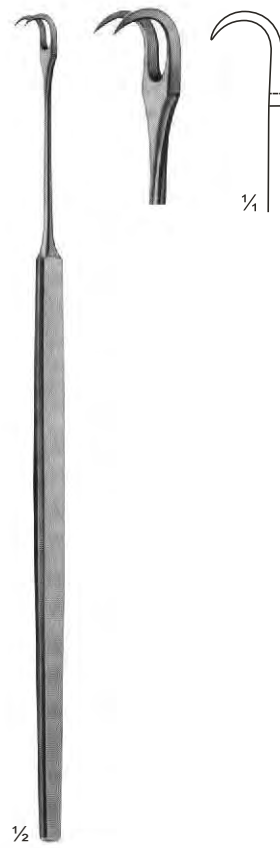

08-207
SIMON
Fistula hook
220 mm



08-208
LANGE
Fistula hook
230 mm



12 x 6 mm

08-209

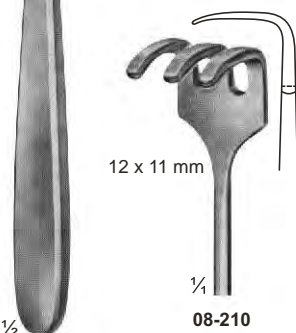

12 x 11 mm

08-210

08-209 - 210
Tendon hooks
175 mm

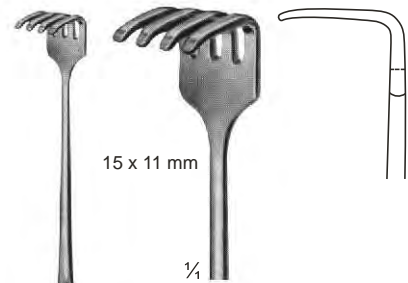

15 x 11 mm

08-211

08-211
KLAPP
Tendon hooks
175 mm

Retractors

REALSTAR SURGICAL INSTRUMENTS

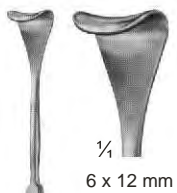

1/4
6 x 12 mm
1/2
08-212
MASING
140 mm

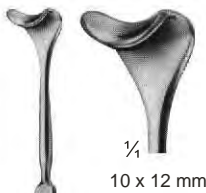

1/4
10 x 12 mm
1/2
08-213
COTTLE
140 mm



1/4
9 x 9 mm
1/2
08-214 - 218
DESMARRES
140 mm



1/4
9 x 12 mm



1/4
11 x 14 mm



1/4
12 x 16 mm



1/4
13 x 18 mm

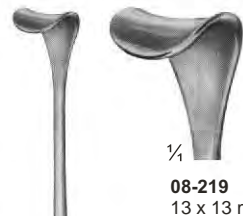

1/4
08-219
13 x 13 mm

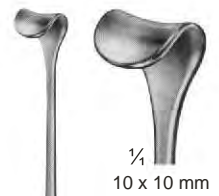

1/4
10 x 10 mm

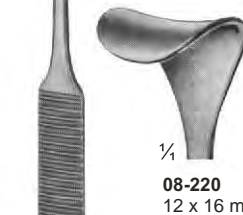

1/4
08-220
12 x 16 mm

1/2
08-219 - 220
KONIG
180 mm

1/2
08-221
CUSHING-KOCHER
175 mm

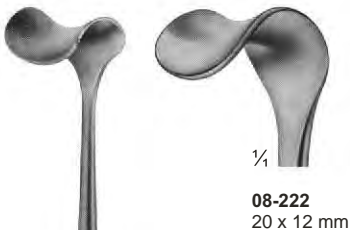

1/4
08-222
20 x 12 mm



1/4
08-223
20 x 15 mm

1/2
08-222 - 223
KOCHER
205 mm



1/4
13 x 6 mm

1/2
08-224
SCHOENBORN
200 mm



1/4
08-225
10 x 13 mm

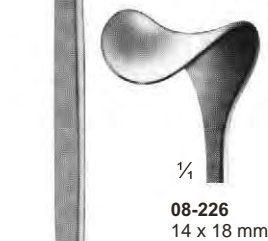

1/4
08-226
14 x 18 mm

1/2
08-225 - 226
CUSHING
205 mm

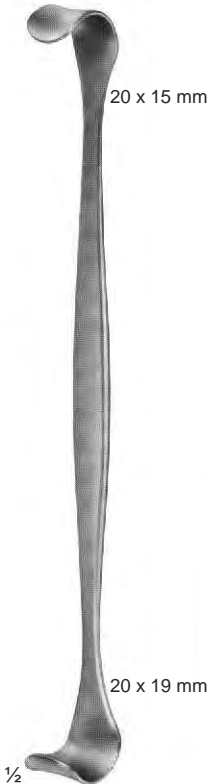

20 x 15 mm

20 x 19 mm

1/2
08-227
205 mm

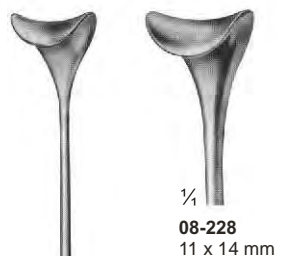

1/4
08-228
11 x 14 mm

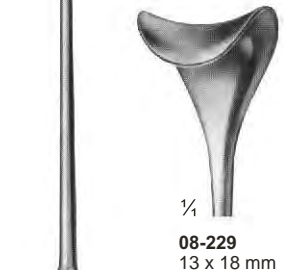

1/4
08-229
13 x 18 mm

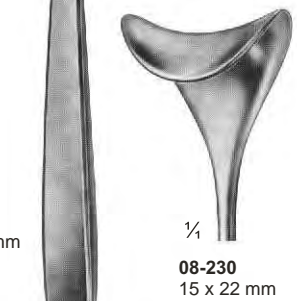

1/4
08-230
15 x 22 mm

1/2
08-228 - 230
CUSHING
250 mm

Retractors

REALSTAR SURGICAL INSTRUMENTS

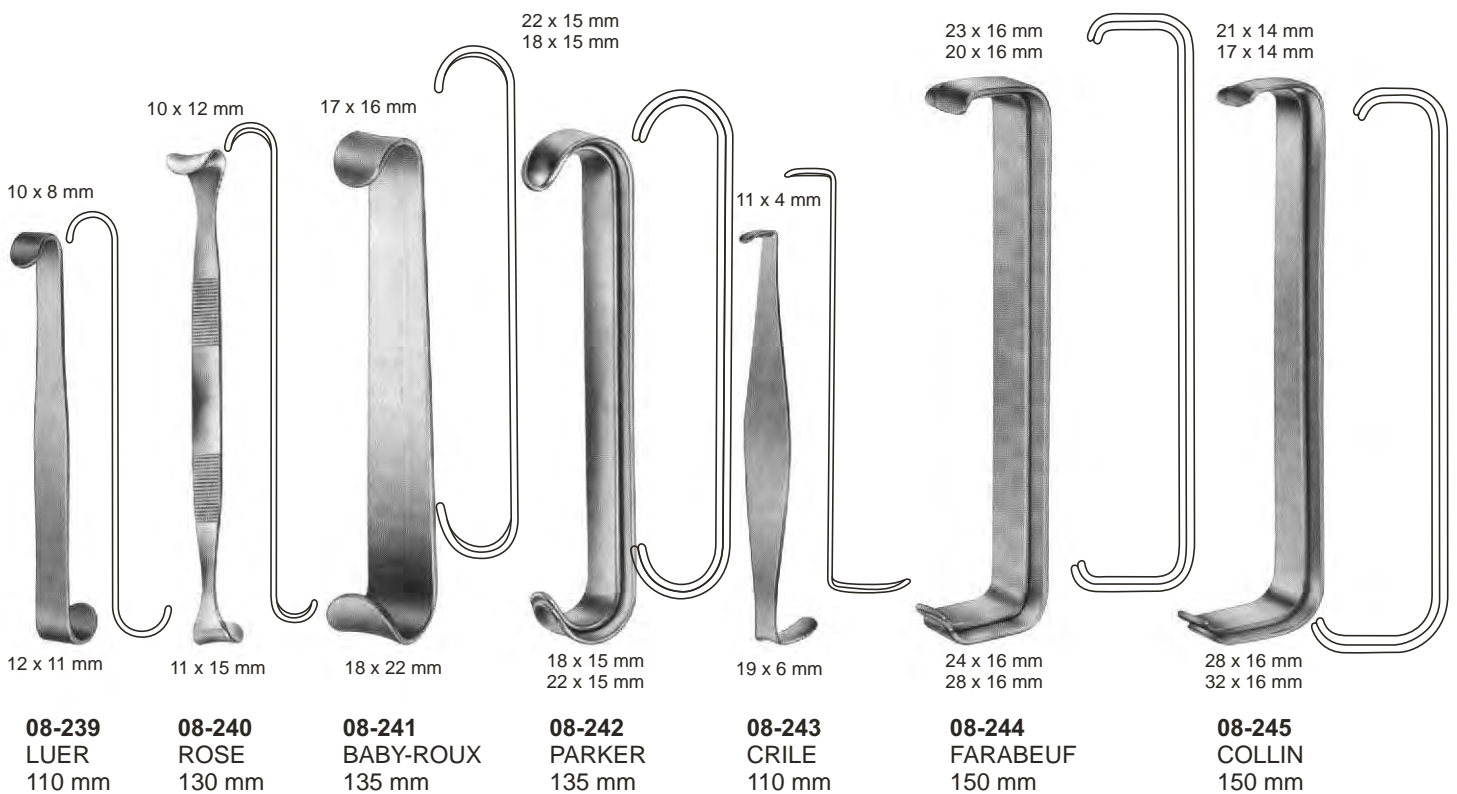

Retractors

REALSTAR SURGICAL INSTRUMENTS



Bone Retractors and Retractors

REALSTAR SURGICAL INSTRUMENTS



08-254
KOCHER
Sharp
205 mm



08-255
KOCHER
Sharp
220 mm



08-256
KOCHER
Blunt
220 mm



08-257
VOLKMANN
Sharp
220 mm



08-258
VOLKMANN
Sharp
220 mm



08-259 - 266
VOLKMANN
225 mm

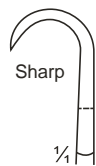

08-259
9 x 8 mm



08-260
9 x 13 mm



08-261
9 x 19 mm



08-262
9 x 29 mm

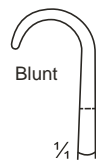

08-263
8,5 x 8 mm



08-264
8,5 x 13 mm



08-265
8,5 x 19 mm



08-266
8,5 x 29 mm

Retractors

REALSTAR SURGICAL INSTRUMENTS

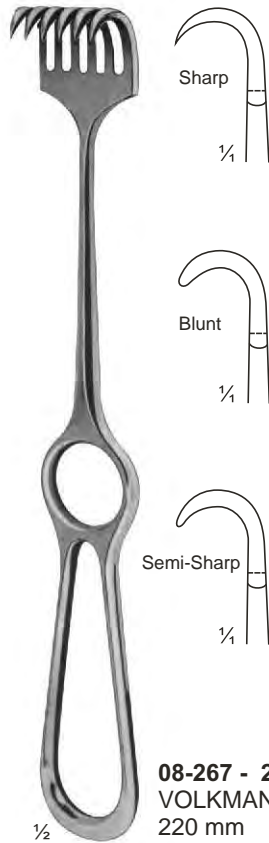

08-267 - 280
VOLKMANN
220 mm



08-267
9 x 8 mm



08-268
9 x 13 mm



08-269
9 x 19 mm



08-270
9 x 29 mm



08-271
9 x 40 mm

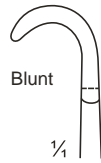

08-272
8 x 8 mm



08-273
8 x 13 mm



08-274
8 x 19 mm



08-275
8 x 29 mm



08-276
8 x 40 mm



08-277
8,5 x 8 mm



08-278
8,5 x 13 mm



08-279
8,5 x 19 mm



08-280
8,5 x 29 mm

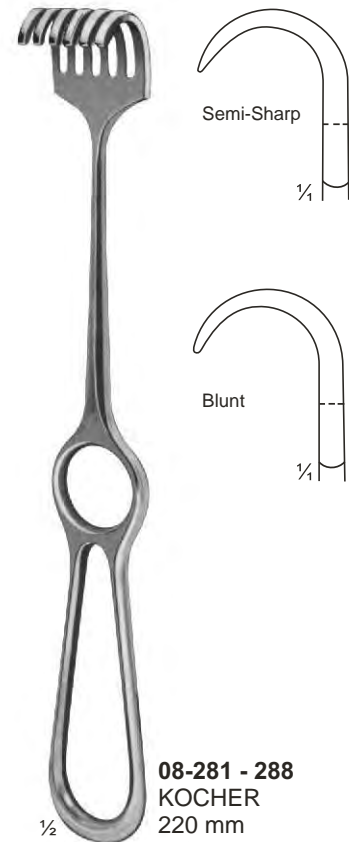

08-281 - 288
KOCHER
220 mm



08-281
16 x 9 mm



08-282
16 x 14 mm



08-283
16 x 20 mm



08-284
16 x 30 mm

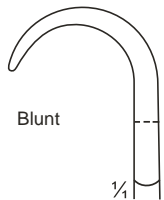

08-285
15,5 x 9 mm



08-286
15,5 x 14 mm



08-287
15,5 x 20 mm



08-288
15,5 x 30 mm

Retractors, Deep form

REALSTAR SURGICAL INSTRUMENTS

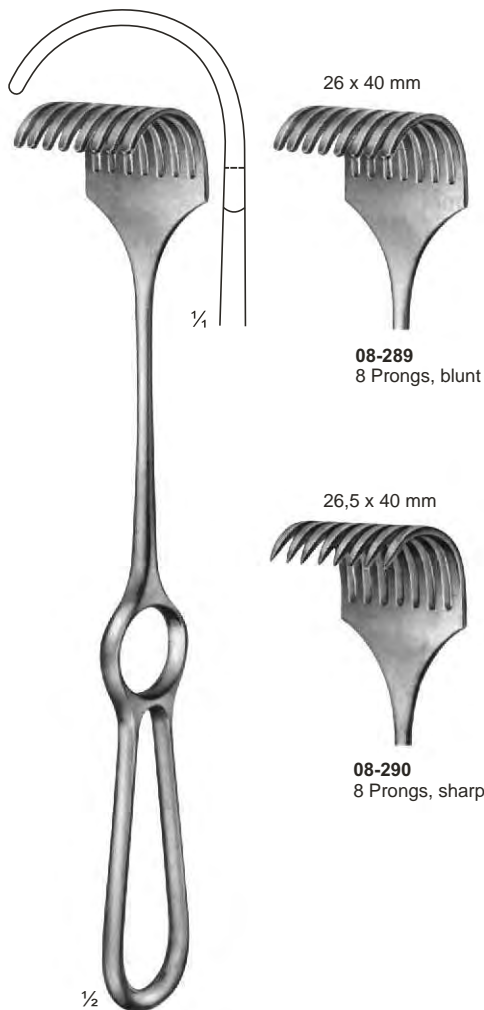

08-289 - 290
KORTE
240 mm

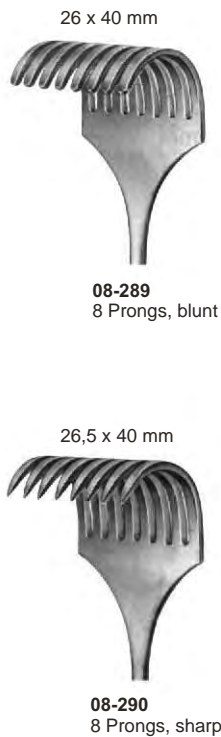

08-291 - 294
ISRAEL
255 mm

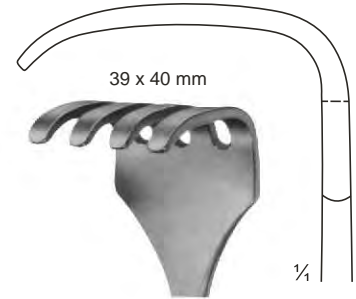

08-291
4 Prongs, blunt

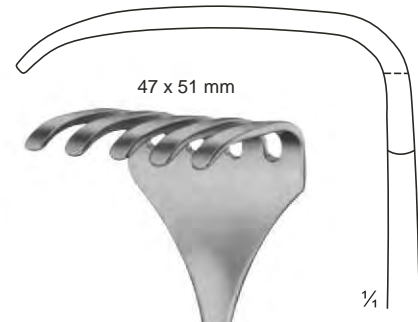

08-292
5 Prongs, blunt

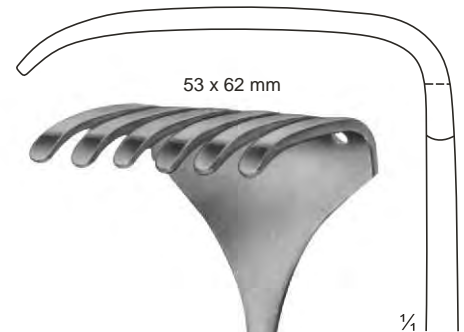

08-293
6 Prongs, blunt

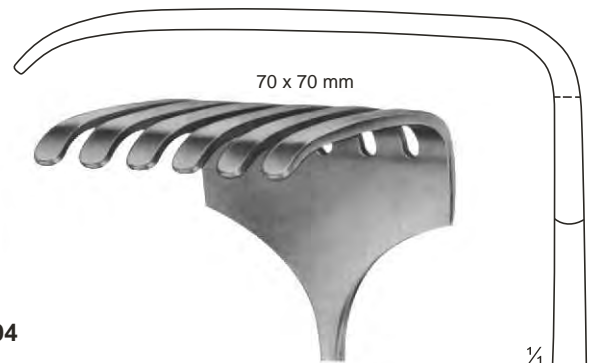

08-294
6 Prongs, blunt

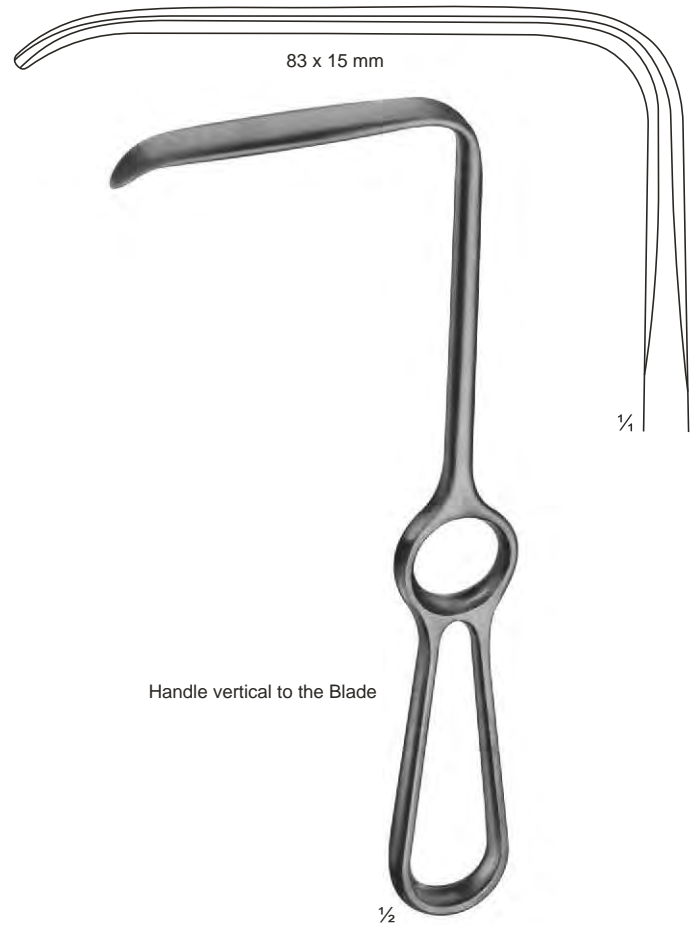

08-295 - 300
LANGENBECK
210 mm
08-295 28 x 10 mm
08-296 28 x 14 mm
08-297 33 x 14 mm
08-298 28 x 16 mm
08-299 40 x 10 mm
08-300 40 x 13 mm

08-301 - 307
KOCHER-LANGENBECK
215 mm
08-301 25 x 6 mm
08-302 35 x 8 mm
08-303 35 x 11 mm
08-304 35 x 15 mm
08-305 41 x 11 mm
08-306 55 x 11 mm
08-307 70 x 14 mm

08-308
LANGENBECK
215 mm

Retractors

REALSTAR SURGICAL INSTRUMENTS

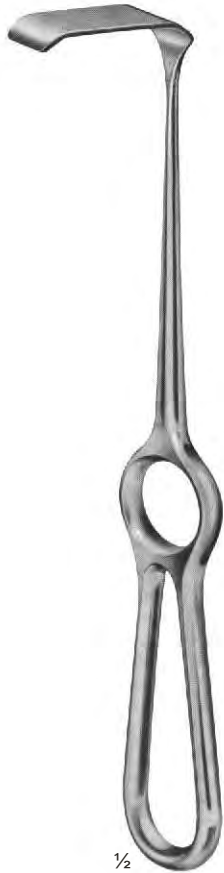

08-309 - 313
KOCHER
 230 mm

1/2



08-314 - 316
SAUERBRUCH
 225 mm

1/2

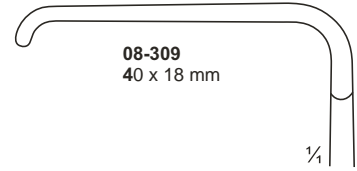

08-309
 40 x 18 mm

1/4

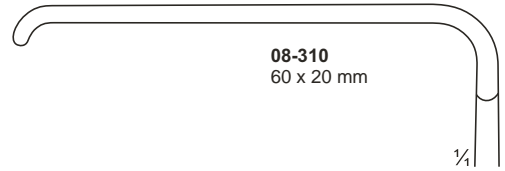

08-310
 60 x 20 mm

1/4

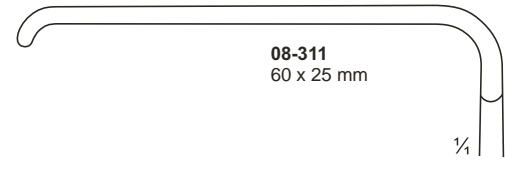

08-311
 60 x 25 mm

1/4

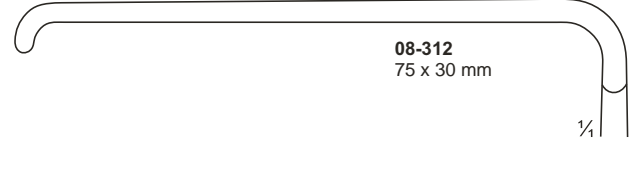

08-312
 75 x 30 mm

1/4

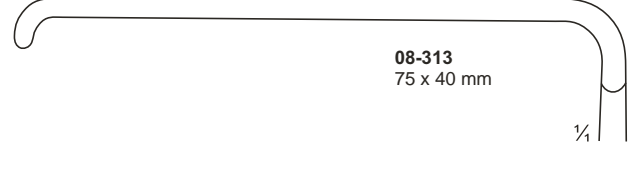

08-313
 75 x 40 mm

1/4

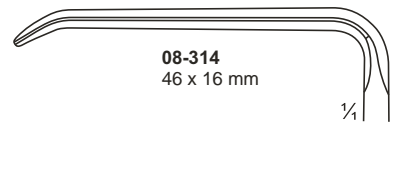

08-314
 46 x 16 mm

1/4

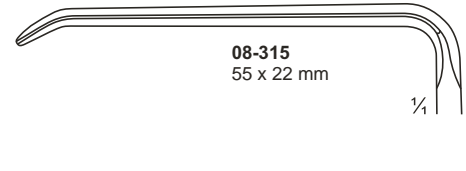

08-315
 55 x 22 mm

1/4

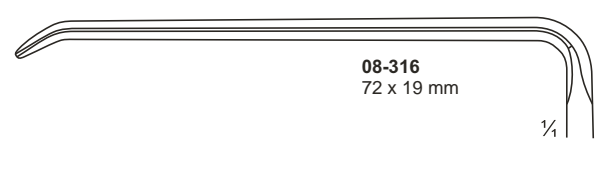

08-316
 72 x 19 mm

1/4

Retractors

REALSTAR SURGICAL INSTRUMENTS



1/2
08-317
15 x 15 mm
220 mm



1/2
08-318
20 x 22 mm
215 mm

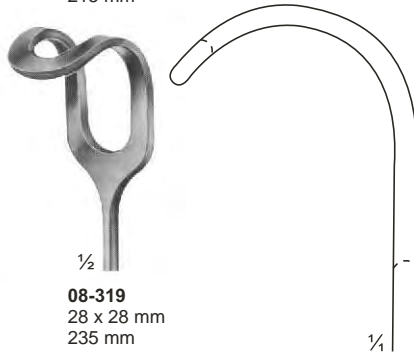

1/2
08-319
28 x 28 mm
235 mm

1/2
08-317 - 319
MIDDELDORPF



38 x 18 mm

1/2
08-320
BUCHS
205 mm



1/2
08-321
CASPAR
210 mm

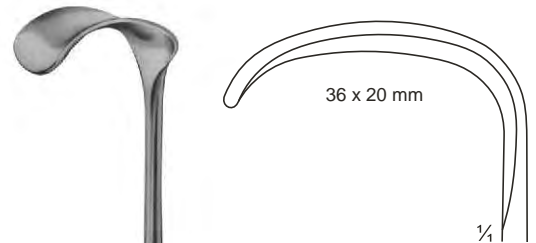

1/2
08-322
KOCHER
230 mm

Retractors

REALSTAR SURGICAL INSTRUMENTS



08-323 - 328
HOSEL
250 mm

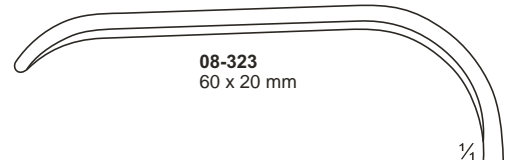

08-323
60 x 20 mm

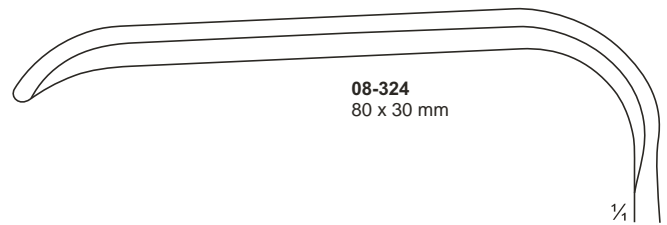

08-324
80 x 30 mm

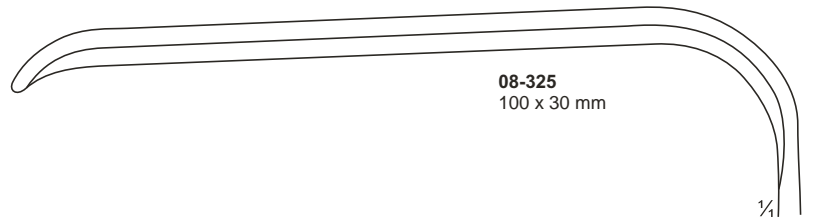

08-325
100 x 30 mm

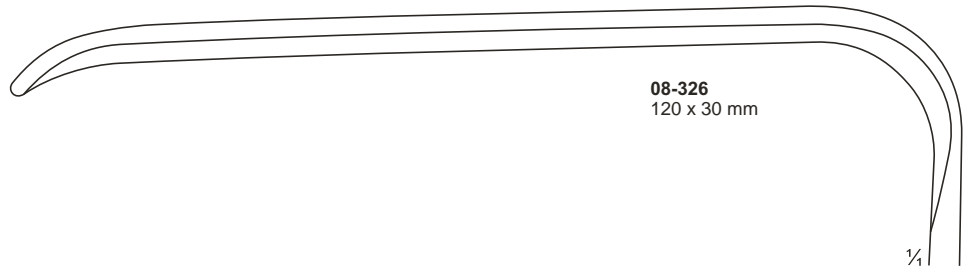

08-326
120 x 30 mm

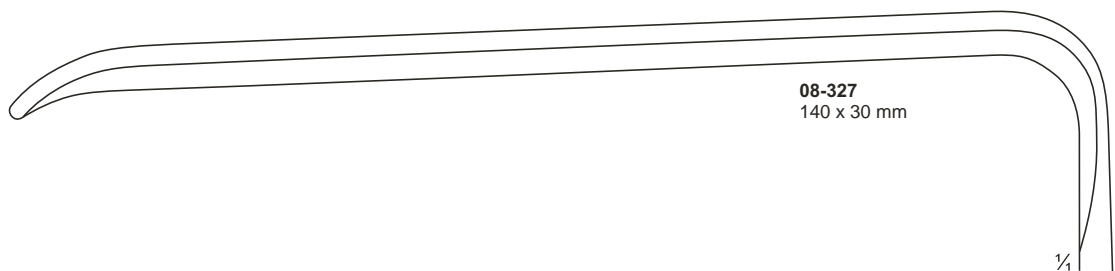

08-327
140 x 30 mm

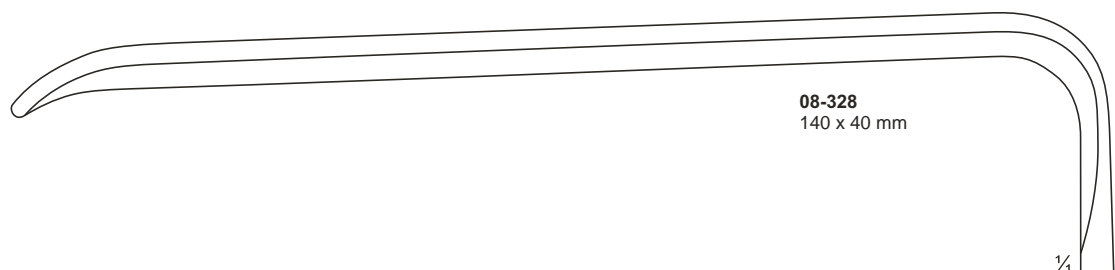

08-328
140 x 40 mm

Retractors

REALSTAR SURGICAL INSTRUMENTS

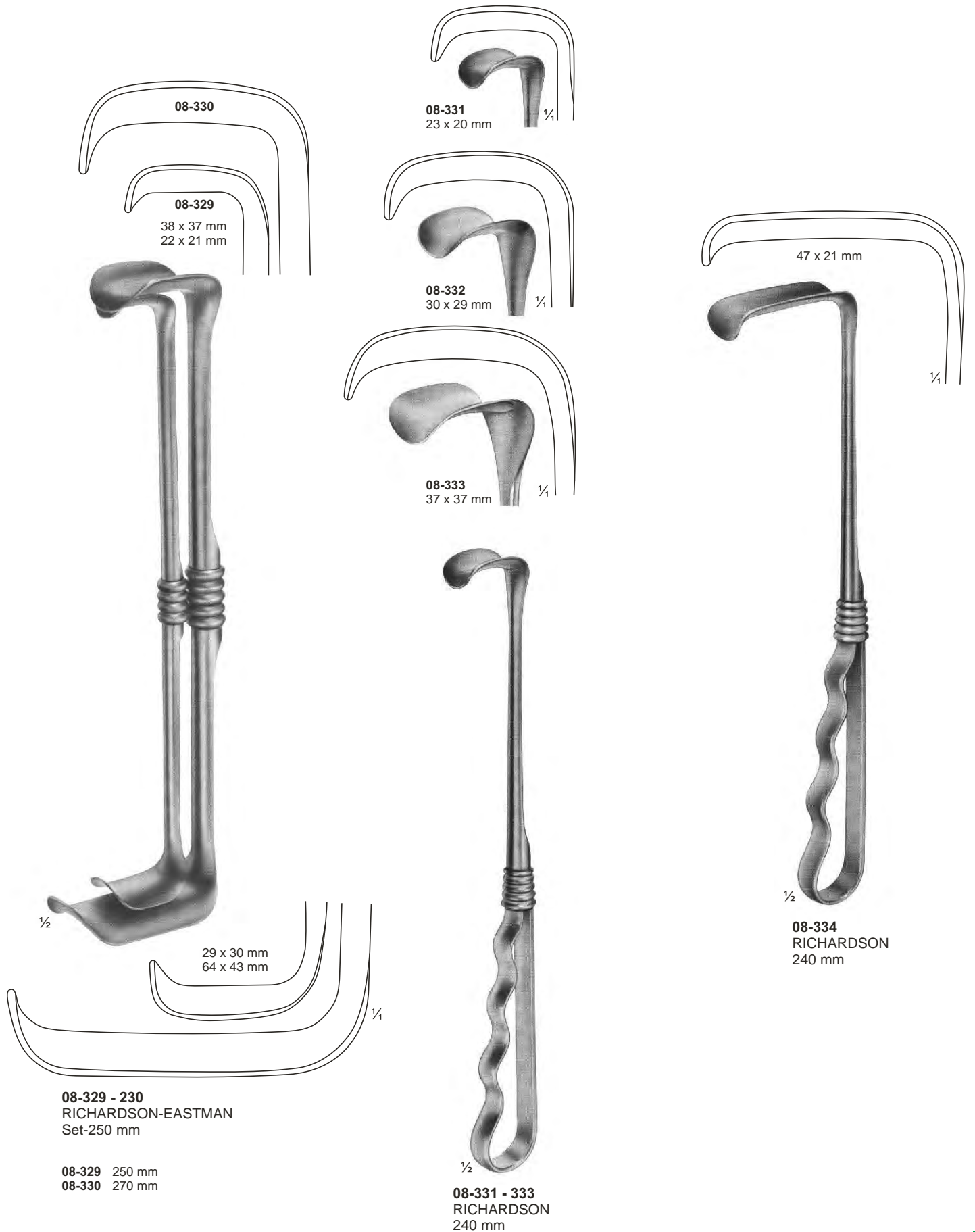

Retractors

REALSTAR SURGICAL INSTRUMENTS

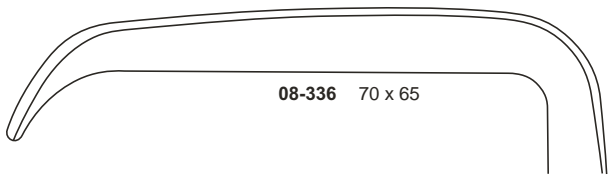

08-336 70 x 65

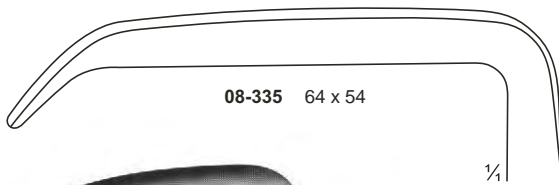

08-335 64 x 54



1/2

08-335 - 336
KELLY
260 mm

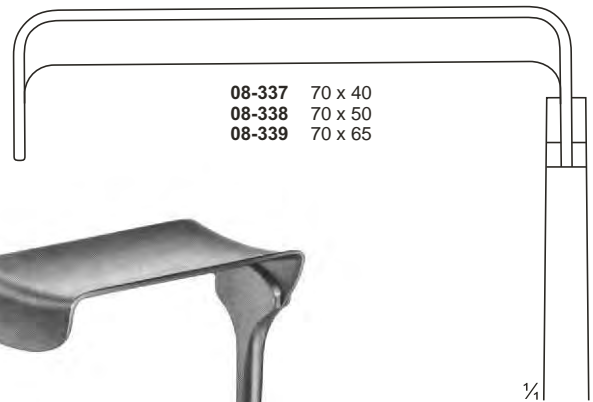

08-337 70 x 40
08-338 70 x 50
08-339 70 x 65



1/2

08-337 - 339
MORRIS
245 mm

Retractors For Deep Surgery

REALSTAR SURGICAL INSTRUMENTS



Retractors For Deep Surgery

REALSTAR SURGICAL INSTRUMENTS

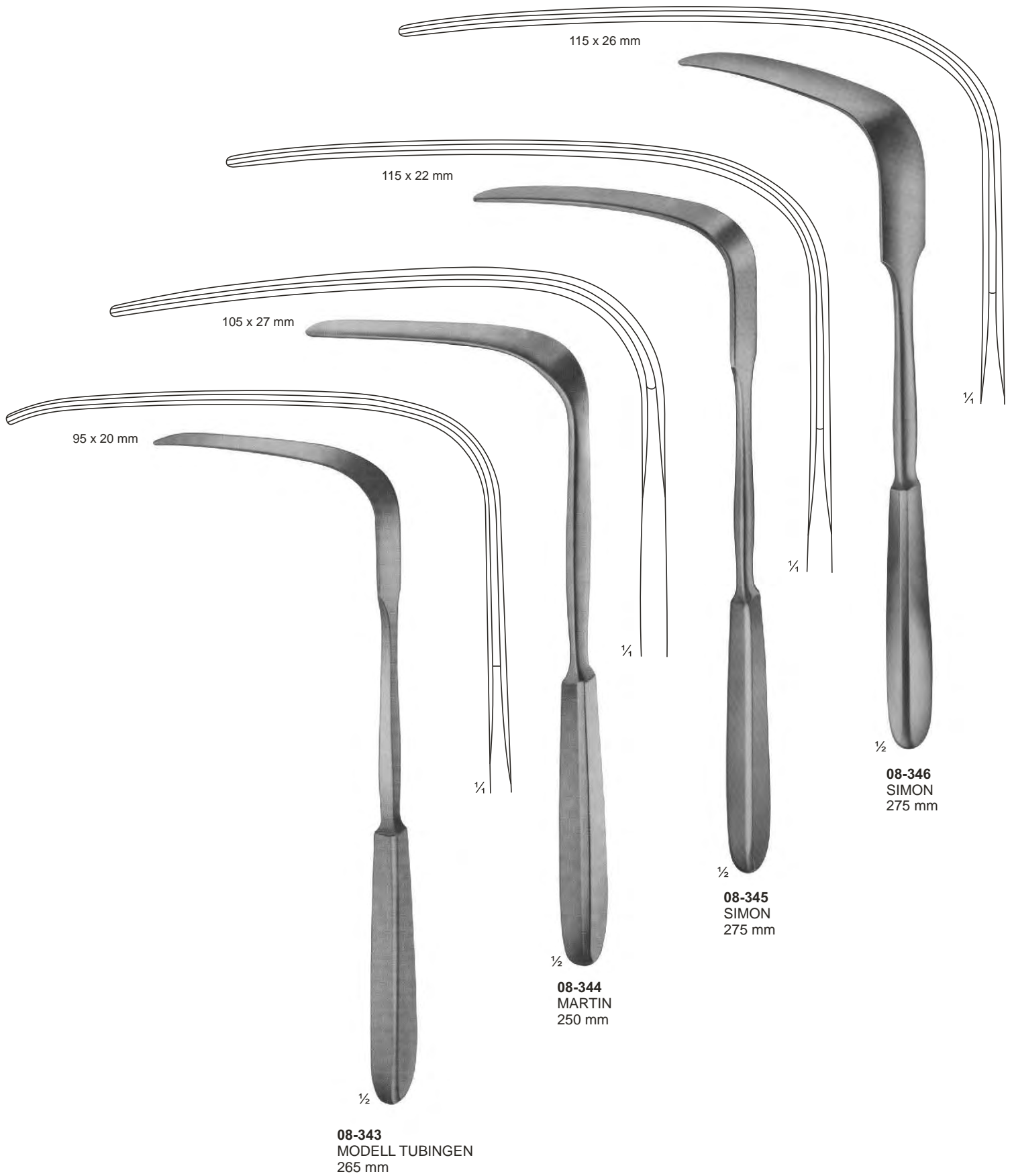

Vario Retractor System, Germ. Fed. Patent,
Germ. Fed. Regd.Des.

**REALSTAR SURGICAL
INSTRUMENTS**

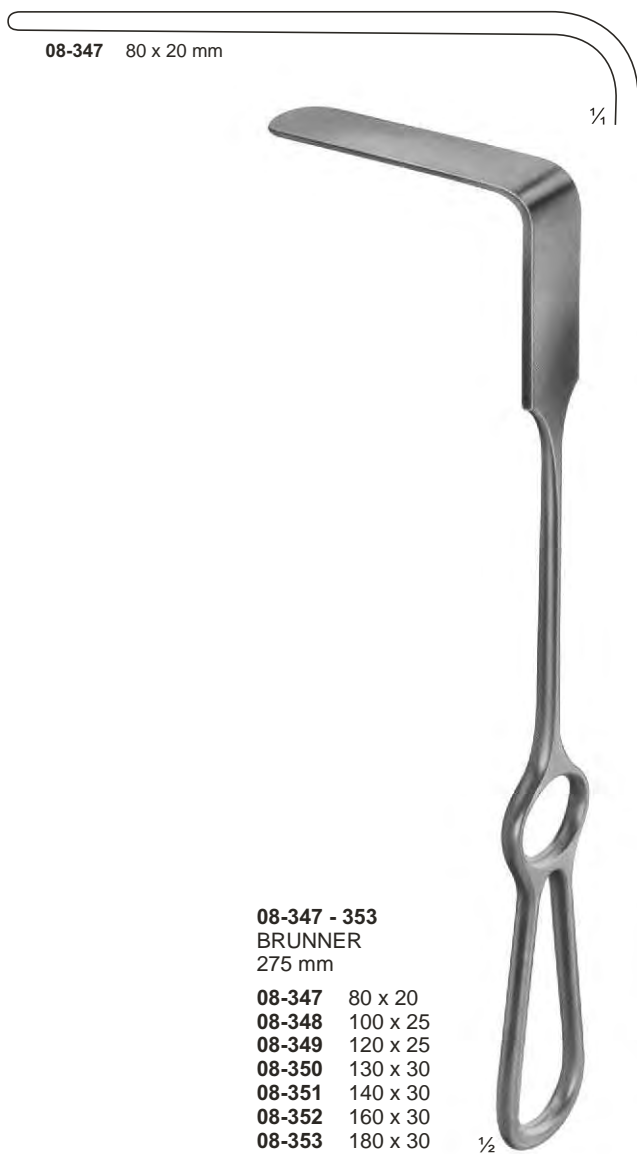

- 08-347 - 353**
BRUNNER
275 mm
- 08-347** 80 x 20
 - 08-348** 100 x 25
 - 08-349** 120 x 25
 - 08-350** 130 x 30
 - 08-351** 140 x 30
 - 08-352** 160 x 30
 - 08-353** 180 x 30



**REALSTAR SURGICAL
INSTRUMENTS**

SERVING TO SAVE LIVES

Retractors, Lung Spatulas

REALSTAR SURGICAL INSTRUMENTS

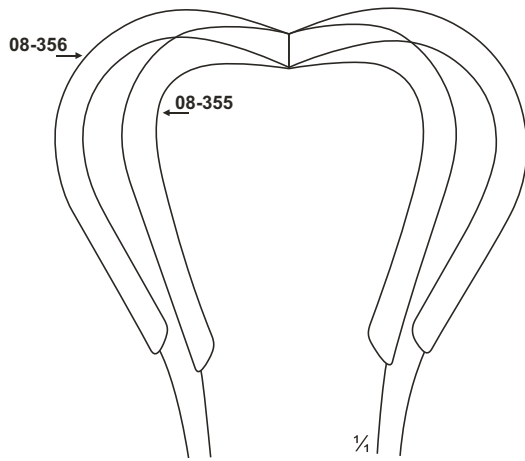

08-355 - 356
HARRINGTON
08-355 123 x 45 mm
08-356 123 x 64 mm
 Flexible
 295 mm



08-357
ALLISON
 255 mm



08-358
ALLISON
 320 mm

Retractors, Lung Spatulas

REALSTAR SURGICAL INSTRUMENTS





08-364
DEAVER
300 mm
Fig. 1

08-365
DEAVER
315 mm
Fig. 2

08-366
DEAVER
365 mm
Fig. 2



08-367
DEAVER
300 mm
Fig. 3

08-368
DEAVER
310 mm
Fig. 4

08-369
DEAVER
320 mm
Fig. 5



08-370
DEAVER
310 mm
Fig. 1

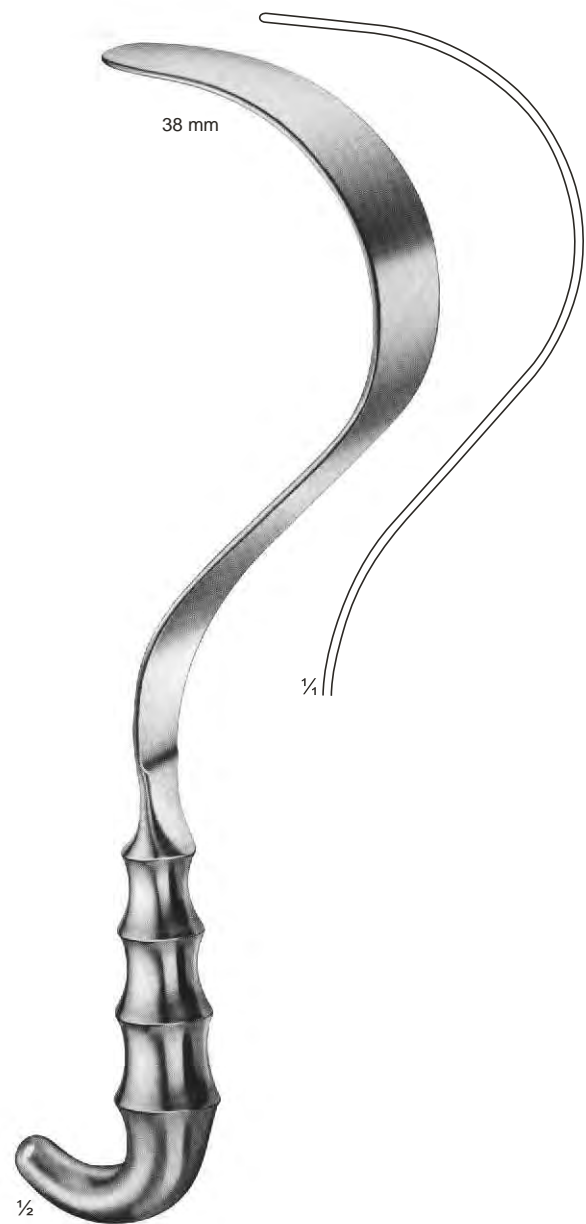

08-371
DEAVER
310 mm
Fig. 3



08-372
DEAVER
305 mm
Fig. 3



08-373
DEAVER
310 mm
Fig. 4

Retractors For Deep Surgery (Abdominal Retractors)

REALSTAR SURGICAL INSTRUMENTS



08-374
MIKULICZ
255 mm

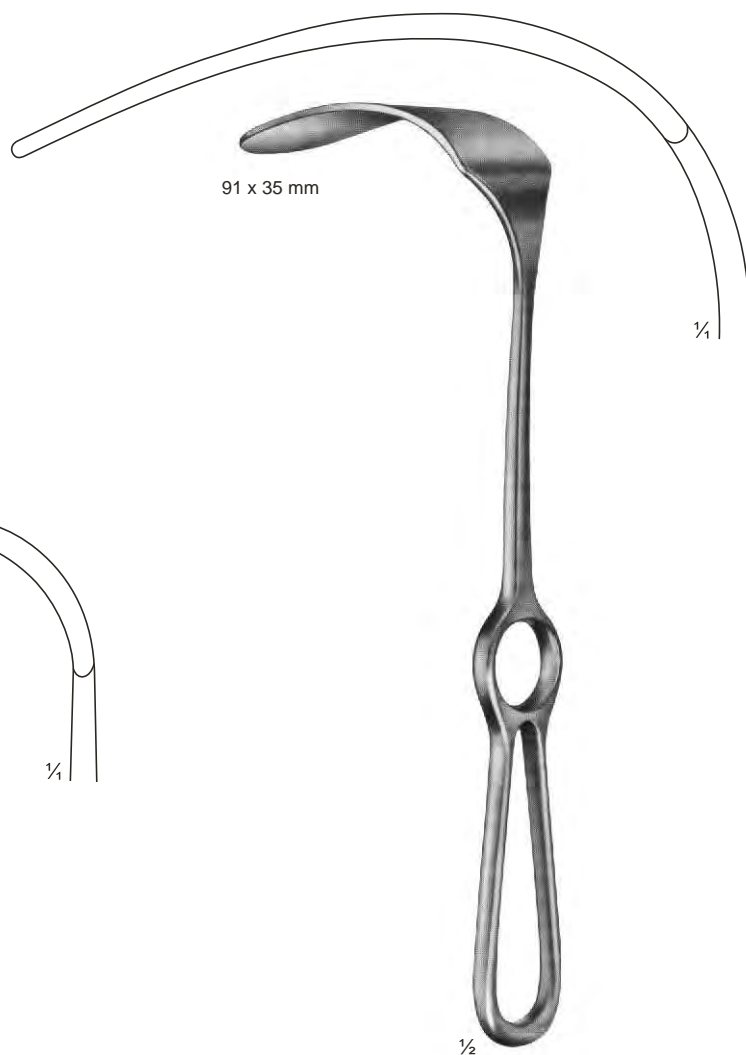

08-375
MIKULICZ
250 mm

Retractors For Deep Surgery (Abdominal Retractors)

REALSTAR SURGICAL INSTRUMENTS

08-378 150 x 39 mm
08-379 150 x 57 mm

08-376 121 x 50 mm
08-377 147 x 50 mm

08-378 - 379
KELLY
08-378 150 x 39 mm
08-379 150 x 57 mm
260 mm

08-376 - 377
MIKULICZ
08-376 121 x 50 mm
08-377 147 x 50 mm
Liver Retractor
250 mm

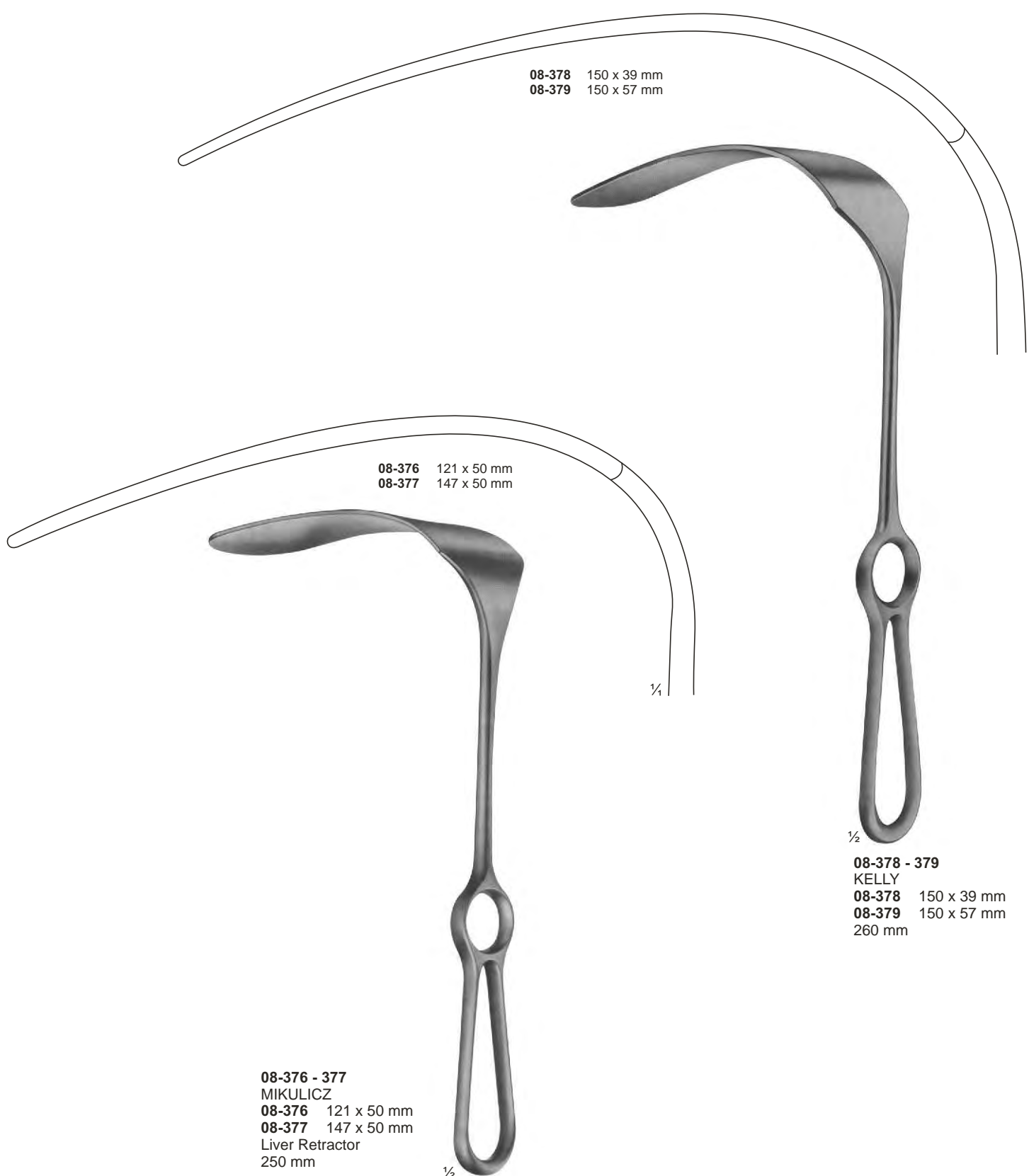

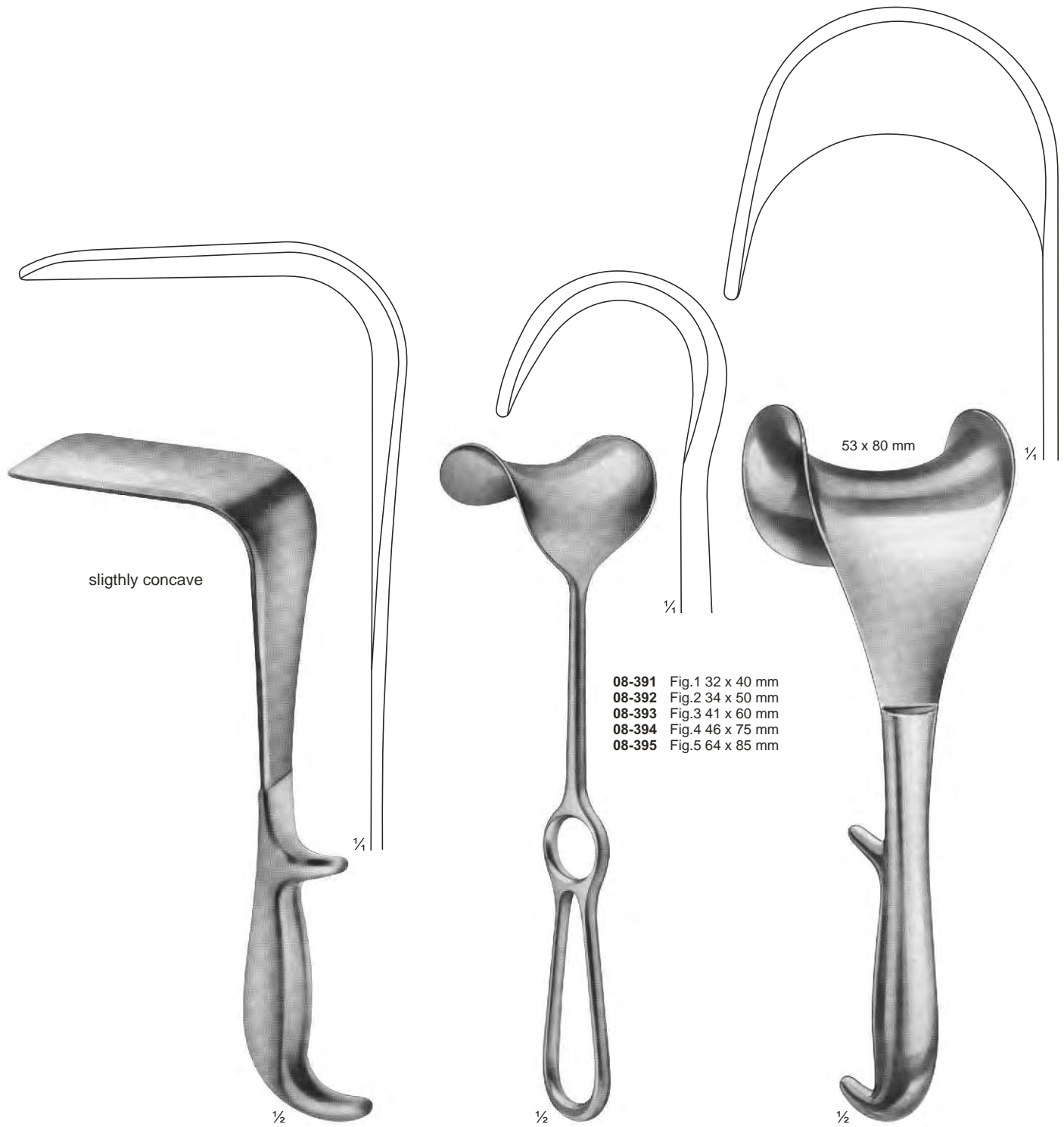

- 08-391 Fig.1 32 x 40 mm
- 08-392 Fig.2 34 x 50 mm
- 08-393 Fig.3 41 x 60 mm
- 08-394 Fig.4 46 x 75 mm
- 08-395 Fig.5 64 x 85 mm

08-380 - 390
DOYEN
240 mm

08-391 - 395
FRITSCH
240 mm

08-396
DOYEN
250 mm

Width of Blades
35 mm, 45 mm, 60 mm

Length of Blades
62 mm 08-380, 08-381, 08-382
92 mm 08-383, 08-384, 08-385
122 mm 08-386, 08-387, 08-388
160 mm 08-389, 08-390

Abdominal Retractors

REALSTAR SURGICAL INSTRUMENTS



08-397 - 401
ROCHARD
 310 mm
08-397 48 x 90 mm
08-398 48 x 105 mm
08-399 48 x 120 mm
08-400 48 x 135 mm
08-401 48 x 155 mm



08-402



08-403 - 406
DOYEN
 280 mm
08-403 48 x 90 mm
08-404 48 x 105 mm
08-405 48 x 120 mm
08-406 48 x 135 mm



08-407
DOYEN-CHILD
 Fixation device
 220 mm



08-408
 Chain with
 weight (747 / 645g)
 790 mm

Pelvis Retractors

REALSTAR SURGICAL INSTRUMENTS

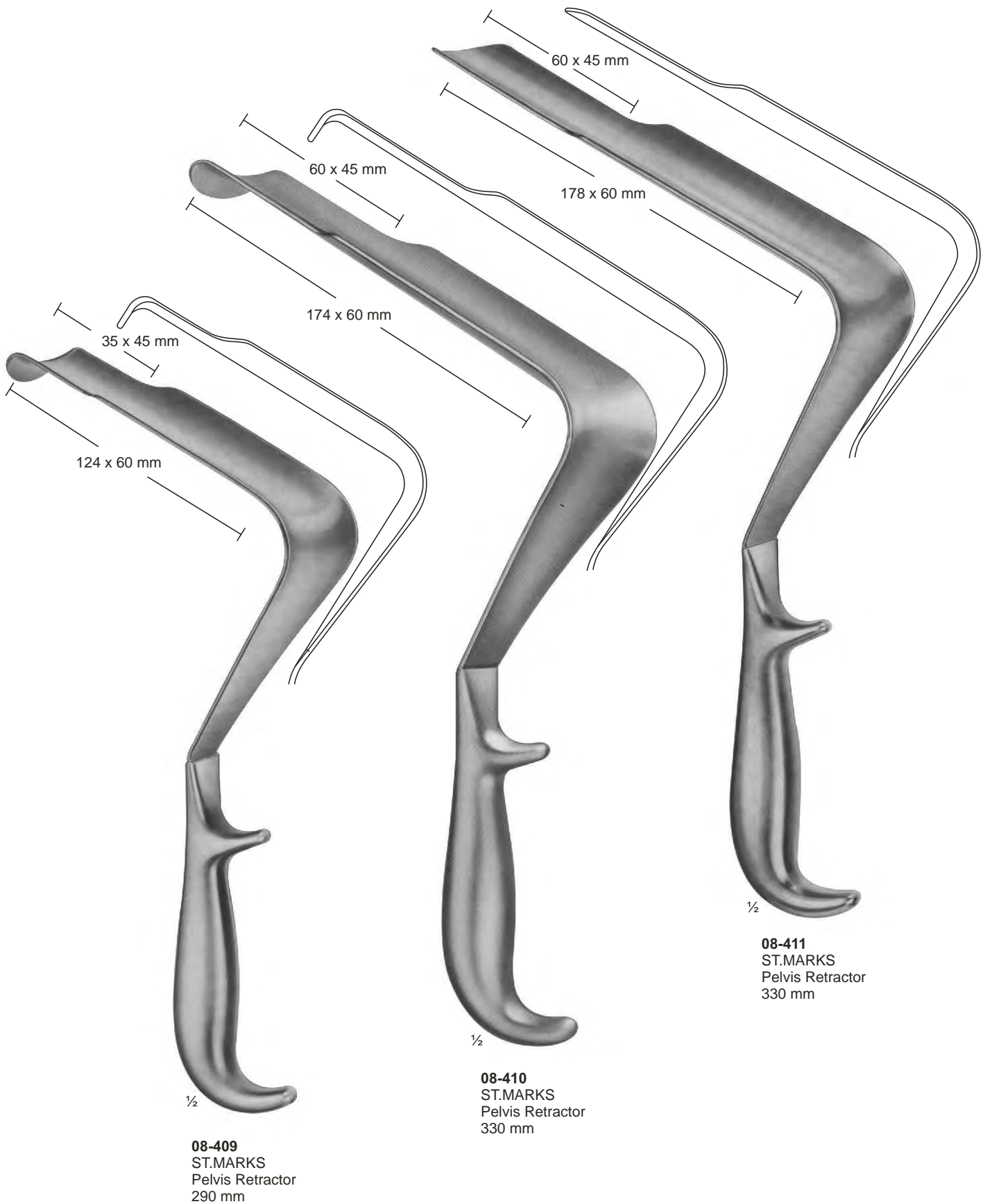

Abdominal- and Intestinal Spatulas

REALSTAR SURGICAL INSTRUMENTS



08-412
LERICHE
255 mm

08-413
KUMMEL
Melleable
285 mm

08-414
MIKULICZ
29 mm
250 mm

08-415 - 416
KADER
08-415 30 mm
08-416 40 mm
270 mm

Abdominal- and Intestinal Spatulas

REALSTAR SURGICAL INSTRUMENTS



08-417
REVERDIN
285 mm



08-418
HABERER
Malleable
305 mm



08-419 30 mm
08-420 40 mm
08-421 50 mm
Malleable
330 mm



08-422
TUFFIER
Malleable
200 mm

Self-Retaining Retractors

REALSTAR SURGICAL INSTRUMENTS



08-423
BOSE
60 mm



08-424
FINSEN
50 mm



08-425
FINSEN
70 mm



08-426
FINSEN modif.
75 mm



08-427
45 mm



08-428
55 mm



08-429
MUELLER
65 mm



08-430
100 mm



08-431



08-432



08-431 - 432
ALM
08-431 70 mm
08-432 100 mm

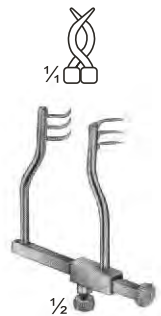

08-433
LOGAN
modif. REILL
50 mm

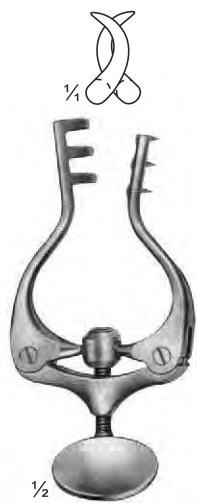

08-434
JANSEN
100 mm



08-435
JANSEN
100 mm

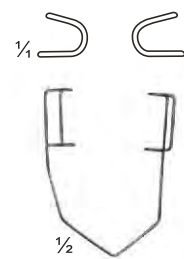

08-436
BARRAQUER
45 mm

Self-Retaining Retractors

REALSTAR SURGICAL INSTRUMENTS



08-437
WEITLANER
Sharp
110 mm

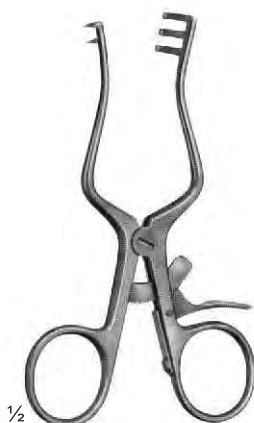

08-438
WEITLANER
Semi-Sharp
110 mm



08-439
WEITLANER
Blunt
110 mm



08-440
WEITLANER
Sharp
130 mm



08-441
WEITLANER
Semi-Sharp
130 mm



08-442
WEITLANER
Blunt
130 mm

Self-Retaining Retractors

REALSTAR SURGICAL INSTRUMENTS

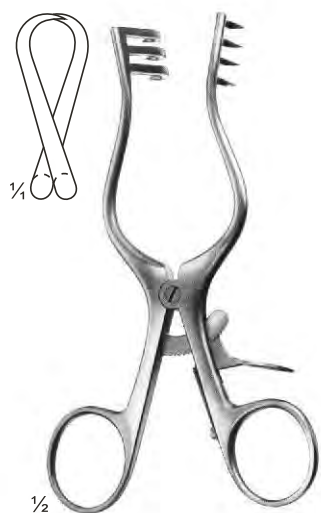

08-443
WEITLANER
Sharp
130 mm

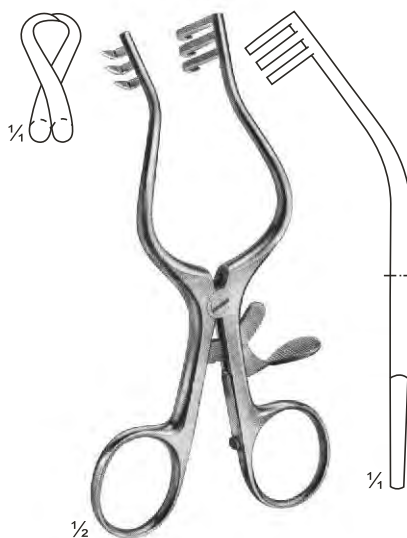

08-444
WULLSTEIN
Sharp
130 mm

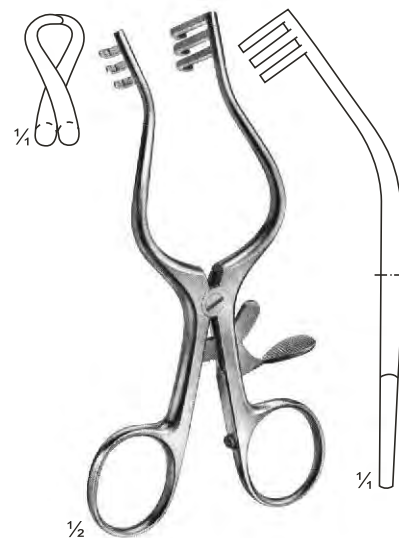

08-445
WULLSTEIN
Blunt
130 mm

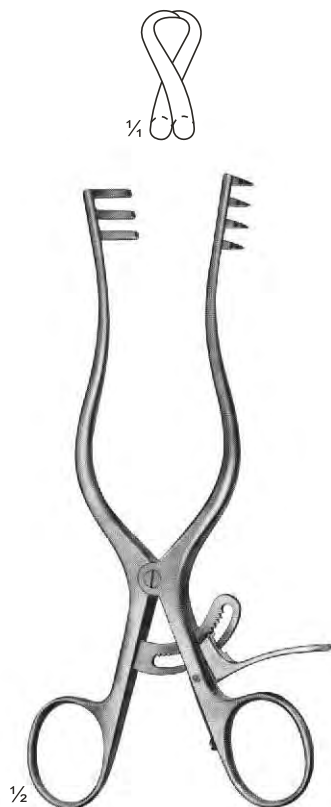

08-446
WEITLANER
Sharp
165 mm



08-447
PLESTER
Blunt
110 mm

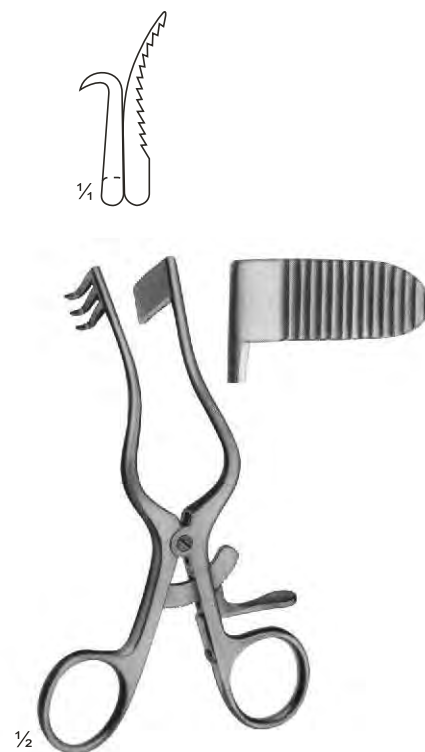

08-448
PERKINS
130 mm

Self-Retaining Retractors

REALSTAR SURGICAL INSTRUMENTS



08-449
ADSON-BABY
Blunt
140 mm

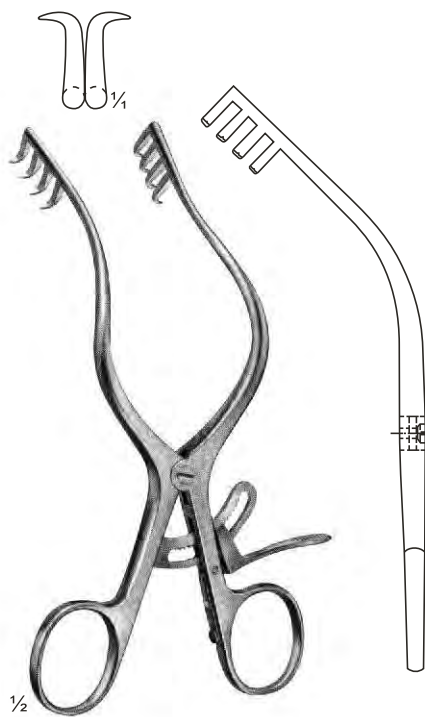

08-450
MOLLISON
Sharp
155 mm



08-451
MAYO-ADAMS
165 mm

Self-Retaining Laminectomy Retractors

REALSTAR SURGICAL INSTRUMENTS

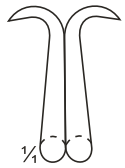

08-452
ANDERSON-ADSON
Sharp
190 mm



08-453
NORFOLK and
NORWICH
Blunt
220 mm



08-454
ADSON
Sharp
265 mm

Self-Retaining Laminectomy Retractors

REALSTAR SURGICAL INSTRUMENTS

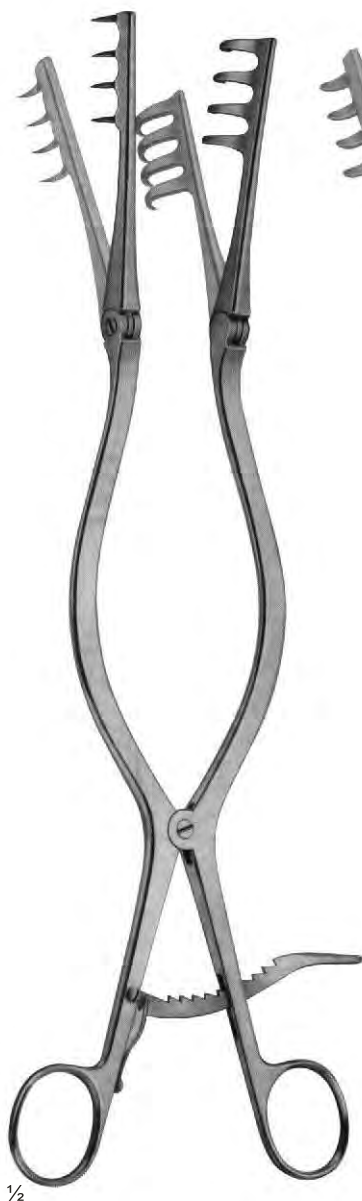
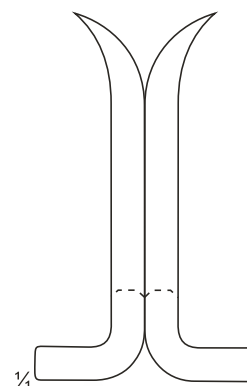
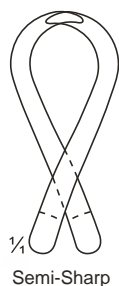
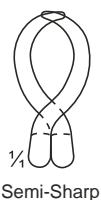

08-455 - 456
BECKMANN-ADSON
Sharp
310 mm



08-456
BECKMANN-ADSON
Semi-Sharp
310 mm



08-457
ADSON
Semi-Sharp
320 mm



08-458
BECKMANN-EATON
Sharp
320 mm

Special Retractors

REALSTAR SURGICAL INSTRUMENTS



08-459
JOLL (FRIEDMAN)
 Thyroid- and Vaginal Retractor
 155 mm

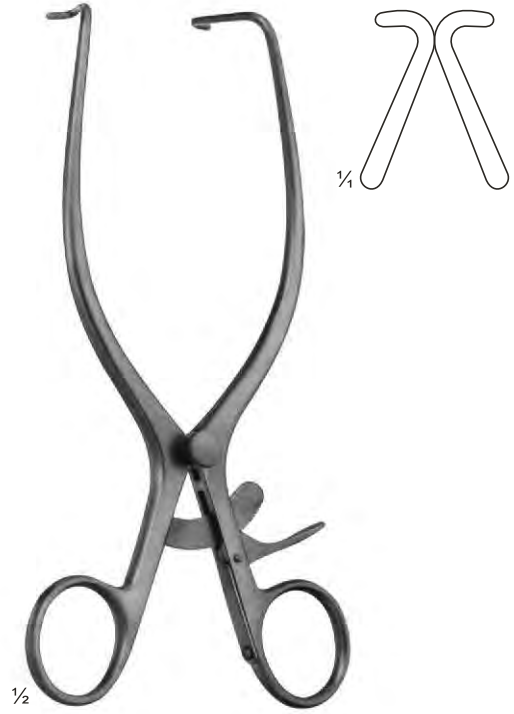

08-460
JACKSON BURROWS
 Retractor, blunt
 185 mm

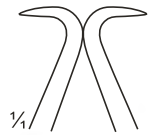

08-461
GELPI
 Vaginal Retractor
 135 mm

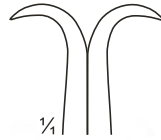

08-462
GELPI
 Skin- and Vaginal Retractor
 175 mm

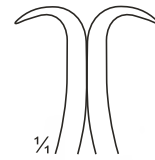

08-463
DE BAKEY
 Femur Retractor
 145 mm

Self Retaining Retractors for Laminectomy and other Operations

REALSTAR SURGICAL INSTRUMENTS

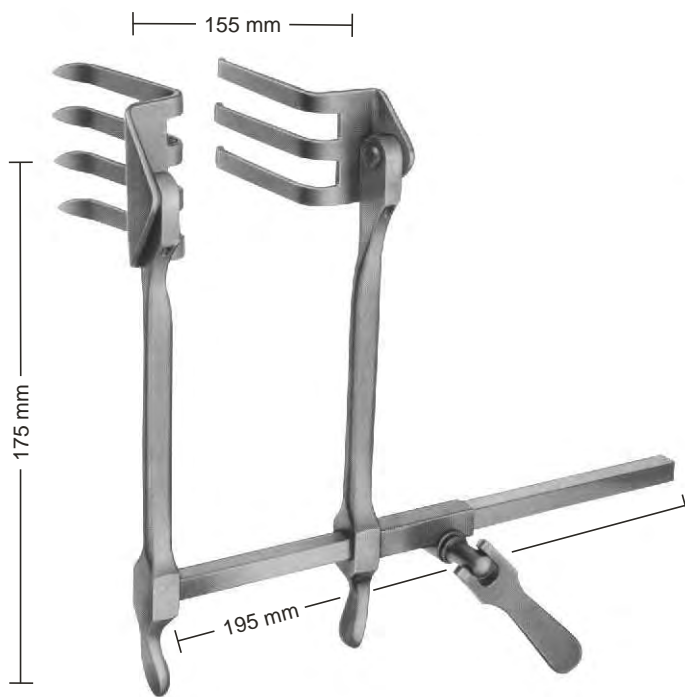

08-464 - 468
 SCOVILLE-RICHTER
 Retractor with 1 pair
 blades reversible type.
 The Retractor bar and
 shanks may be easily
 rotated 180° when
 blades are in situ.



08-465
 62 x 52 mm 62 x 37 mm
 PR= Pair



08-466
 47 x 51 mm



08-467
 30 x 40 mm



08-468
 37 x 62 mm

Retractors for Cervical Spine

REALSTAR SURGICAL INSTRUMENTS



08-469
CLOWARD modif.
Spreader Only



40 mm
16 mm
08-470



45 mm
16 mm
08-471



40 mm
16 mm
08-475



45 mm
16 mm
08-476

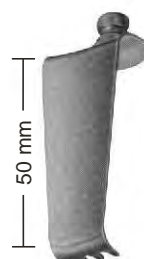

50 mm
16 mm
08-472

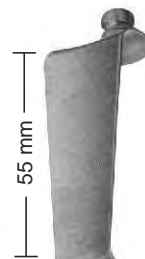

55 mm
16 mm
08-473

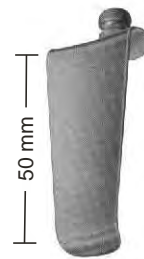

50 mm
16 mm
08-477



55 mm
16 mm
08-478

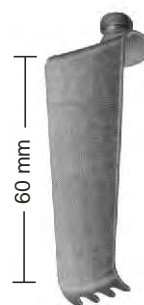

60 mm
16 mm
08-474



60 mm
16 mm
08-479

- 08-470 blade
- 08-471 blade
- 08-472 blade
- 08-473 blade
- 08-474 blade

- 08-475 blade
- 08-476 blade
- 08-477 blade
- 08-478 blade
- 08-479 blade

Retractors for Cervical Vertebral Column

REALSTAR SURGICAL INSTRUMENTS

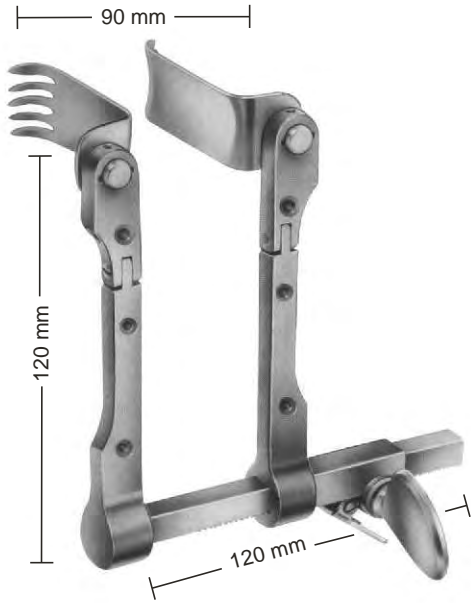

08-480
CASPAR
Retractor, adjustable,
consisting of: 5 medial
blades, 5 Lateral blades.

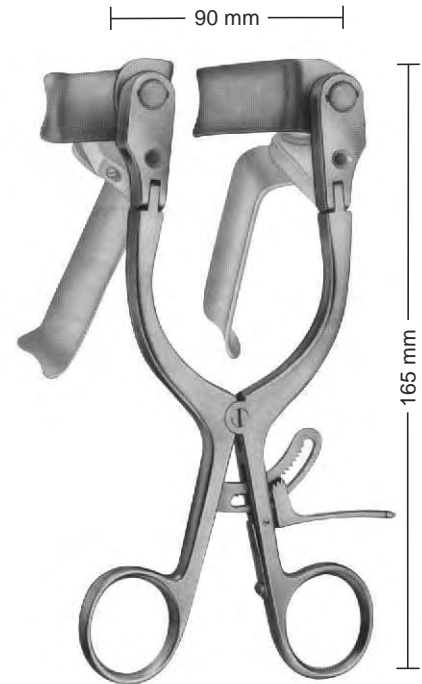

08-480 A
CASPAR
Counter retractor, adjustable,
consisting of: 5 blades.



08-481 40 x 23 mm
08-482 45 x 23 mm
08-483 50 x 23 mm
08-484 55 x 23 mm
08-485 60 x 23 mm
Medial blades



08-486 40 x 23 mm
08-487 45 x 23 mm
08-488 50 x 23 mm
08-489 55 x 23 mm
08-490 60 x 23 mm
Lateral blades



08-491 45 x 23 mm
08-492 50 x 23 mm
08-493 55 x 23 mm
08-494 60 x 23 mm
08-495 65 x 23 mm
Blunt blades



08-496 50 x 25 mm
08-497 60 x 25 mm
Blunt blades,
for harvesting of the
fusion graft from the
iliac crest



08-498 40 x 25 mm
08-499 45 x 25 mm
08-500 50 x 25 mm
08-501 55 x 25 mm
08-502 60 x 25 mm
Medial Titan blades
semi transparent to x-ray



08-503 40 x 25 mm
08-504 45 x 25 mm
08-505 50 x 25 mm
08-506 55 x 25 mm
08-507 60 x 25 mm
Lateral Titan blades
semi transparent to x-ray

Lamina Spreaders

REALSTAR SURGICAL INSTRUMENTS

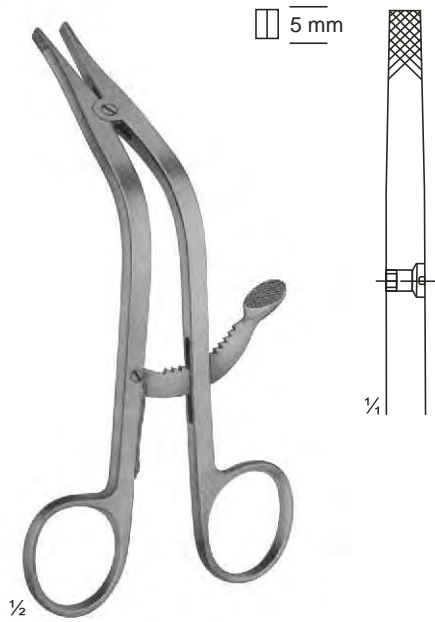

08-508
CLOWARD
155 mm



08-509
CLOWARD
135 mm

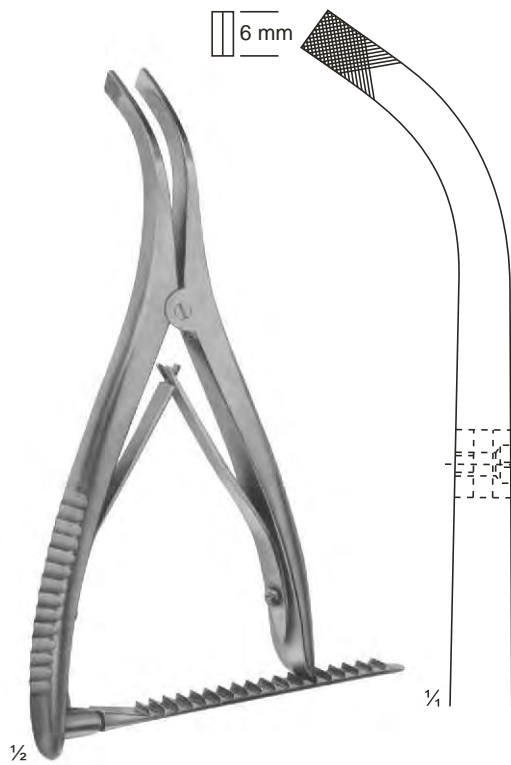

08-510
INGE
170 mm

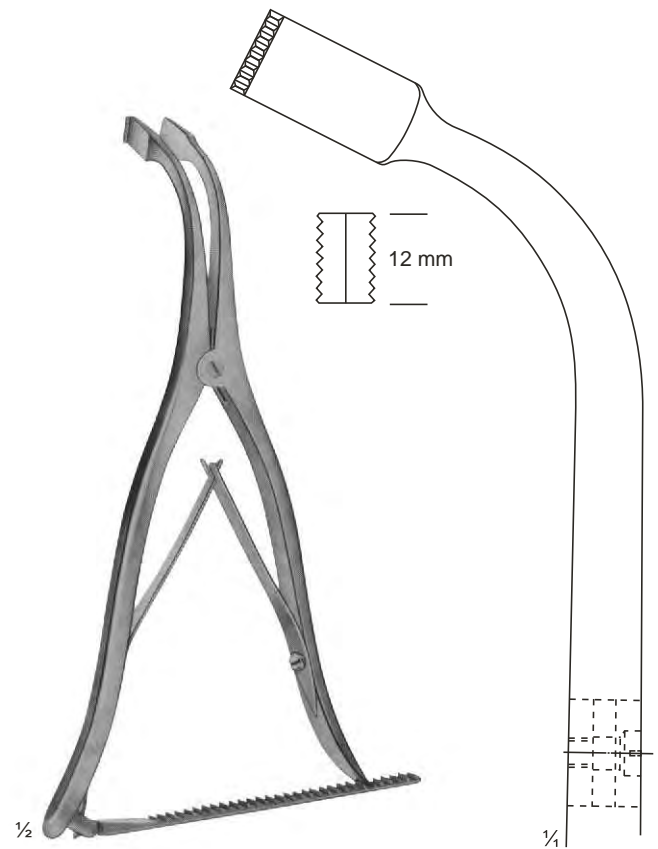

08-511
INGE
275 mm

Abdominal Retractors

REALSTAR SURGICAL INSTRUMENTS



08-512
BABY-COLLIN
with 2 pair of blades

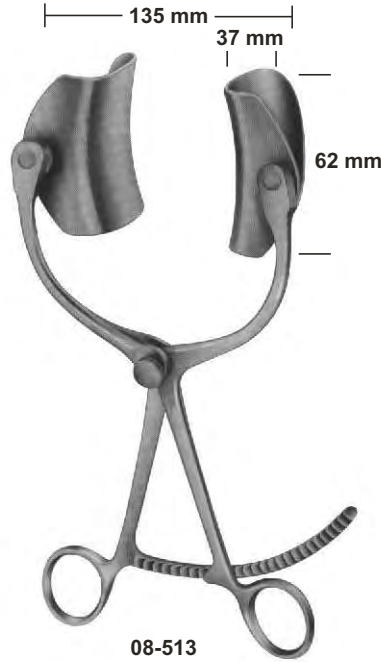

08-513
COLLIN
complete

08-817 135 mm
08-818 160 mm



08-516 37x98mm
08-515 37x80mm
08-514 37x62mm
08-518 54x55mm

08-514 - 518
COLLIN
complete



08-519 - 520
RICARD
complete

Spreader only **08-519** **08-520**
Lateral blade 58x80mm 72x84mm
Canter blade 54x70mm 72x90mm



08-521 - 523
HOLZBACH
Complete

08-521 Spreader only
08-522 Lateral blade 59x80mm
08-523 Canter blade 74x82mm

Abdominal Baldes

REALSTAR SURGICAL INSTRUMENTS

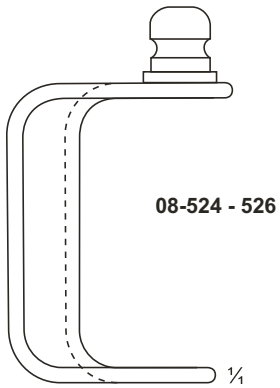

Lateral blades only
08-524 37x62 mm
08-525 37x80 mm
08-526 37x98 mm

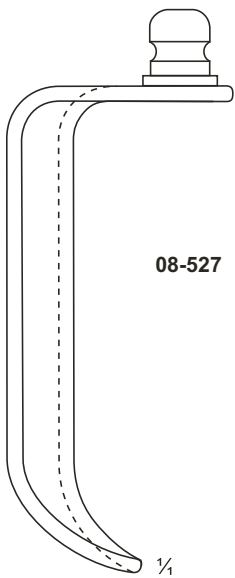

08-527 61x80 mm

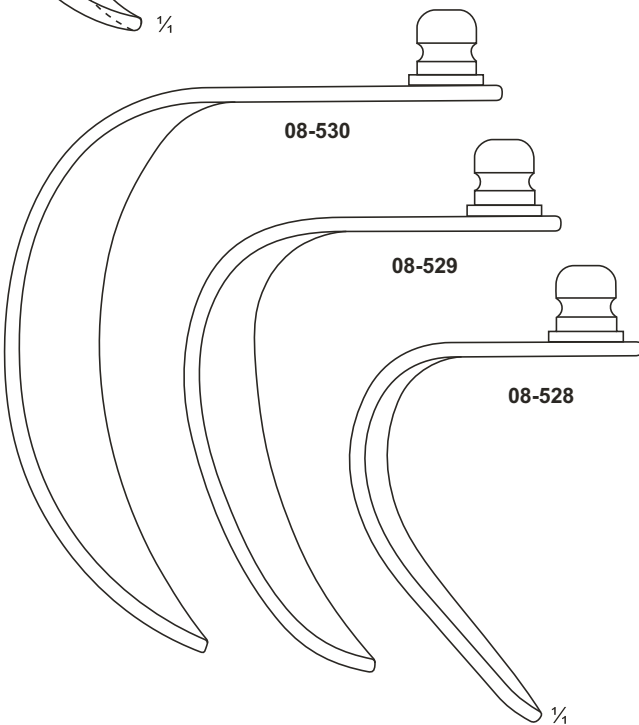

08-528 48x59 mm
08-529 58x80 mm
08-530 72x84 mm

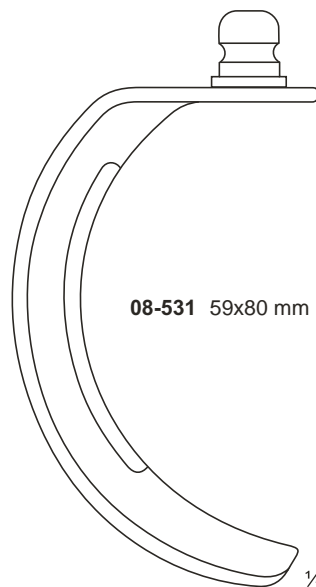

08-531 59x80 mm



Abdominal Retractors

REALSTAR SURGICAL INSTRUMENTS

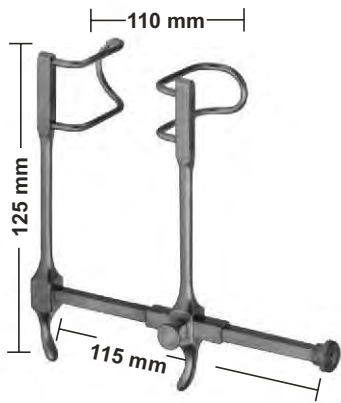

08-532
GOSSET
Blades:38 mm deep

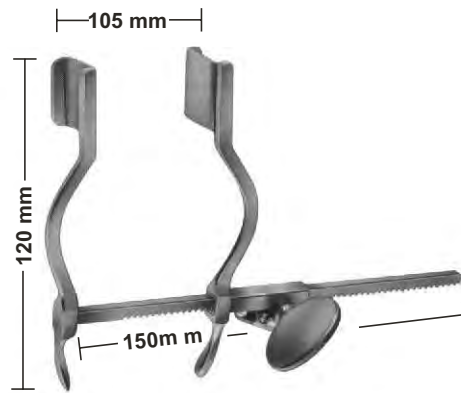

08-533
HERTZLER
Blades 20 X 25 mm

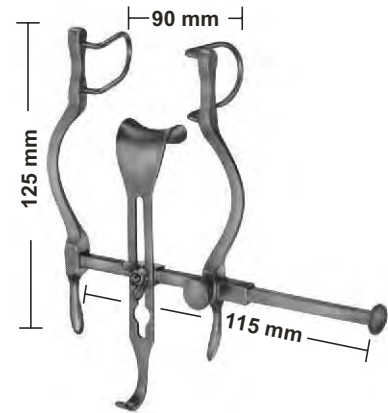

08-534
BALFOUR-BABY
Lateral blades 27 mm deep
Center blade 21x24 mm

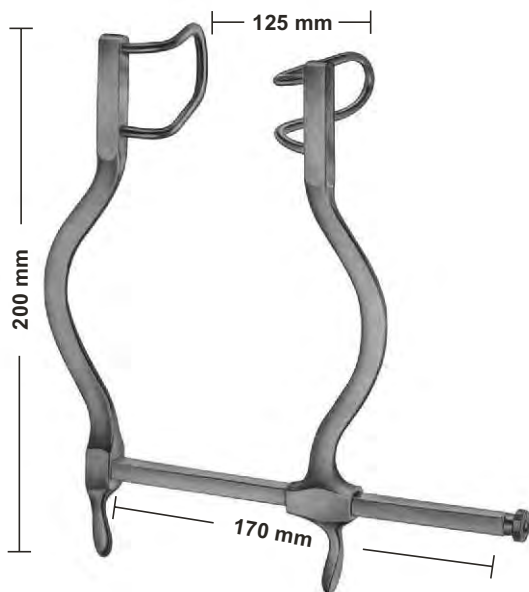

08-535
GOSSET
Blades:55mm deep

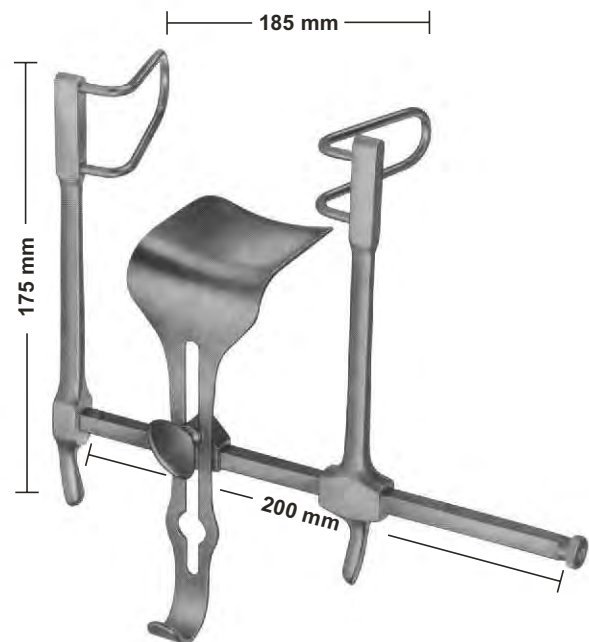

08-536
GOSSET
Lateral blades 58 mm deep
Center blade 59 x 57 mm

Abdominal Retractors

REALSTAR SURGICAL INSTRUMENTS

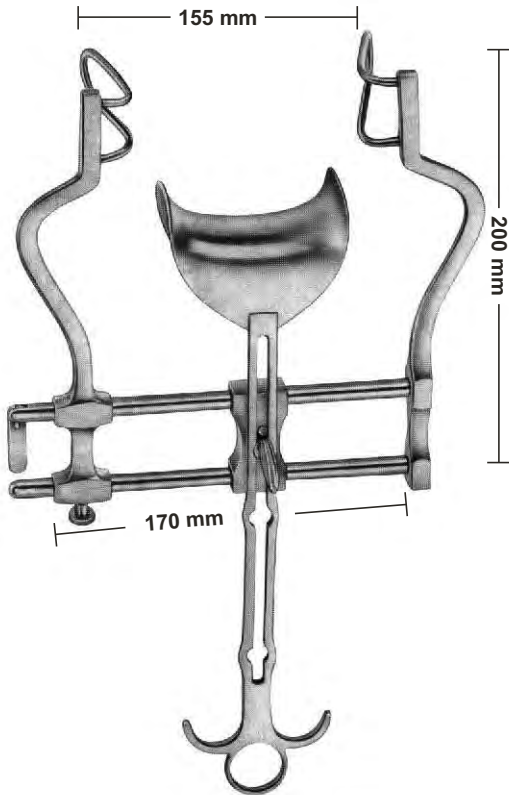

08-537
BALFOUR
Lateral blades 60 mm deep
Center blade 47 x 80 mm

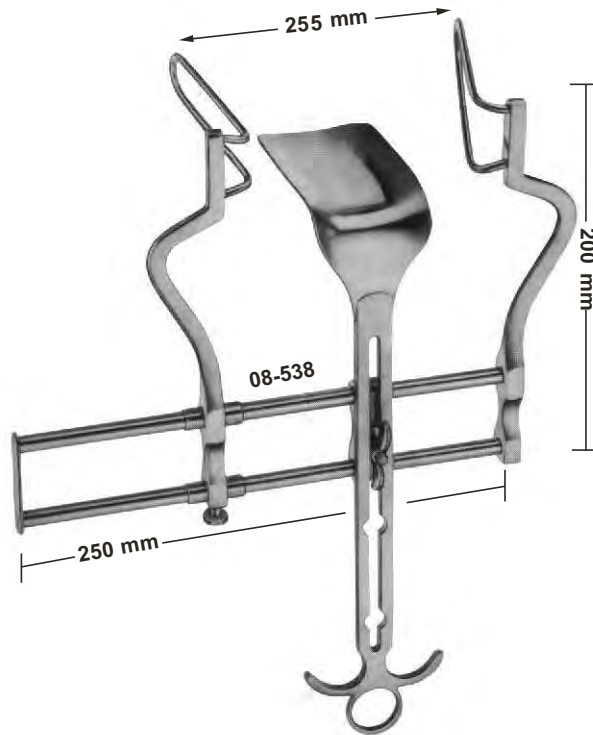

08-538
BALFOUR
Lateral blades 105 mm deep
Center blade 107x 59 mm

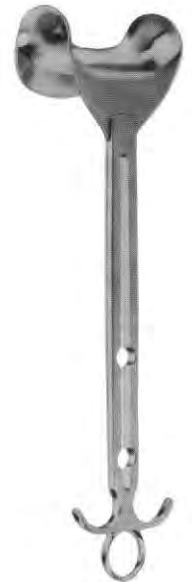

08-539
Center blade only
54x80 mm

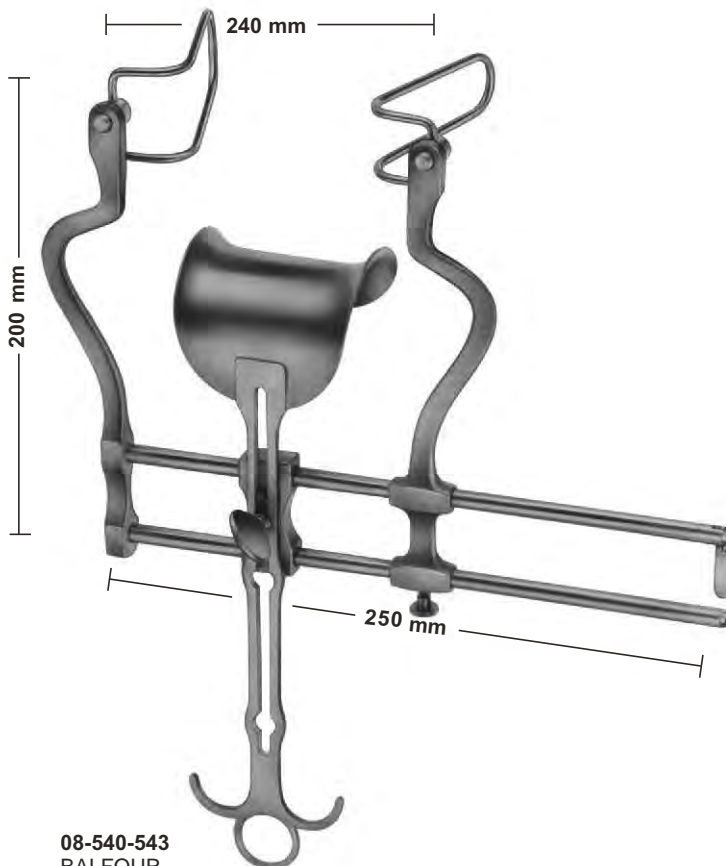

08-540-543
BALFOUR
Spreader only
Lateral blades 50 mm
Center blade 47 x 80 mm

08-540	08-541	08-542	08-543
Lateral blades 50 mm	60 mm	75 mm	90 mm
Center blade 47 x 80 mm	62x76 mm	80x80 mm	80x80 mm



Lateral blades
08-544 50 mm deep
08-545 60 mm deep
08-546 75 mm deep
08-547 90 mm deep
Sales Unit of blades: PR = pair

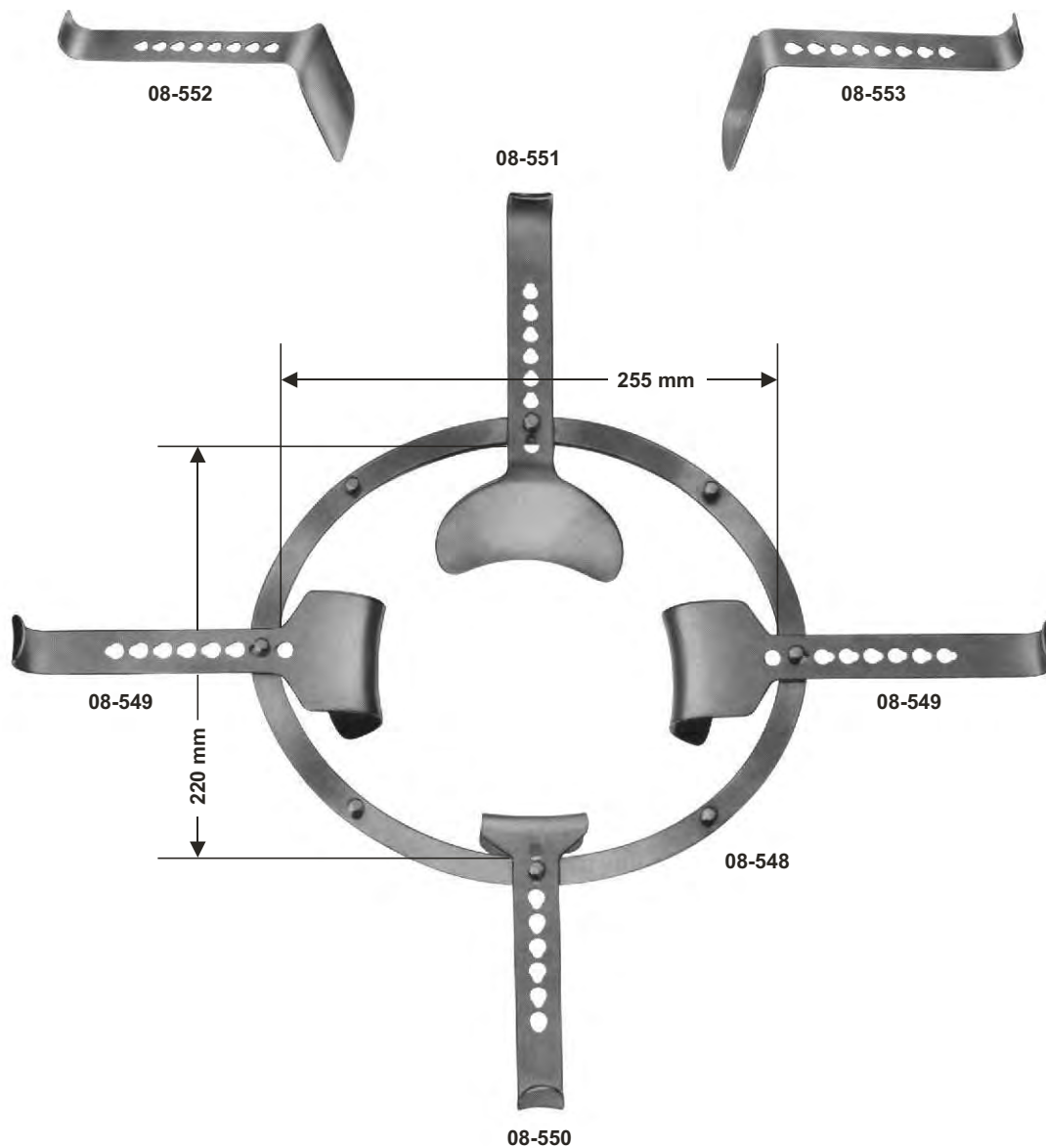

08-548 - 08-553

SEMM

consisting of:

- 08-548** 1 frame 225 x 220 mm
- 08-549** 2 blades 46 x 64 mm
- 08-550** 1 blade 53 x 54 mm
(for bladder)
- 08-551** 1 blade 82 x 97 mm
(for intestine)
- 08-552** 1 blade 98 x 51 mm
(for intestine)
- 08-553** 1 blade, narrow
107 x 36 mm

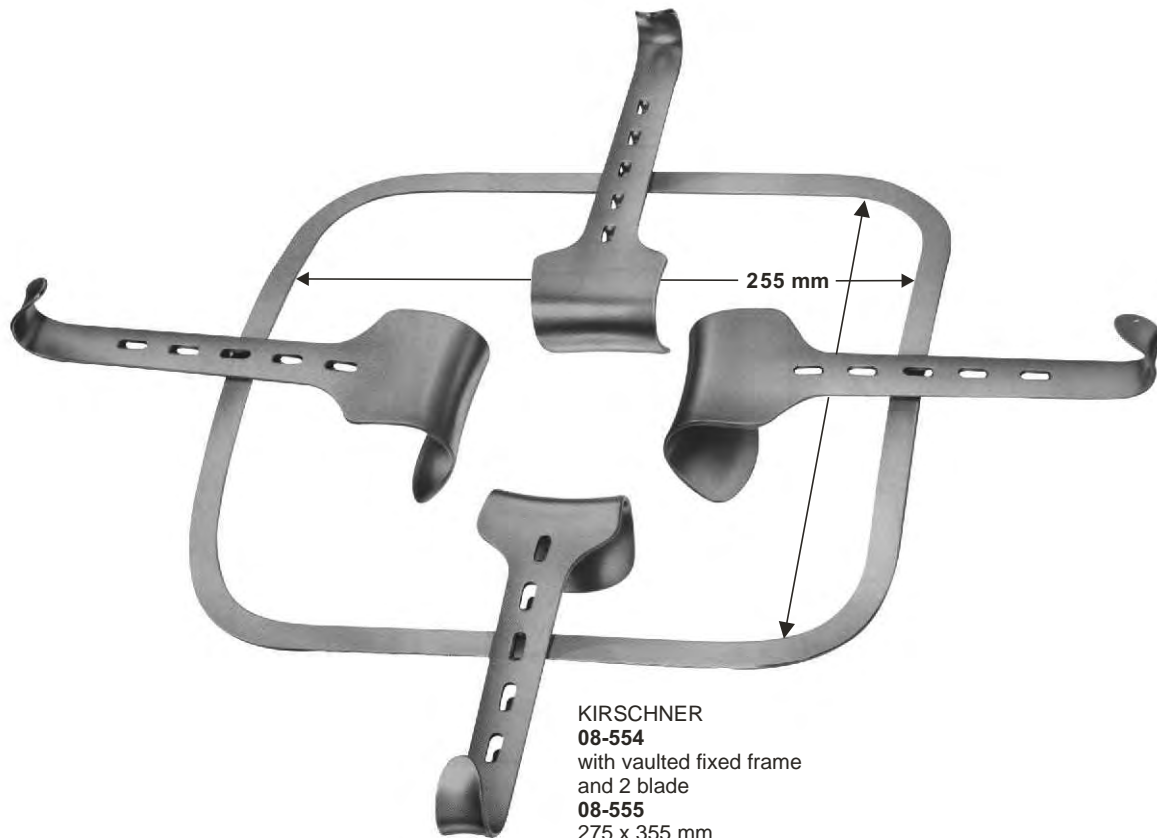

KIRSCHNER
08-554
with vaulted fixed frame
and 2 blade
08-555
275 x 355 mm
Frame only, over-sized
08-556
295 x 275 mm
Frame only



08-557
KIRSCHNER
64 x 80 mm



08-558
KIRSCHNER-BALFOUR
80x 82 mm



08-559 - 561
KIRSCHNER
08-559 90x 69mm
08-560 92x 95mm
08-561 78x 58mm



08-562 - 564
KIRSCHNER
08-562 108x42mm
08-563 91x 55mm
08-564 121x 55mm

Intestinal and Tissue Grasping Forceps

REALSTAR SURGICAL INSTRUMENTS

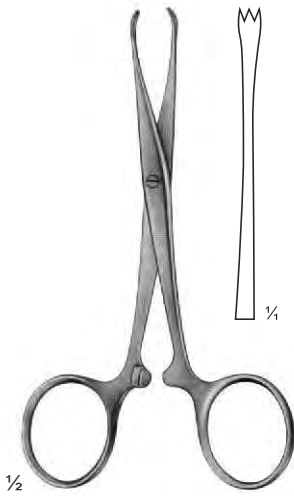

09-101
CHAPUT
 2 X 3 teeth, sharp
 125 mm,

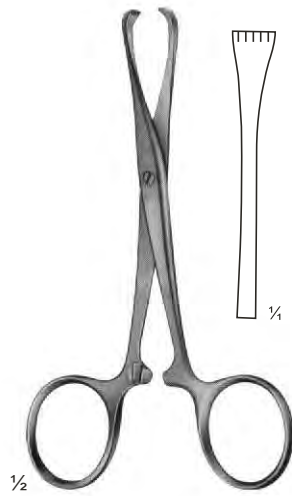

09-102
TUFFIER
 5 X 6 teeth, sharp
 125 mm,



09-103
BOYS-ALLIS
 5 X 6 teeth, sharp
 155 mm,

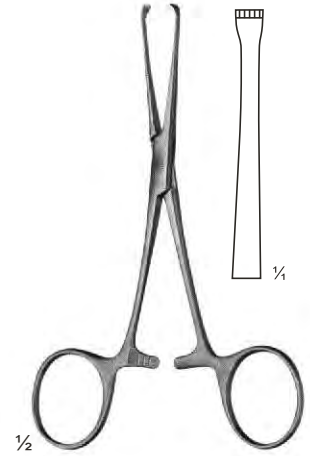

09-104
ALLIS
 4 X 5 teeth
 155 mm,

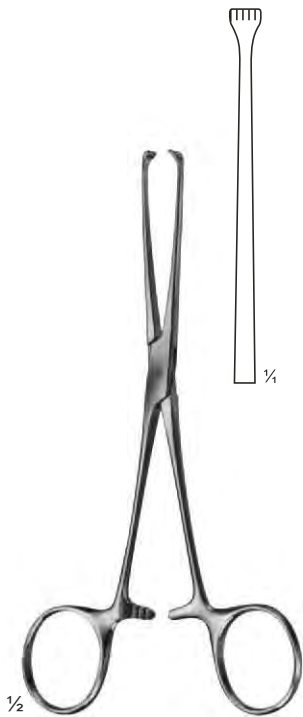

09-105
ALLIS
 155 mm,
 4 X 5 teeth

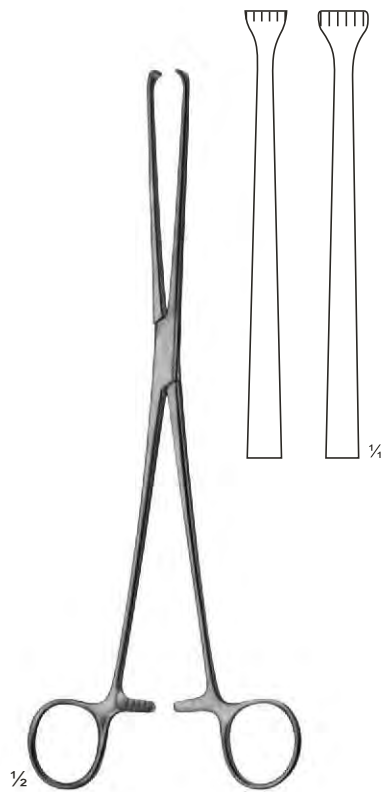

09-106
ALLIS
 190 mm,
09-107
 255 mm,
 5 X 6 teeth

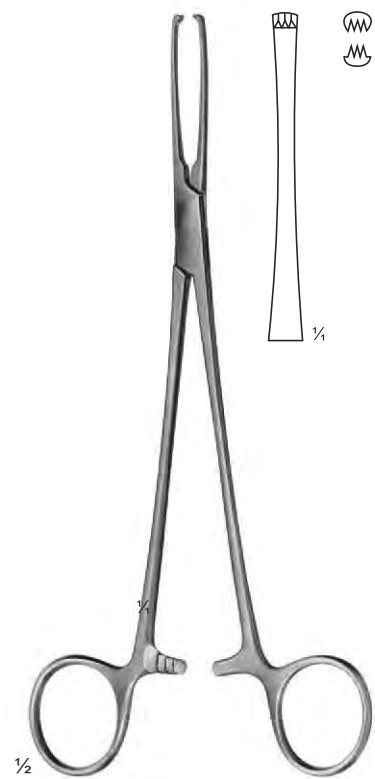

09-108
JUDD-ALLIS
 3 X 4 teeth
 195 mm,

Intestinal Grasping Forceps

REALSTAR SURGICAL INSTRUMENTS

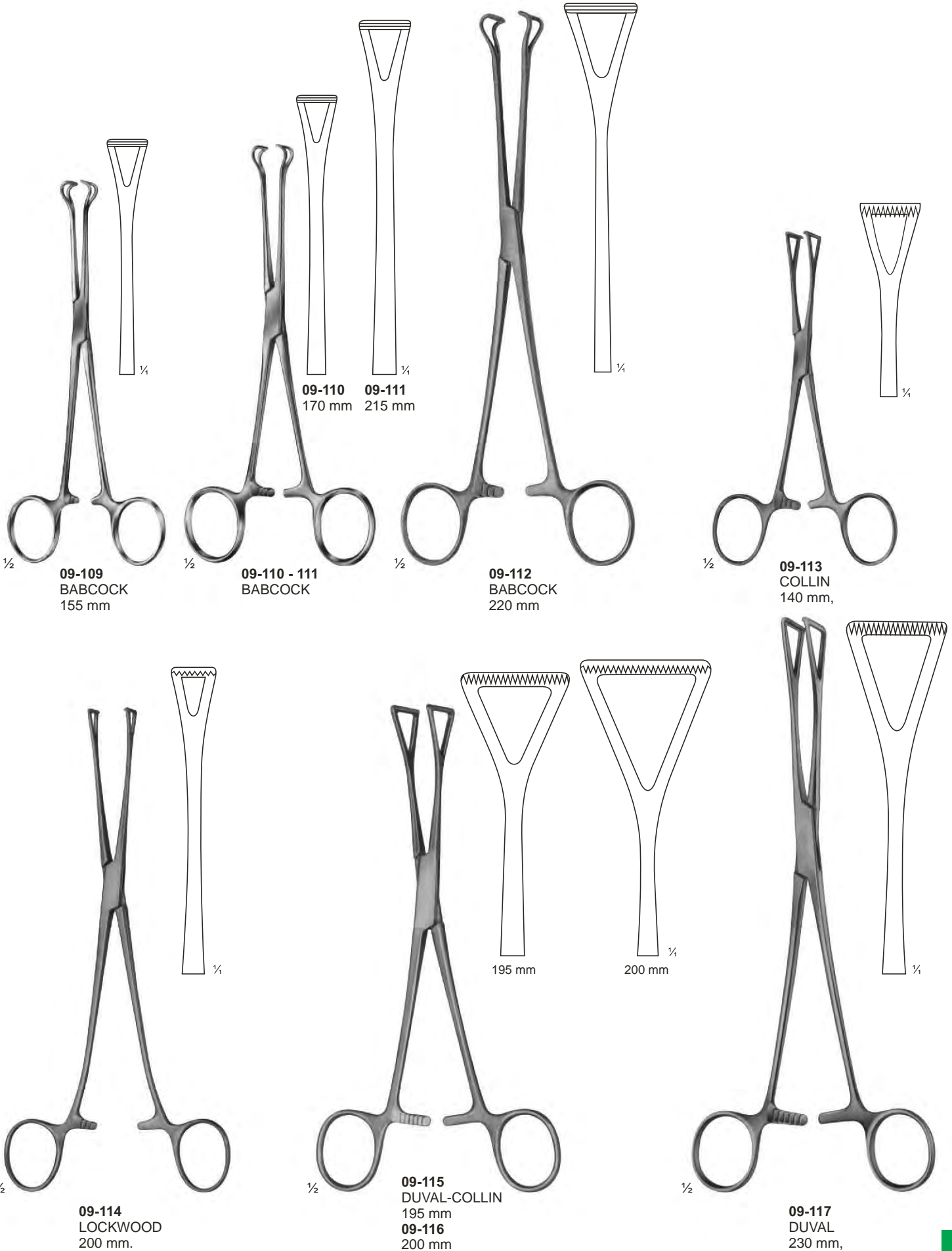

09-109
BABCOCK
155 mm

09-110 - 111
BABCOCK

09-110 170 mm
09-111 215 mm

09-112
BABCOCK
220 mm

09-113
COLLIN
140 mm,

09-114
LOCKWOOD
200 mm.

09-115
DUVAL-COLLIN
195 mm
09-116
200 mm

09-117
DUVAL
230 mm,

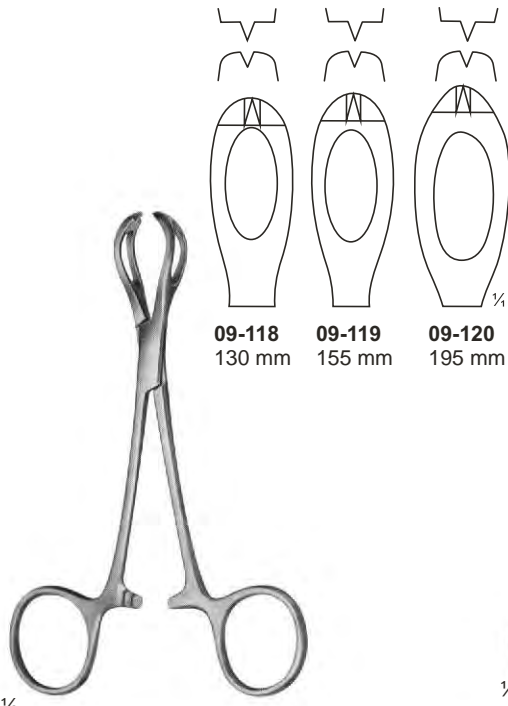

09-118-120
LANE

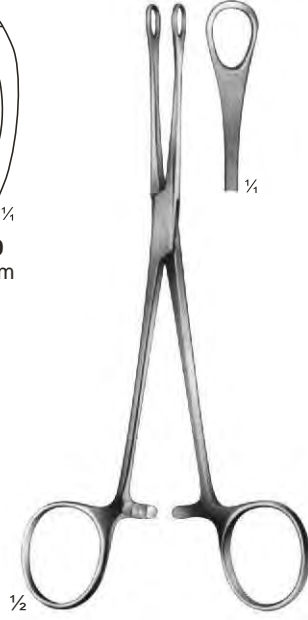

09-121
WILLIAMS
160 mm



09-122
DENIS
BROWNE
190 mm



09-123
DUVAL
140 mm



09-124 09-125
DUROGRIP
09-124
WANGENSTEEN
150 mm
09-125
WANGENSTEEN
230 mm



09-126
WANGENSTEEN
150 mm
09-127
WANGENSTEEN
230 mm

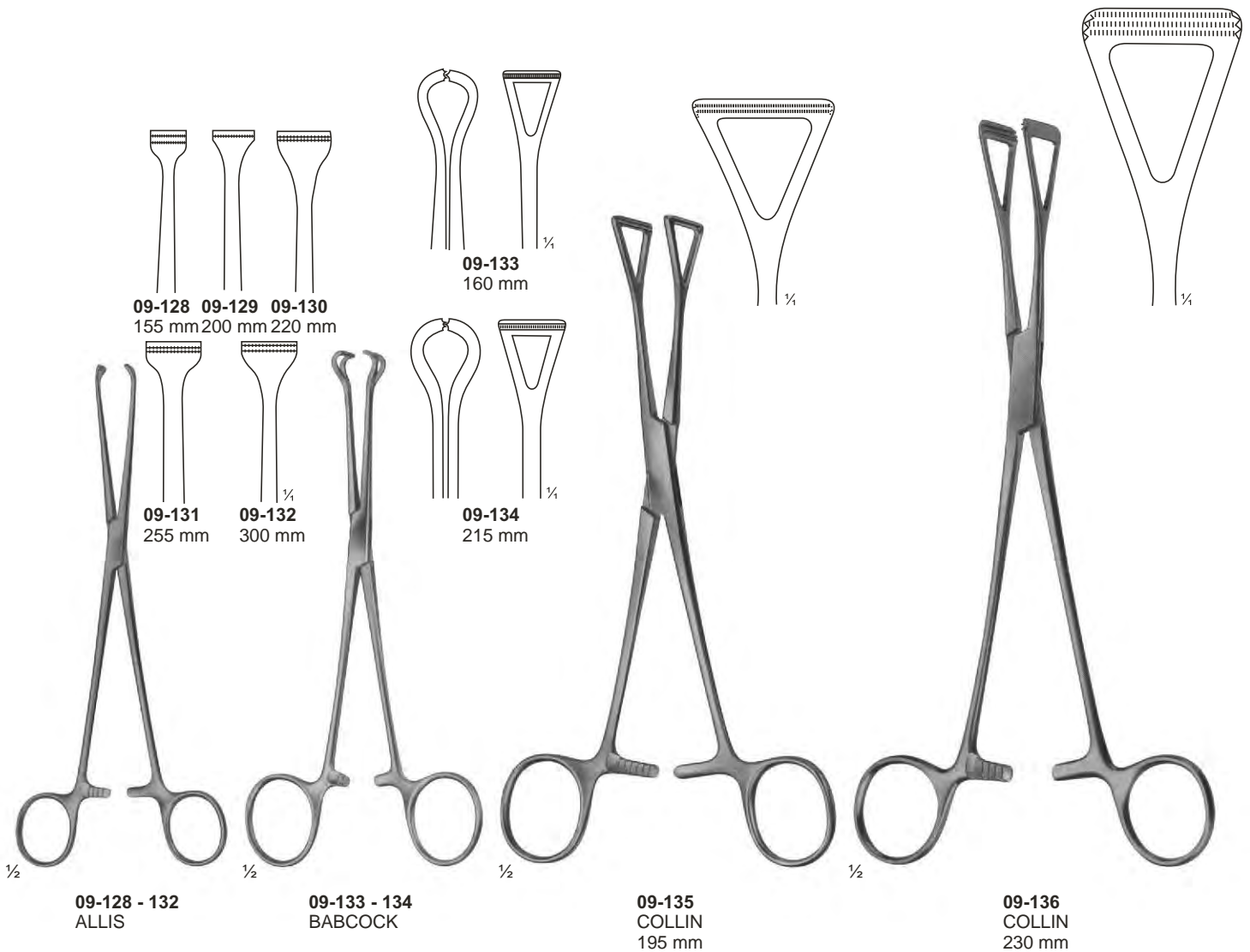

Ultra - Light - Forceps, Dissecting Forceps

REALSTAR SURGICAL INSTRUMENTS

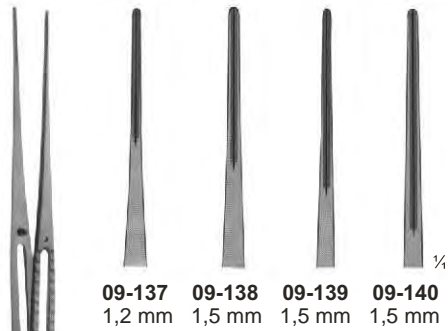

1/2

- 09-137** 150 mm
- 09-138** 200 mm
- 09-139** 240 mm
- 09-140** 300 mm



1/2

- DE BAKEY**
- 09-141** 150 mm
 - 09-142** 200 mm
 - 09-143** 240 mm
 - 09-144** 300 mm

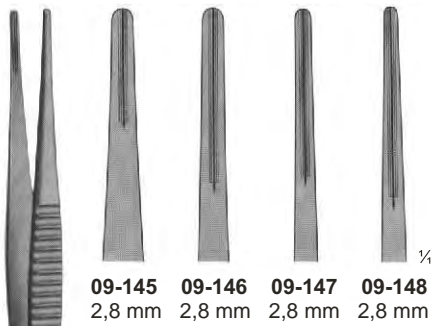

1/2

- DE BAKEY**
- 09-145** 150 mm
 - 09-146** 200 mm
 - 09-147** 240 mm
 - 09-148** 300 mm

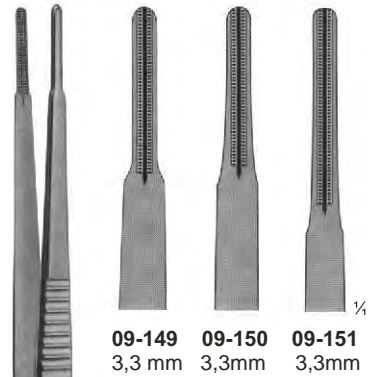

1/2

- DE BAKEY**
- 09-149** 200 mm
 - 09-150** 240 mm
 - 09-151** 300 mm

Intestinal Clamps for Children

REALSTAR SURGICAL INSTRUMENTS

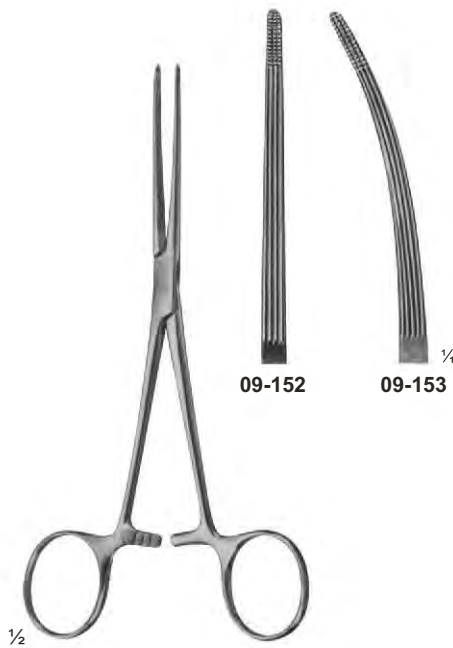

09-152 - 153
BAINBRIDGE
155 mm



09-154
ALLEN
155 mm

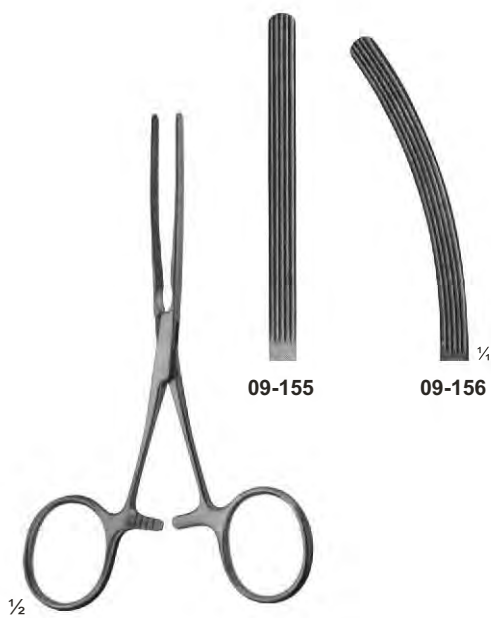

09-155 - 156
BABY-KOCHER
very elastic blades
130 mm

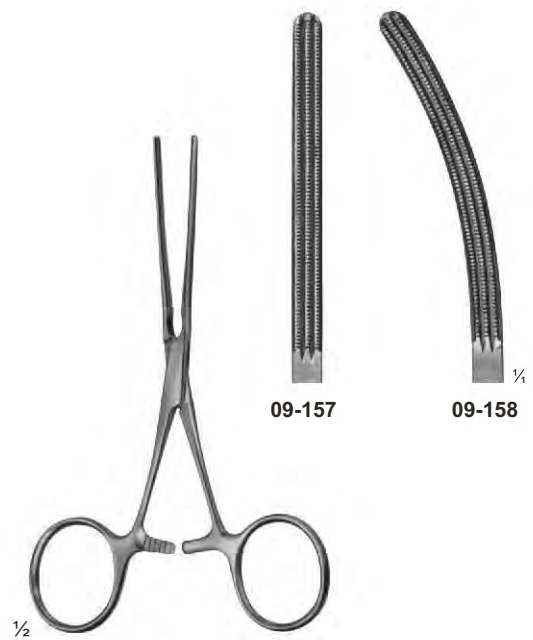

09-157 - 158
BABY-KOCHER
with elastic blades
130 mm

Intestinal Clamps, Soft Elastic

REALSTAR SURGICAL INSTRUMENTS

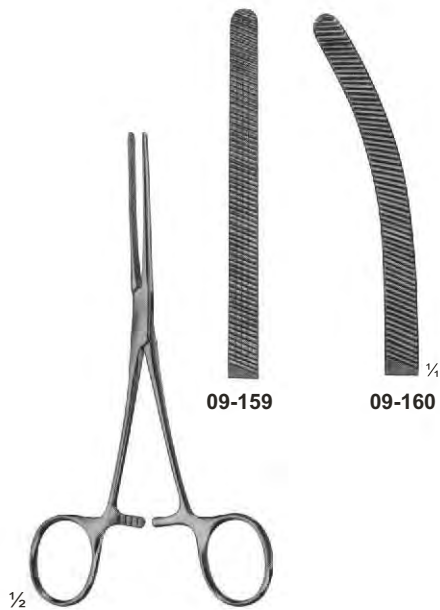

09-159 - 160
DOYEN
elastic
165 mm

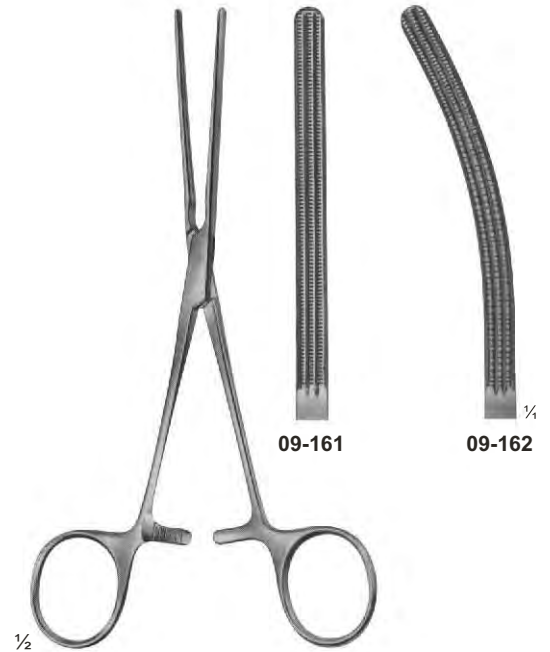

09-161 - 162
DOYEN
with elastic blades
170 mm

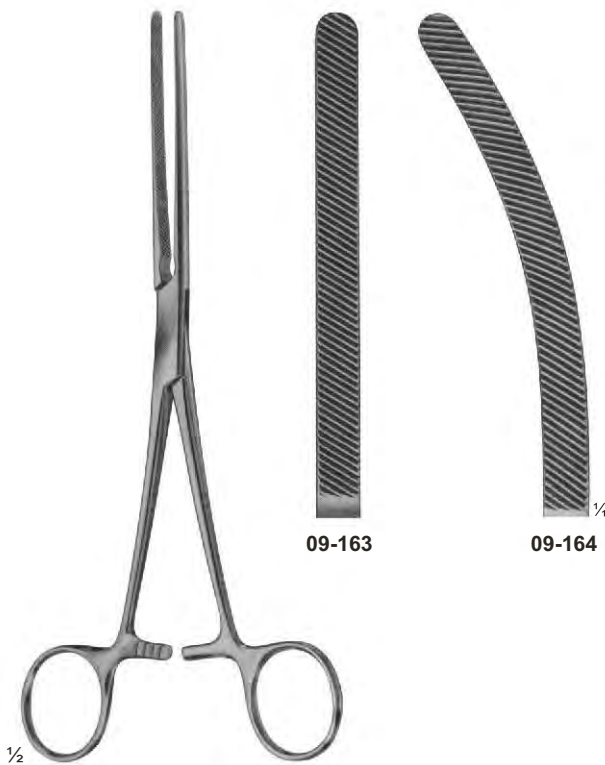

09-163 - 164
HARTMANN
with elastic blades
200 mm



09-165 - 166
HARTMANN
with elastic blades
200 mm

Intestinal Clamps, Soft elastic

REALSTAR SURGICAL INSTRUMENTS

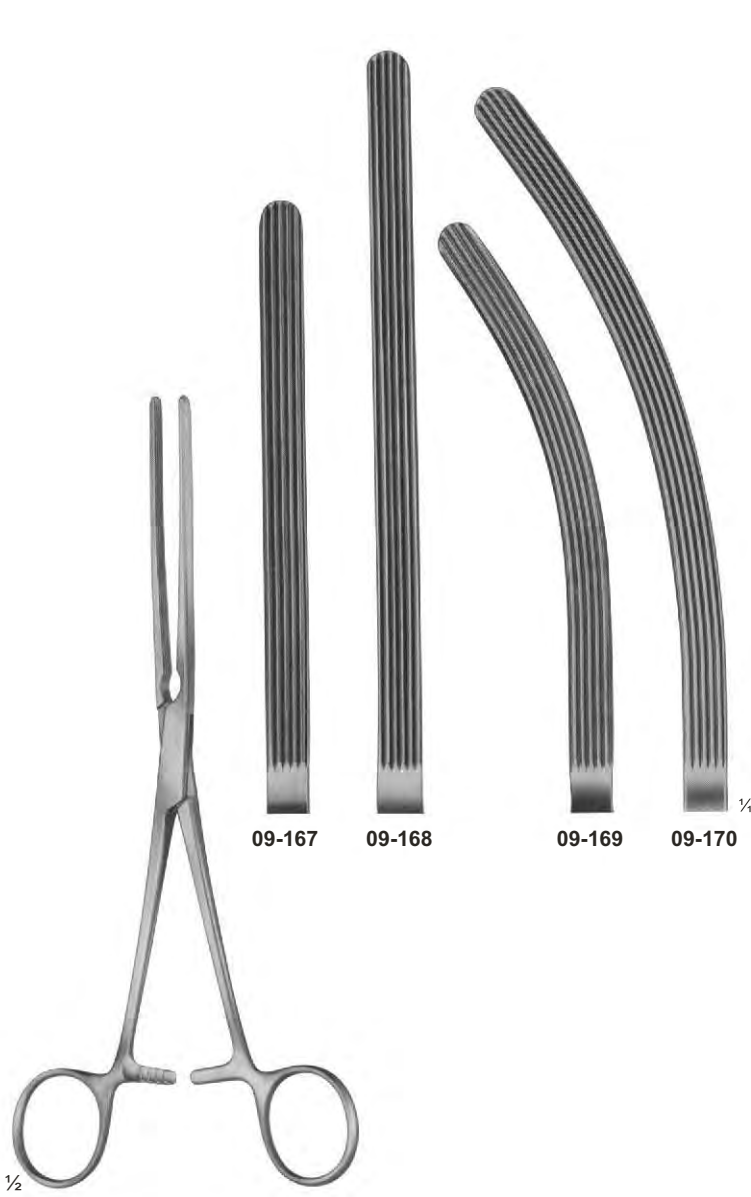

09-167 - 170
KOCHER
with elastic blades
09-169 210 mm
09-170 230 mm

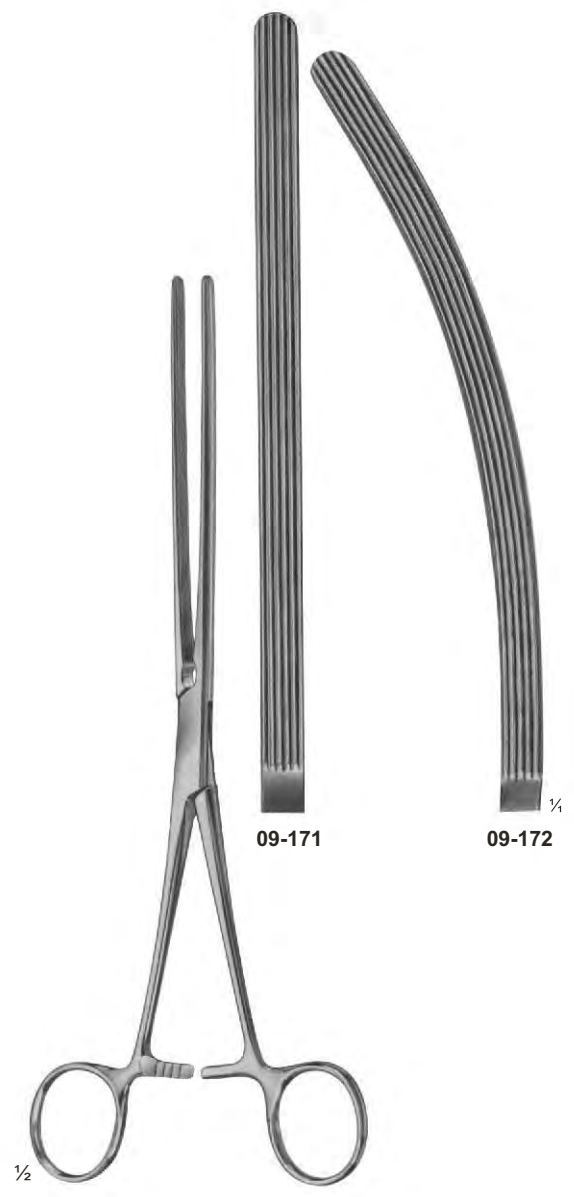

09-171 - 172
DOYEN
with elastic blades
210 mm

Intestinal Clamps, Soft elastic

REALSTAR SURGICAL INSTRUMENTS

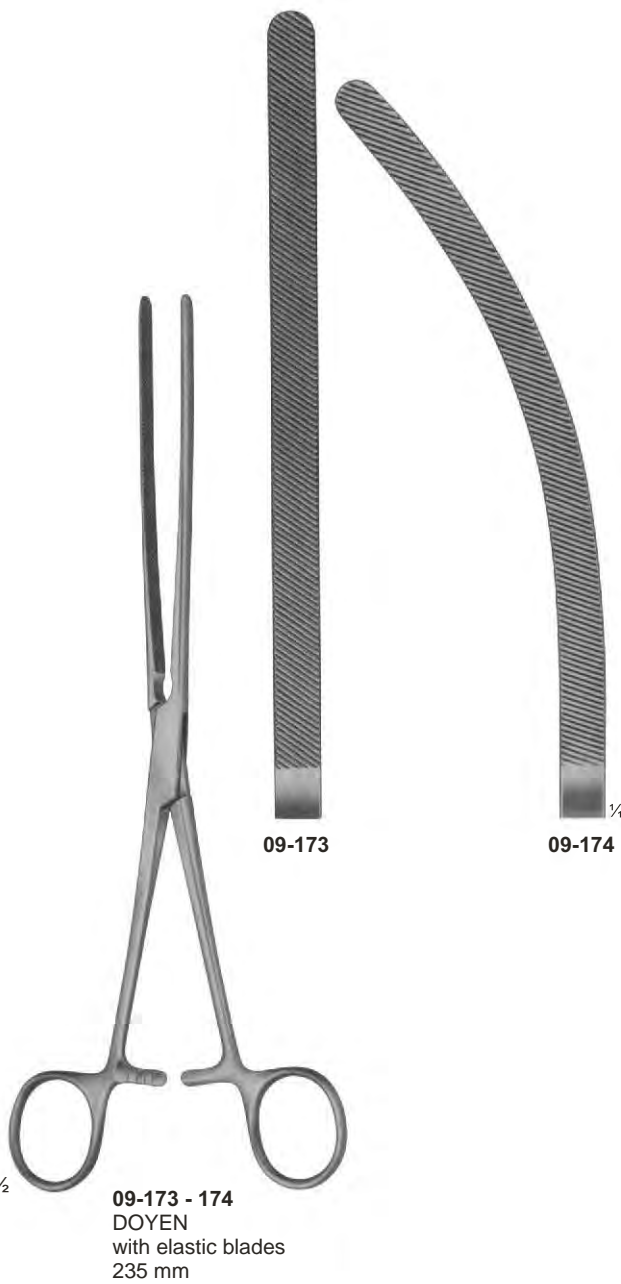

Intestinal Clamps, Soft elastic

REALSTAR SURGICAL INSTRUMENTS

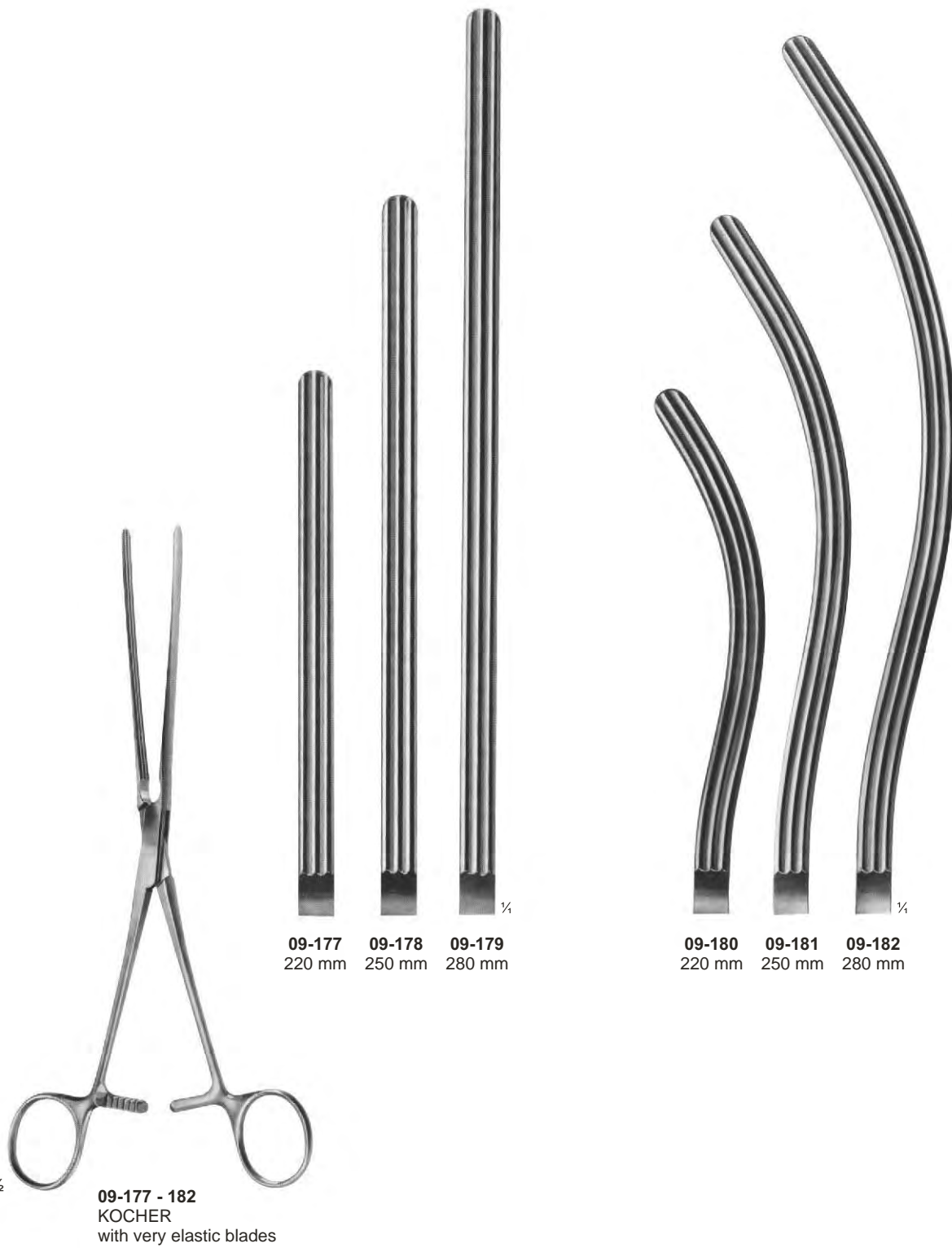

Intestinal Clamps, Soft elastic

REALSTAR SURGICAL INSTRUMENTS



09-183 - 188
KOCHER
with very elastic blades

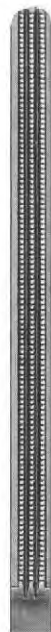

09-183
220 mm



09-184
250 mm



09-185
280 mm



09-186
220 mm



09-187
250 mm



09-188
280 mm

Intestinal Clamps

REALSTAR SURGICAL INSTRUMENTS

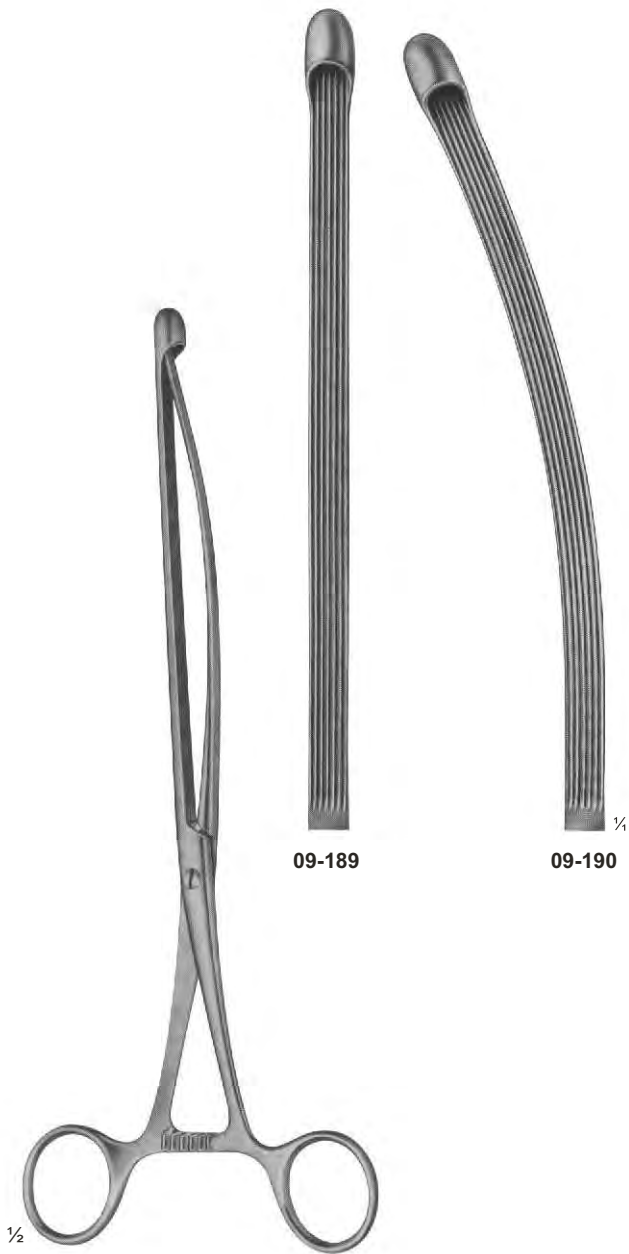

09-189 - 190
NUSSBAUM
with elastic blades
250 mm

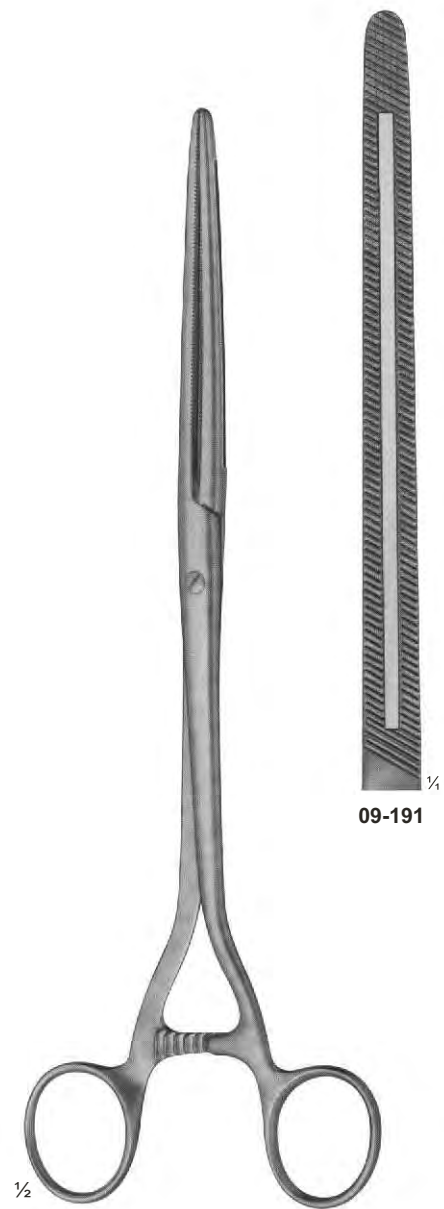

09-191
MOYNIHAN
280 mm

Intestinal Clamps

REALSTAR SURGICAL INSTRUMENTS

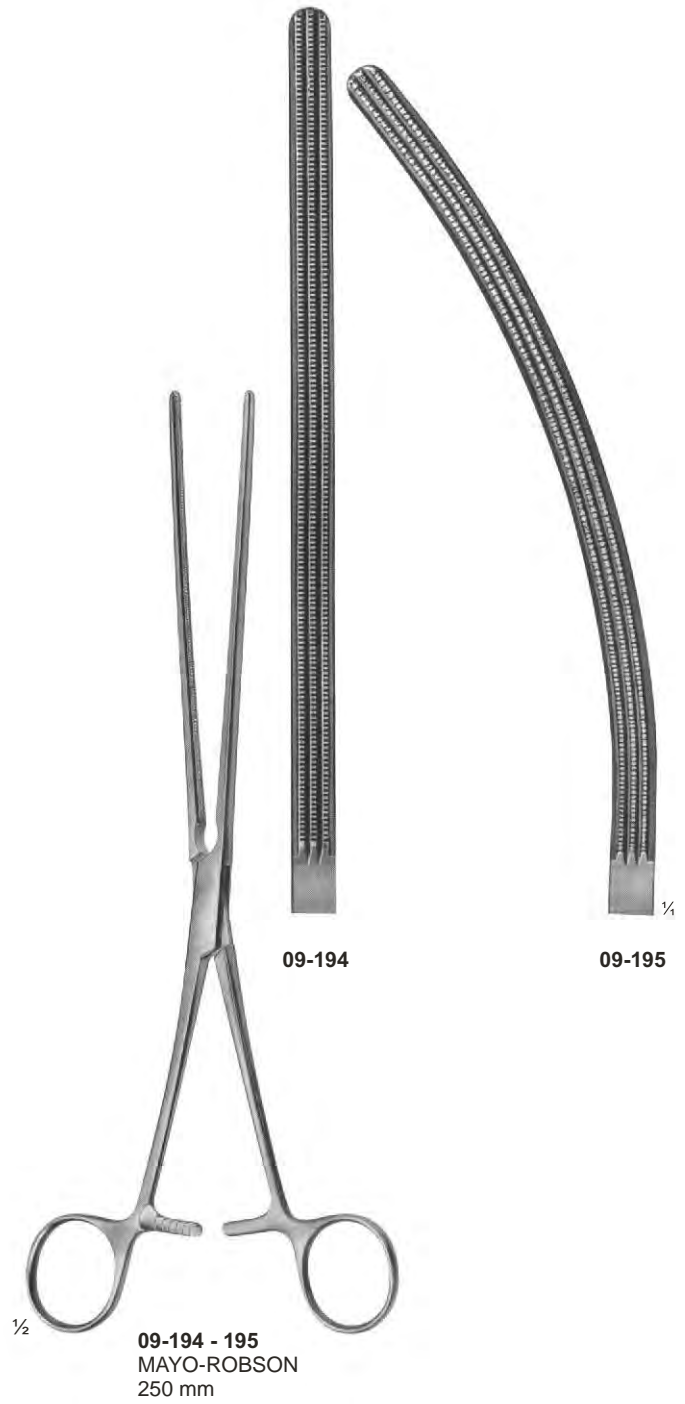
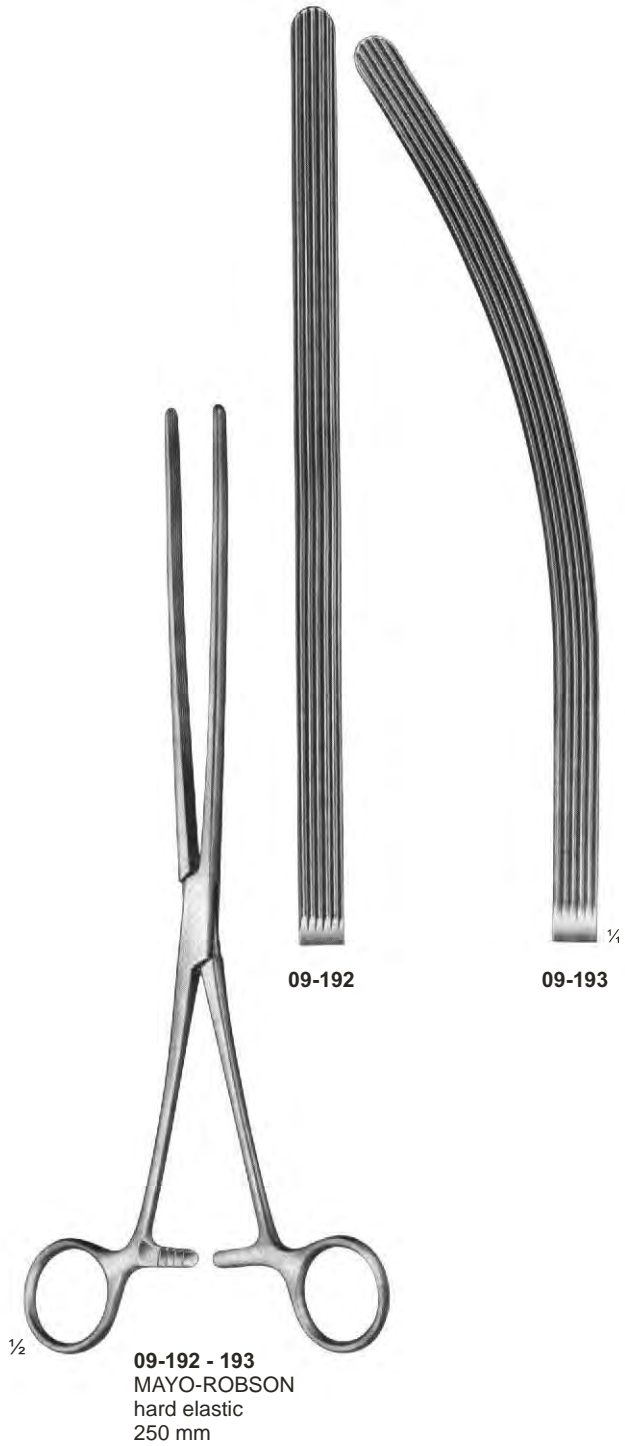

Gastro-Intestinal Forceps, twin

**REALSTAR SURGICAL
INSTRUMENTS**



09-196
LANE
300 mm

09-197
LANE
300 mm

**REALSTAR SURGICAL
INSTRUMENTS**

SERVING TO SAVE LIVES

Stomach Clamps

REALSTAR SURGICAL INSTRUMENTS



Intestinal and Pylorus Clamps

REALSTAR SURGICAL INSTRUMENTS



09-201
PAYR
Intestinal clamp
light pattern,
for children
180 mm

09-202
PAYR
200 mm

09-203
PAYR
275 mm

09-204
PAYR
Pylorus clamp
315 mm

Anastomosis Forceps

REALSTAR SURGICAL INSTRUMENTS



09-205
PARKER-KERR
anastomosis forceps
for colon resection
180 mm

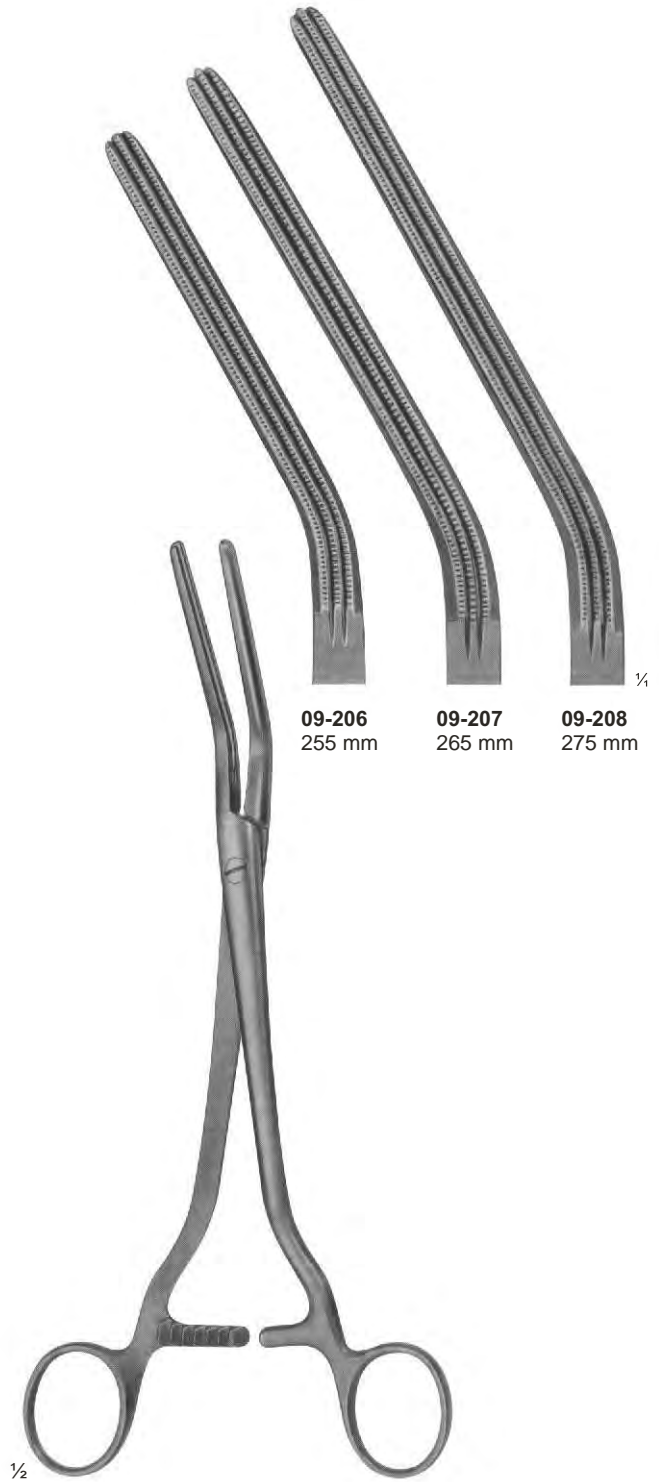

09-206 255 mm
09-207 265 mm
09-208 275 mm

09-206 - 208
DICK
pressure clamps
180 mm

Sigmoid Anastomosis Forceps

REALSTAR SURGICAL INSTRUMENTS



Sigmoid Anastomosis Forceps

REALSTAR SURGICAL INSTRUMENTS

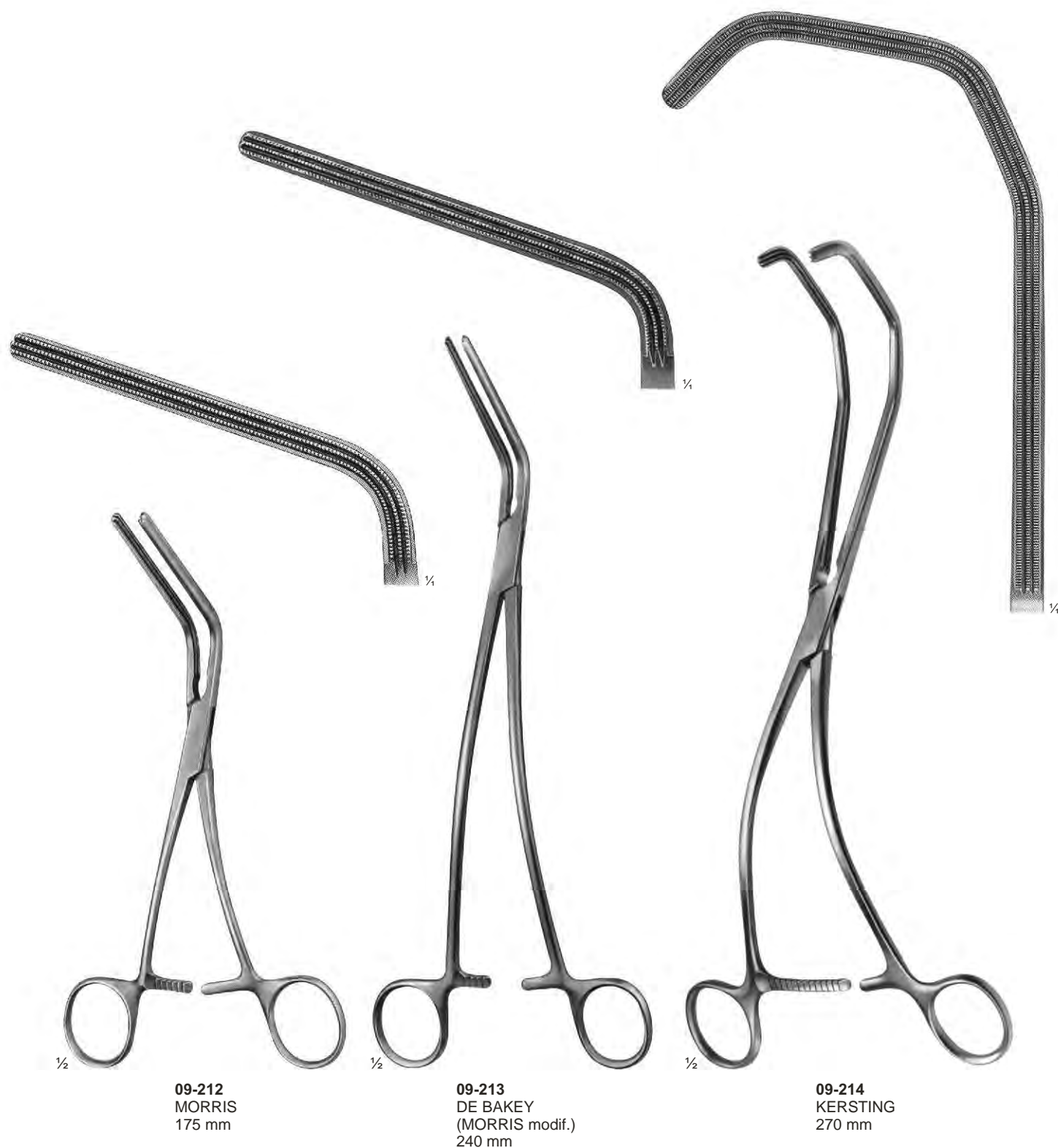

09-212
MORRIS
175 mm

09-213
DE BAKEY
(MORRIS modif.)
240 mm

09-214
KERSTING
270 mm

Rectal Specula

REALSTAR SURGICAL INSTRUMENTS

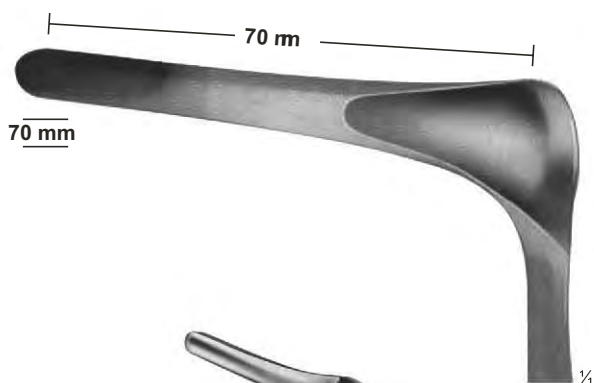

10-101
KILLIAN
for children
145 mm



10-102
SIMS
160 mm



10-103
SIMS
160 mm

Rectal Specula

REALSTAR SURGICAL INSTRUMENTS



10-104 - 107

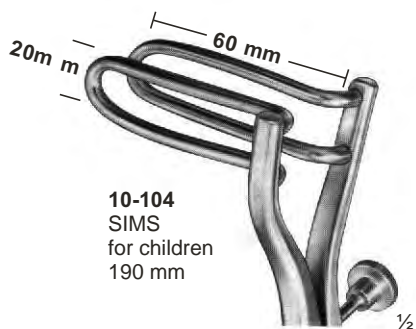

10-104
SIMS
for children
190 mm

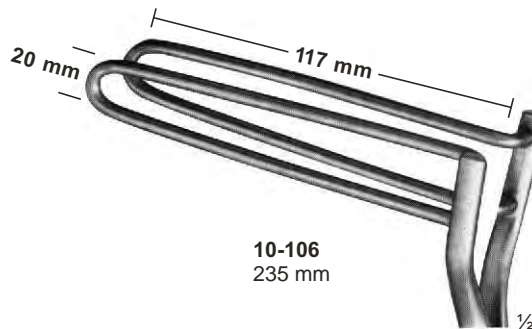

10-106
235 mm

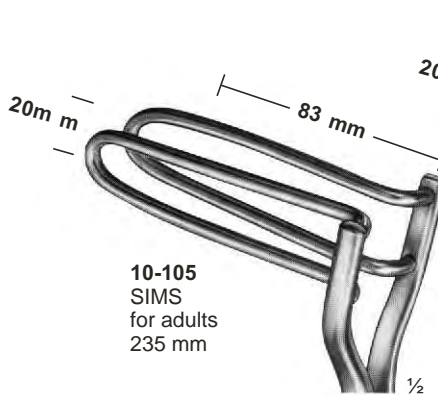

10-105
SIMS
for adults
235 mm

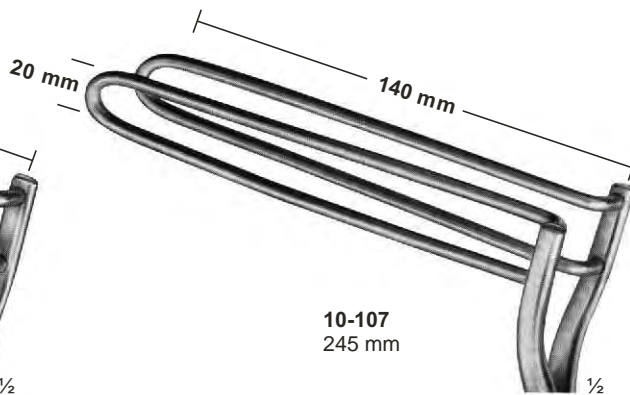

10-107
245 mm



10-108
PRATT
205 mm

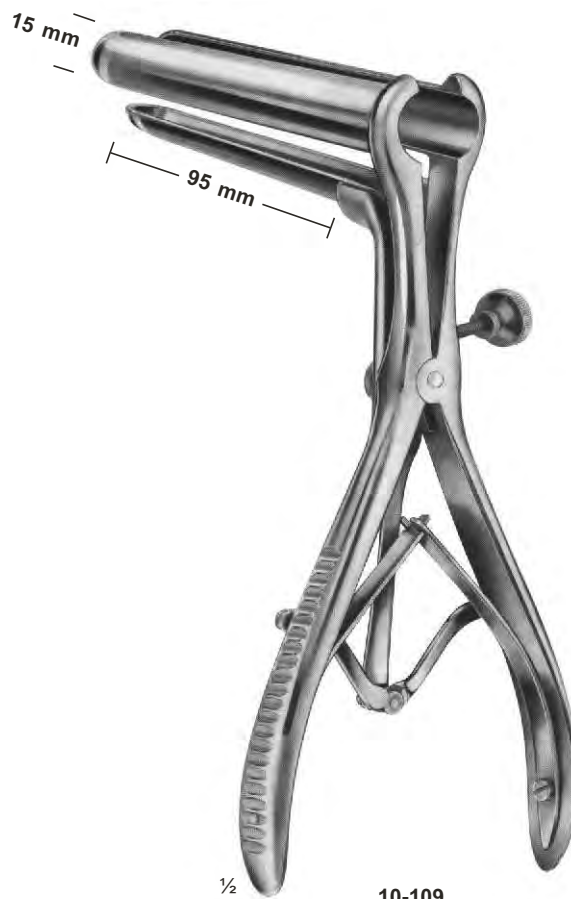

10-109
MATHIEU
215 mm

Anusopes-Sphincteroscopes

REALSTAR SURGICAL INSTRUMENTS



10-110
IVES-FANSLER
Anuscops
145 mm



10-111
KELLY
Sphincteroscope
160 mm

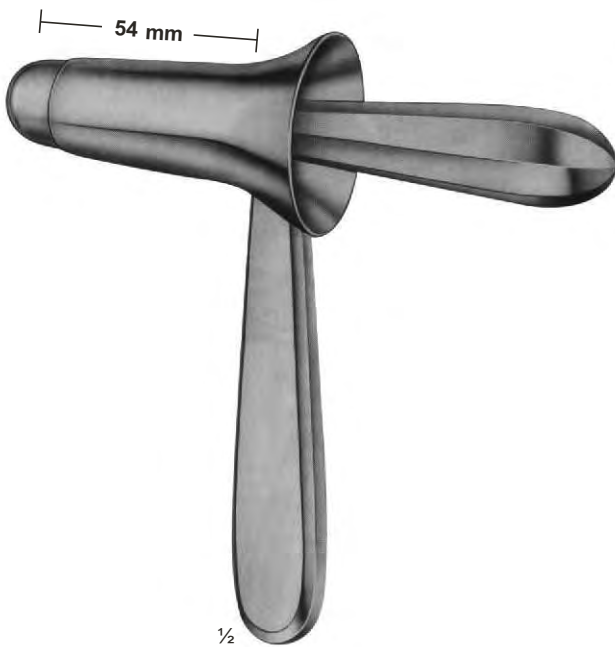

10-112
KELLY
Sphincteroscope
160 mm

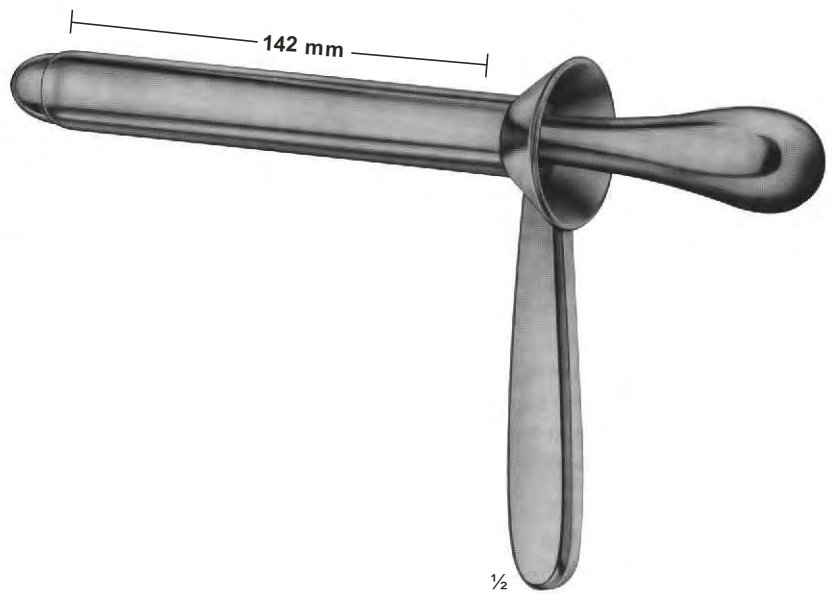

10-113
KELLY
Proctoscope
160 mm

Biopsy forceps for rectum

REALSTAR SURGICAL INSTRUMENTS

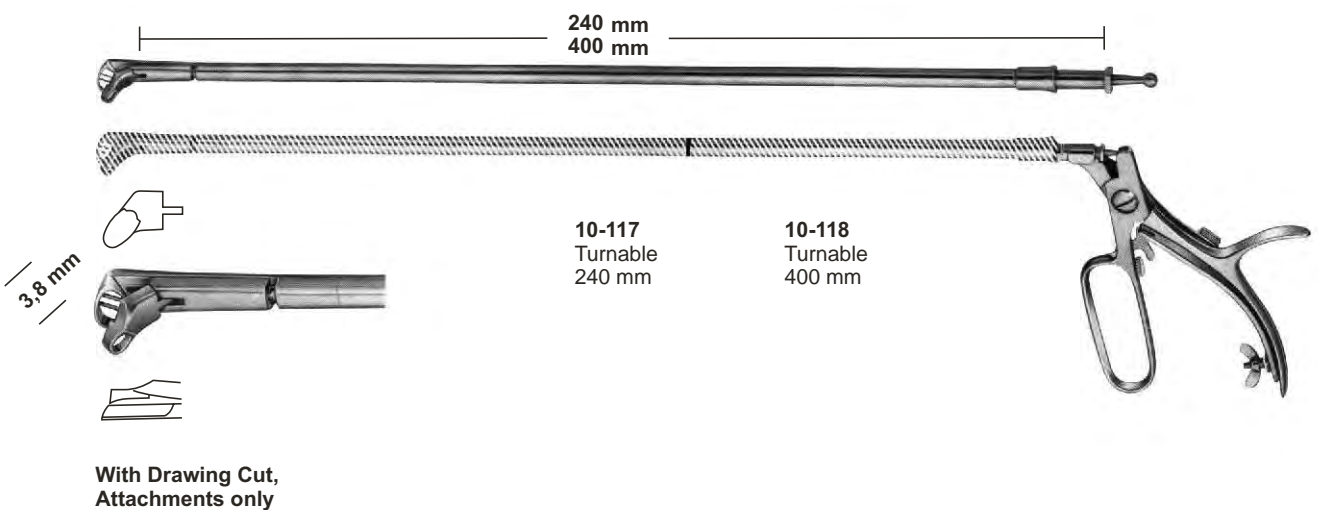
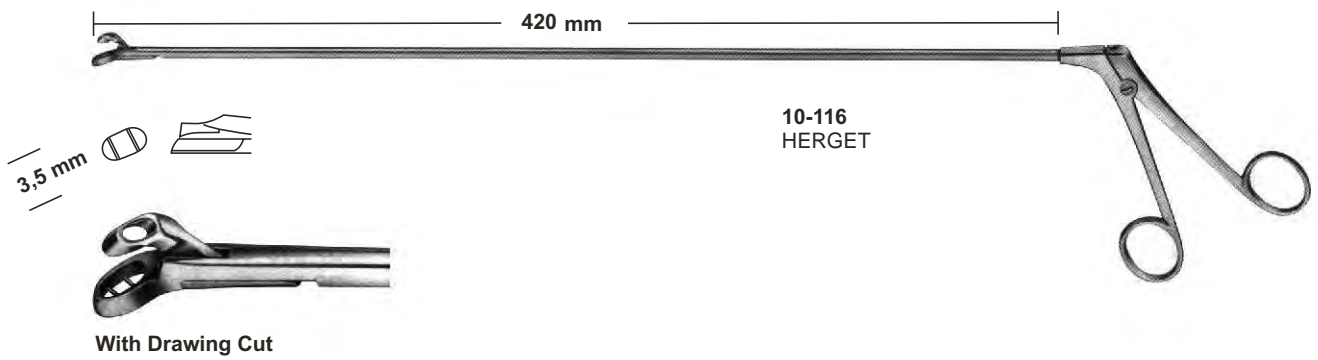
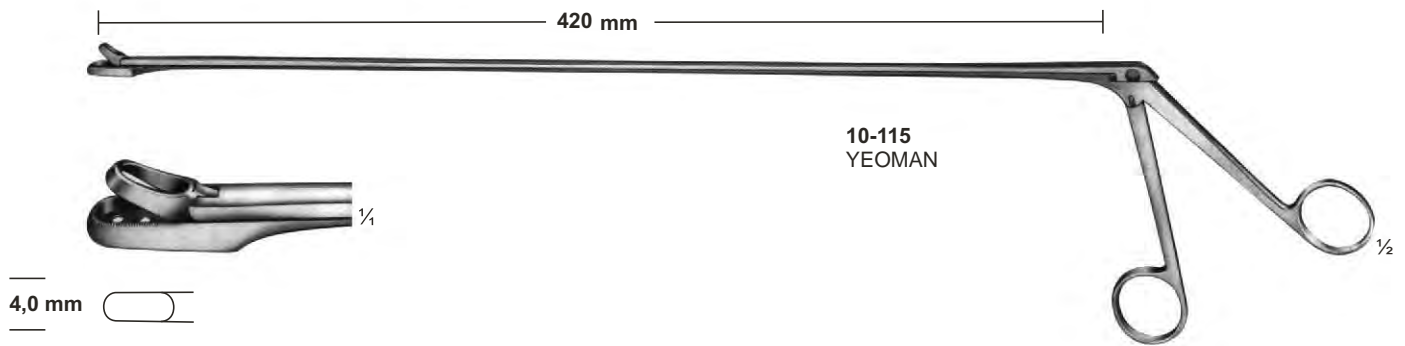
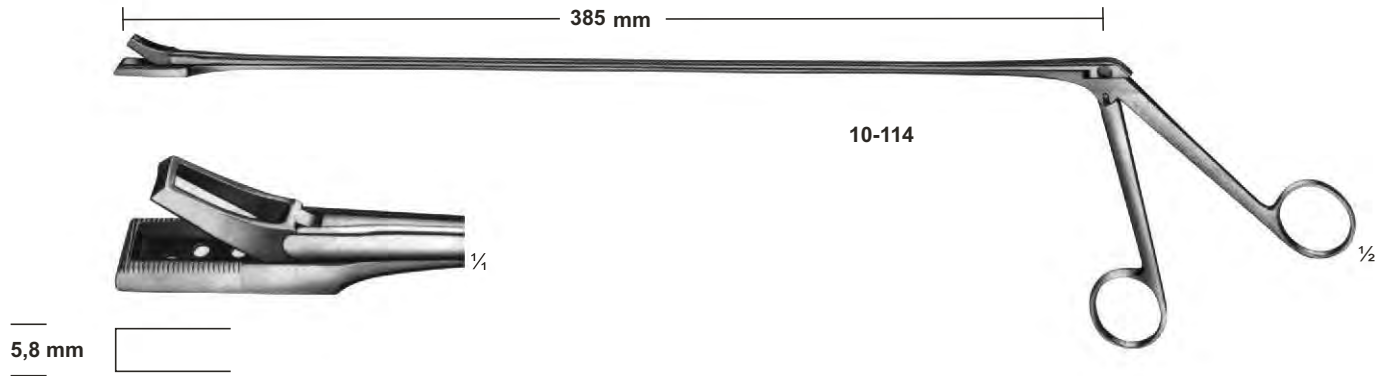

Biopsy Forceps & Swab Holders

REALSTAR SURGICAL INSTRUMENTS

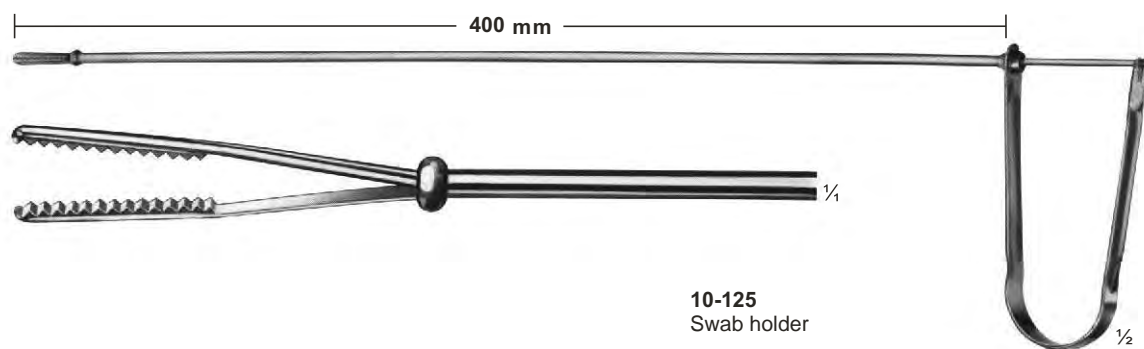
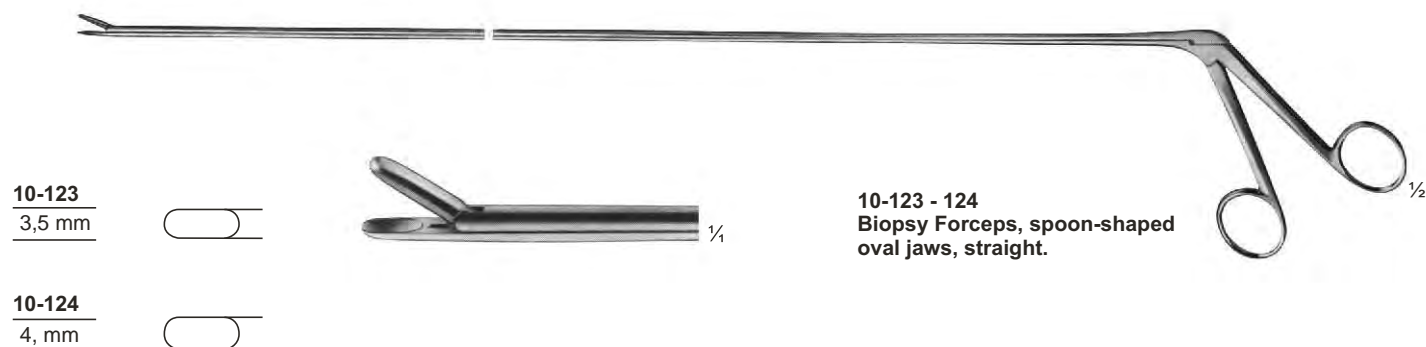
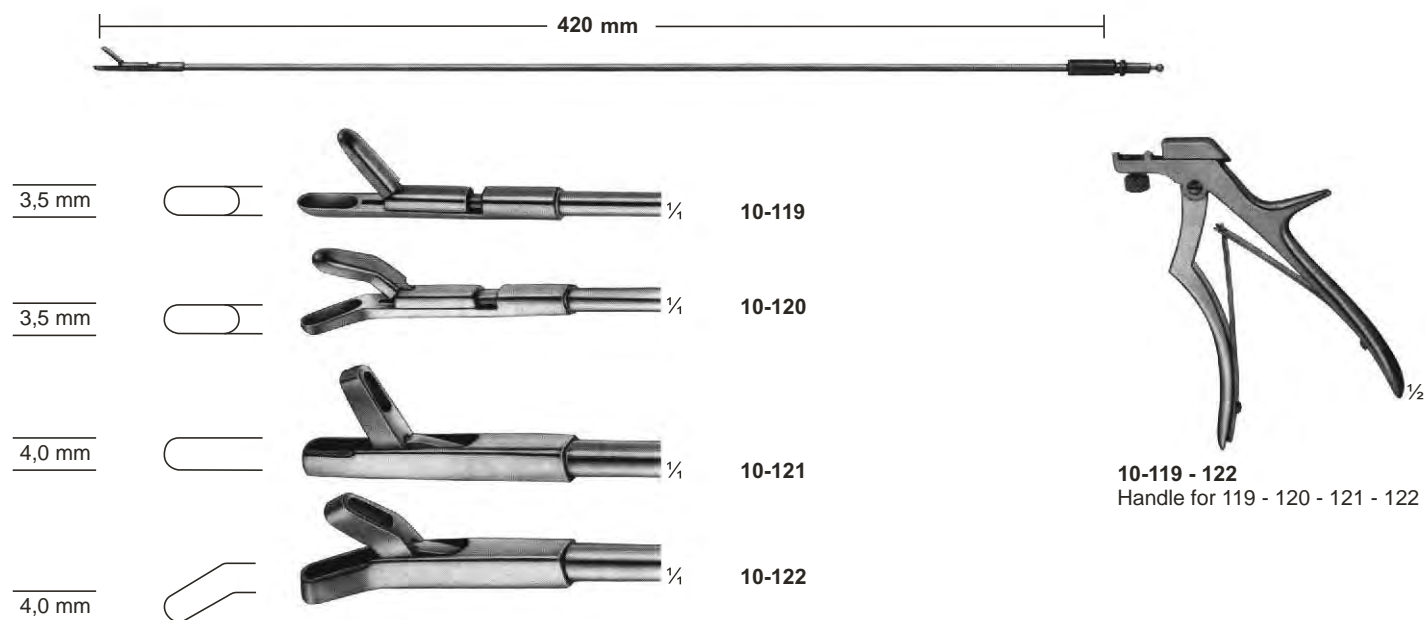

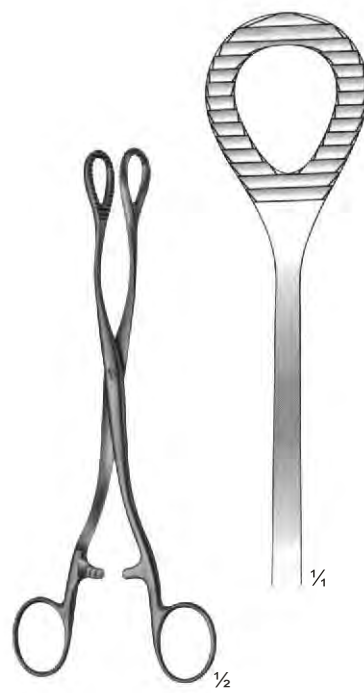
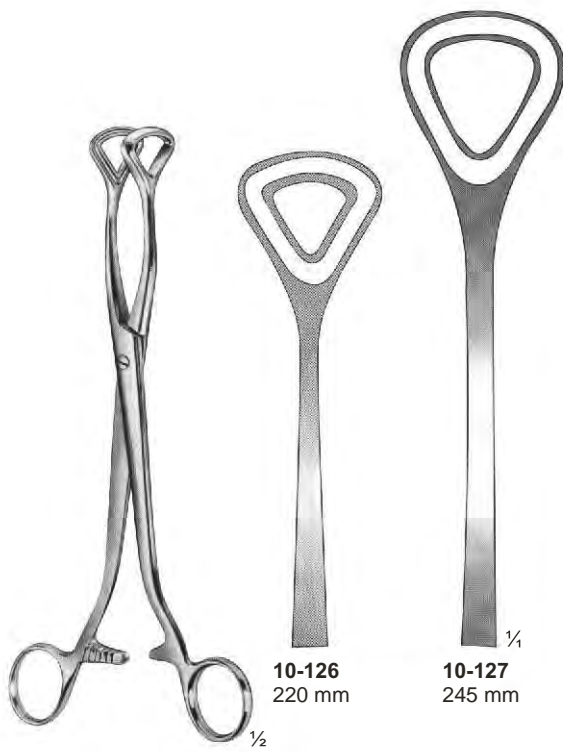

Haemorrhoidal Forceps

REALSTAR SURGICAL INSTRUMENTS

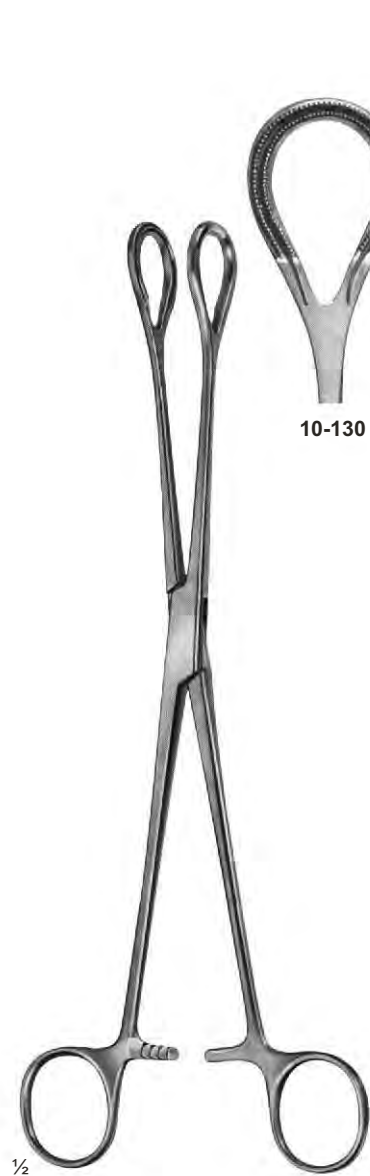

10-130 - 131
250 mm
10-131
270 mm

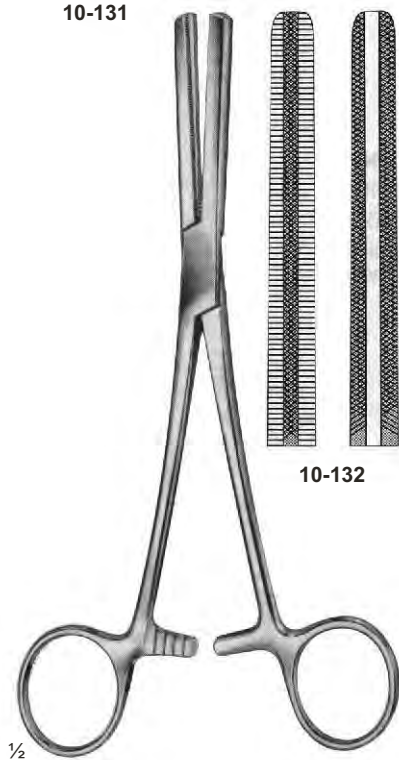

10-132 - 133
FERGUSSON
200 mm

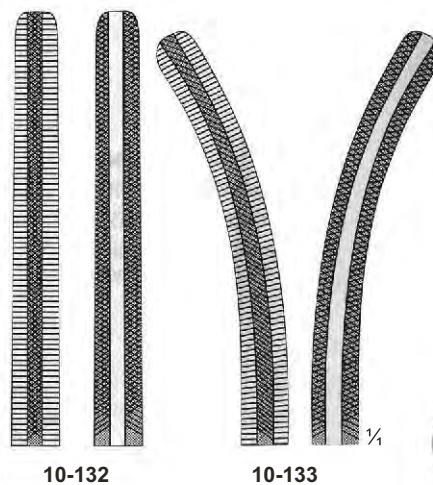

10-134
RUDD
Haemorrhoidal ligator
with loading
attachment and 100
ligature rubber rings
315 mm

Gall Duct Forceps

REALSTAR SURGICAL INSTRUMENTS



10-135
LOWER
180 mm



10-136
LAHEY (SWEET)
190 mm



10-137
LAHEY
220 mm



10-138
DESJARDINS
Gall duct-and cystic forceps



10-139
NISSEN
Gall duct-and cystic forceps
215 mm

Gall Duct Forceps and Choledochus Forceps

REALSTAR SURGICAL INSTRUMENTS

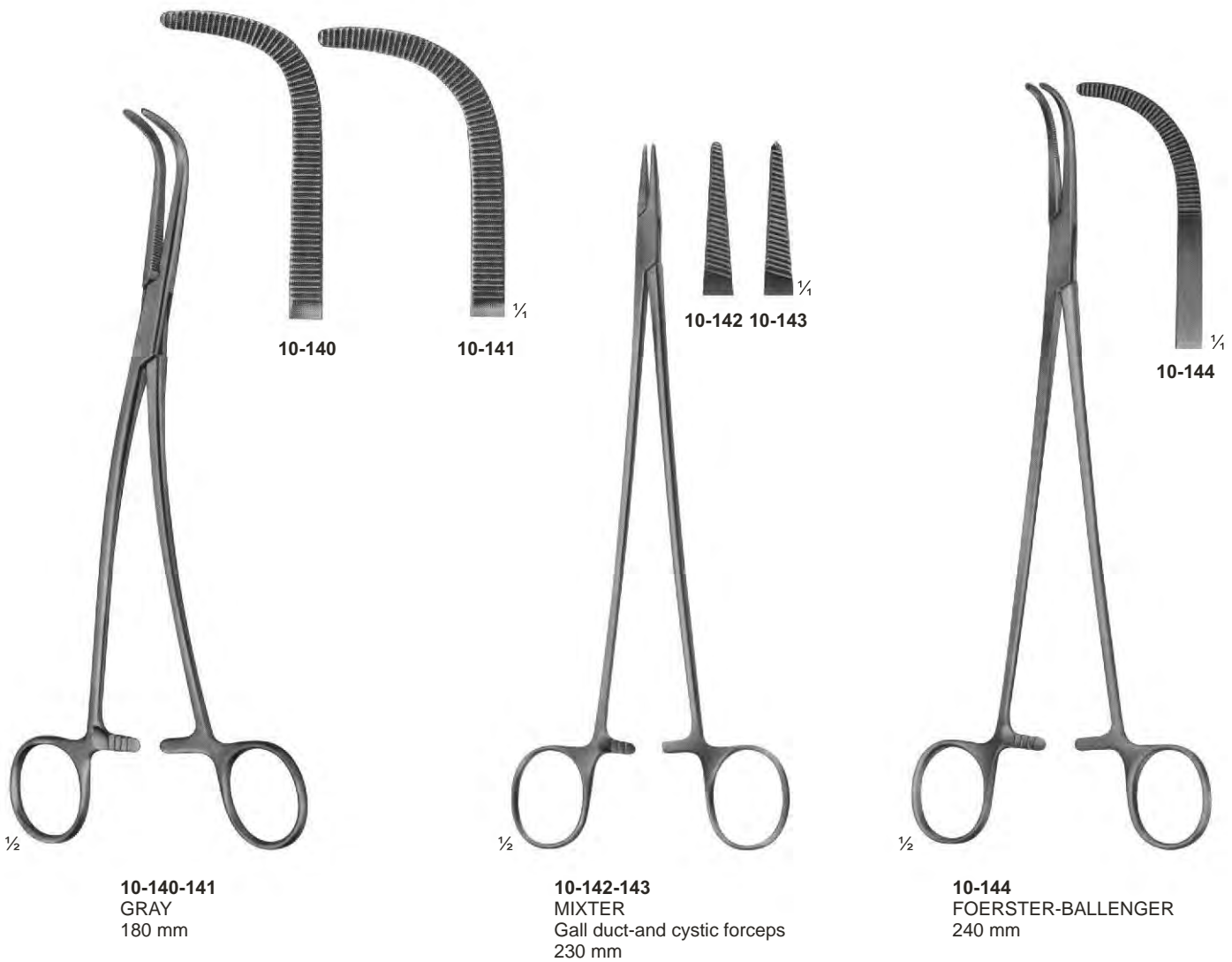

$\frac{1}{2}$

10-140-141
GRAY
180 mm

10-140

10-141

$\frac{1}{2}$

10-142-143
MIXTER
Gall duct-and cystic forceps
230 mm

10-142 10-143

$\frac{1}{2}$

10-144
FOERSTER-BALLENGER
240 mm

10-144

Gall Bladder Forceps and Gall Duct Scissors

REALSTAR SURGICAL INSTRUMENTS

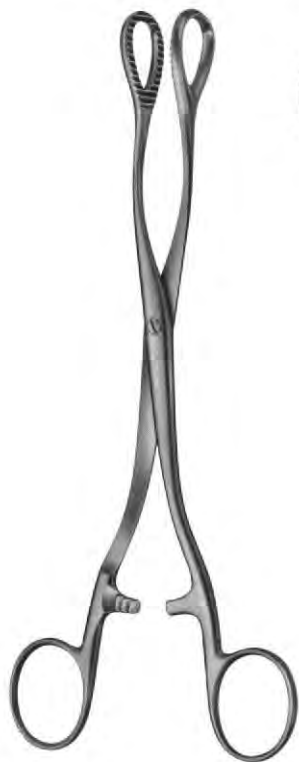
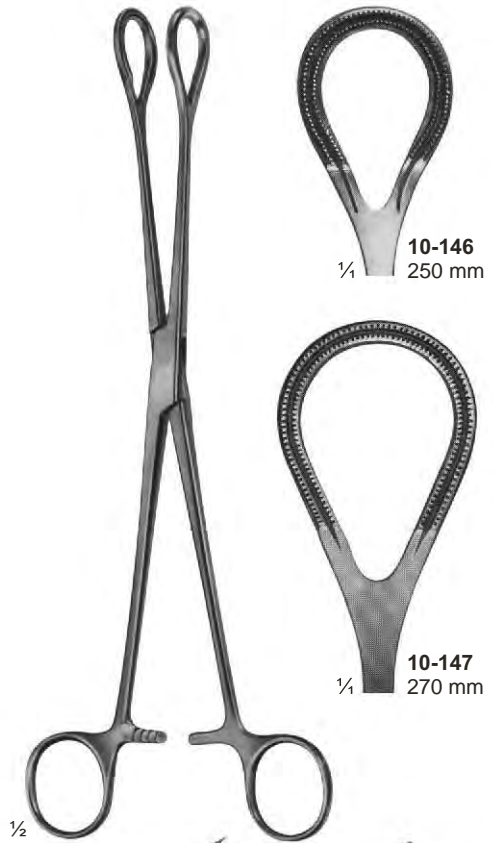
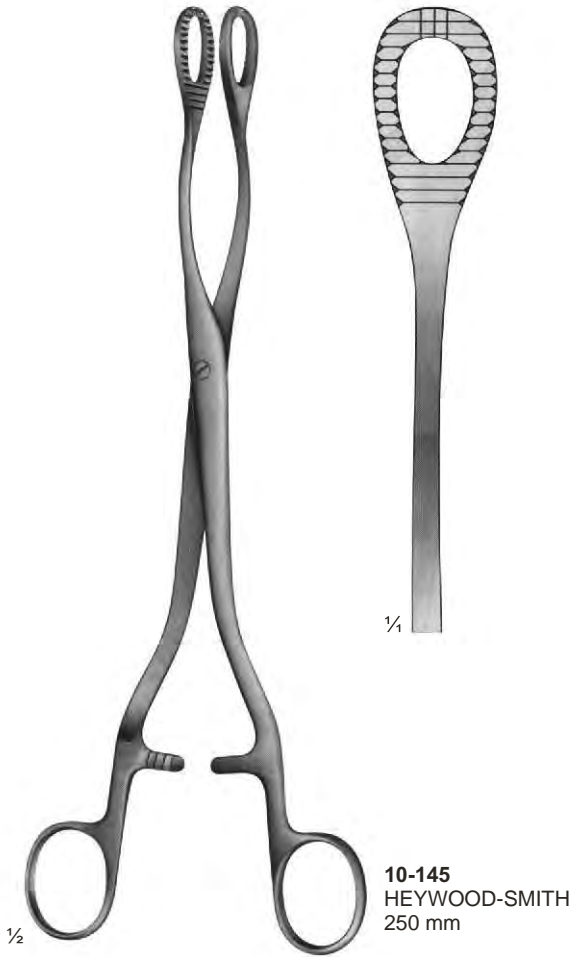

Gall Duct Probes

REALSTAR SURGICAL INSTRUMENTS

Ø 3.5 mm



10-152
HAJEK
Irrigating cannula,
silver
165 mm

Ø 5 mm



10-153
MOYNIHAN
Gall duct probes,
malleable
365 mm

Ø 5 mm



10-154
MAYO
Gall duct probes,
malleable
330 mm

Ø 3.5 mm

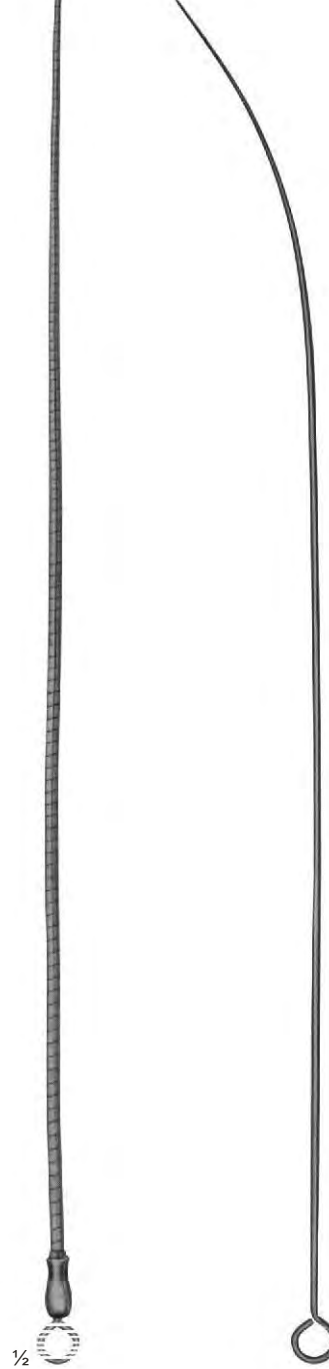

10-155
OCHSNER
Gall duct probes, flexible
400 mm

Ø 3.8 mm



10-156



10-157



10-158

10-156 - 158
DESJARDINS
Gall duct probes,
flexible
285 mm

Gall Duct Dilators & Gall Stone Scoops

REALSTAR SURGICAL INSTRUMENTS

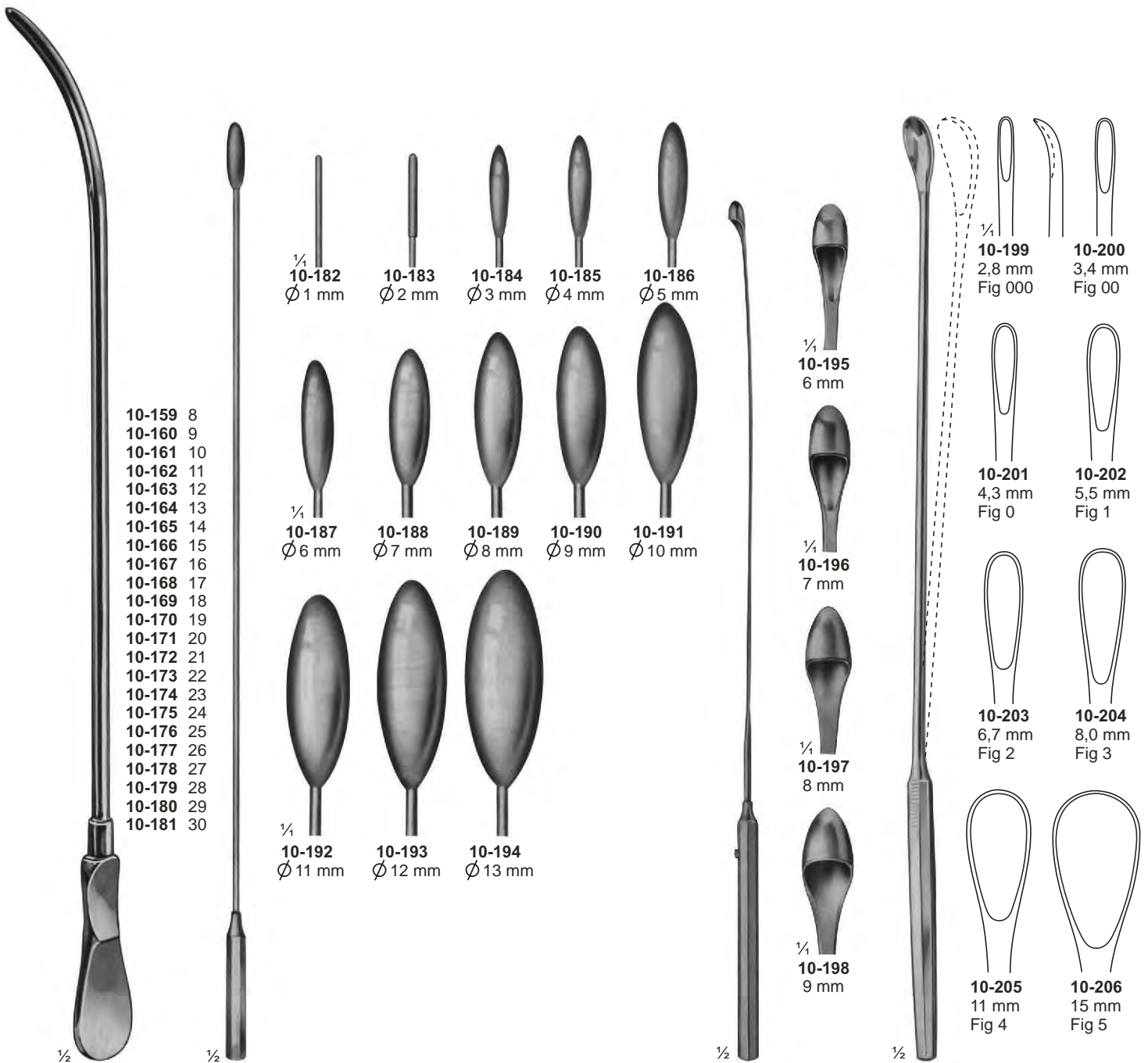

- 10-159 8
- 10-160 9
- 10-161 10
- 10-162 11
- 10-163 12
- 10-164 13
- 10-165 14
- 10-166 15
- 10-167 16
- 10-168 17
- 10-169 18
- 10-170 19
- 10-171 20
- 10-172 21
- 10-173 22
- 10-174 23
- 10-175 24
- 10-176 25
- 10-177 26
- 10-178 27
- 10-179 28
- 10-180 29
- 10-181 30

10-159 - 181
DITTEL
Metall bougies and dilating sounds, stiff 345 mm

10-182 - 194
BAKES
Common bile duct dilators, malleable 315 mm, 320 mm

10-195 - 198
DESJARDINS
Probes and catch with flexible shaft 300 mm

10-199 - 206
LUER-KORTE modif with malleable shaft 310 mm

Gall Stone Forceps

REALSTAR SURGICAL INSTRUMENTS

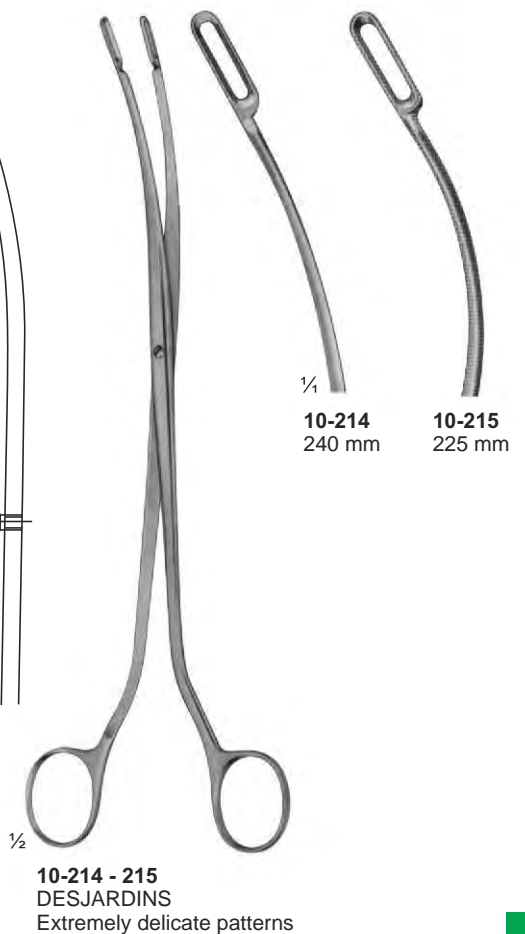
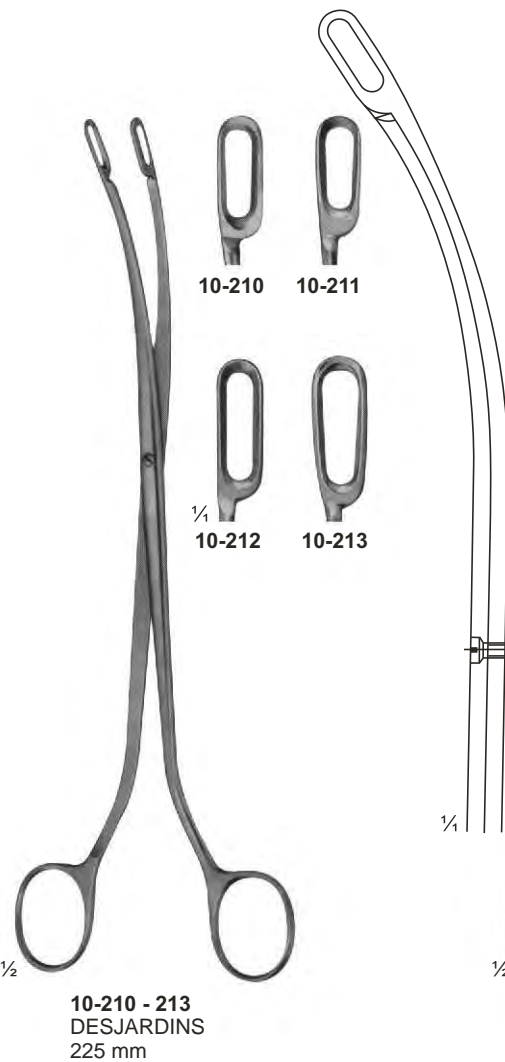
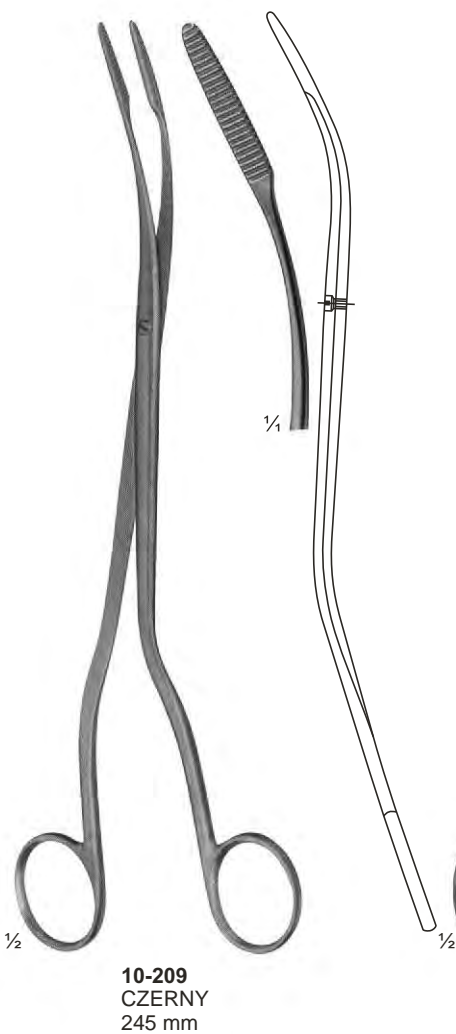
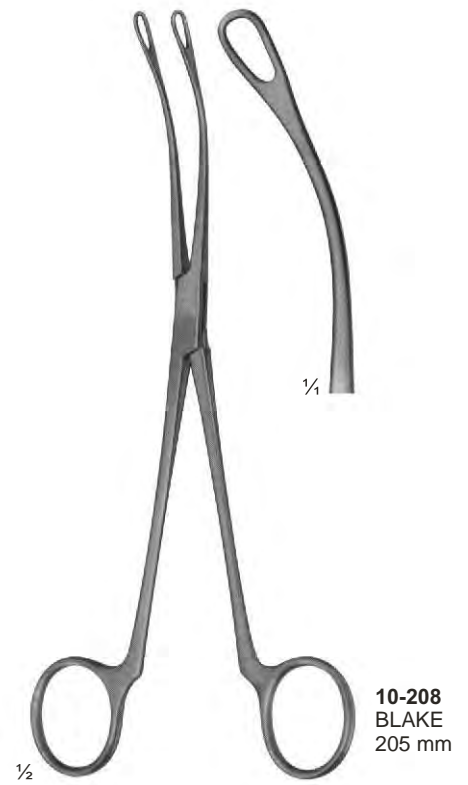
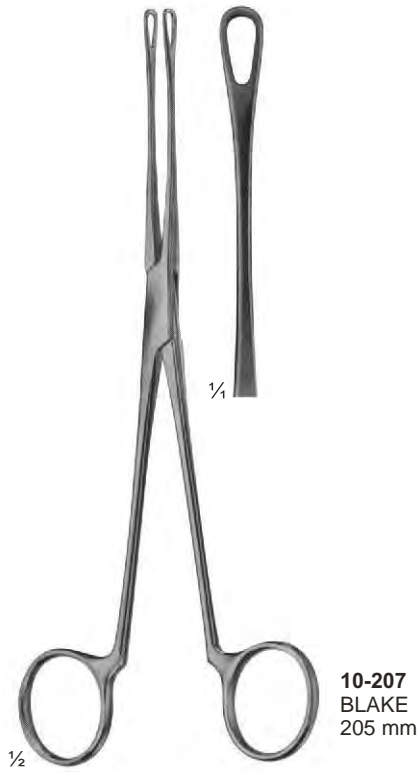

Kidney Clamps

REALSTAR SURGICAL INSTRUMENTS



Kidney Clamps

REALSTAR SURGICAL INSTRUMENTS

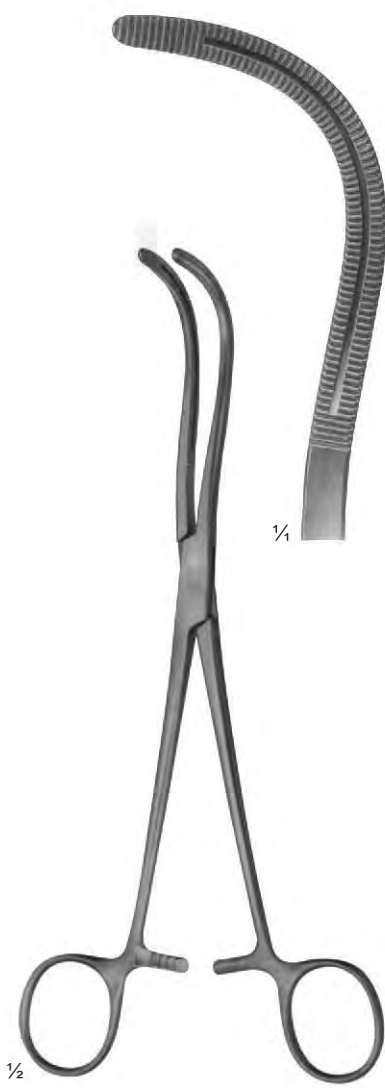

10-222
STILLE
220 mm

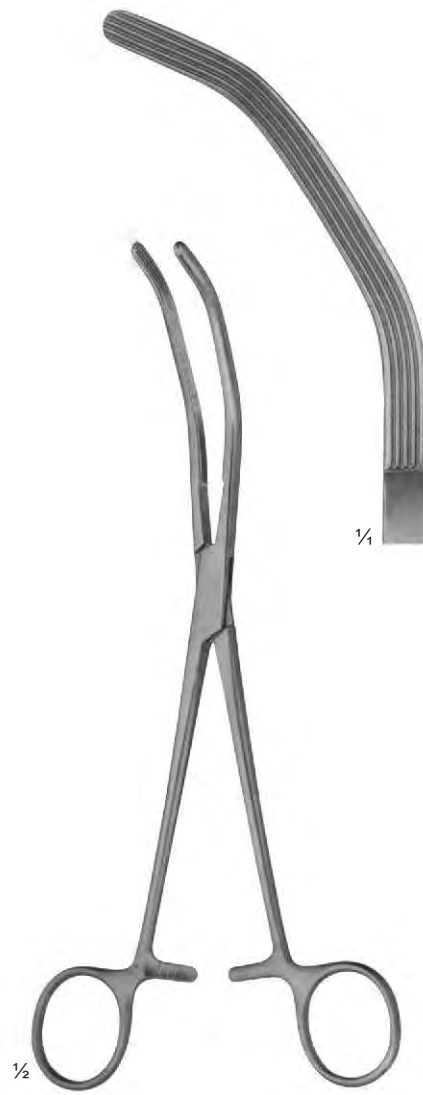

10-223
HERRICK
225 mm

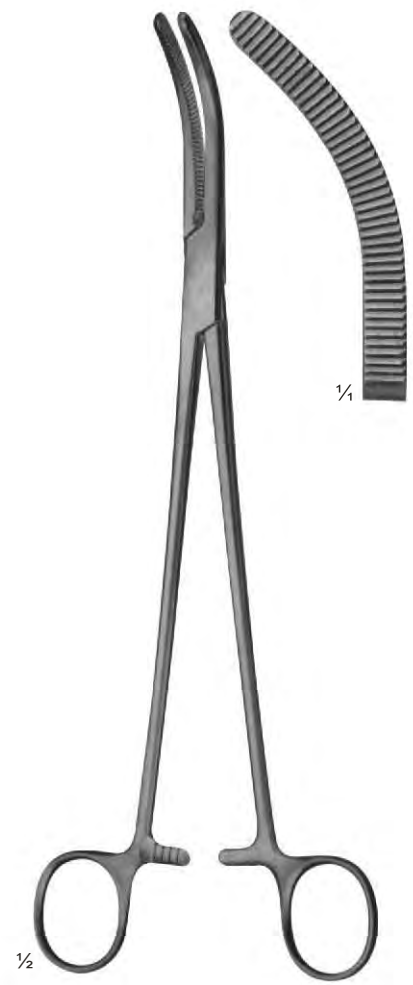

10-224
WERTHEIM
225 mm

Kidney Elevating Forceps

**REALSTAR SURGICAL
INSTRUMENTS**



**10-225
COLLIN
285 mm**



**10-226
DARTIGUES
255 mm**

**REALSTAR SURGICAL
INSTRUMENTS**

SERVING TO SAVE LIVES

Kidney Stone Forceps

REALSTAR SURGICAL INSTRUMENTS



10-227



10-228



10-229



10-229



10-230



10-231



10-232



10-233



1/2

10-227 - 230
RANDALL
225 mm



1/2

10-231 - 233
RANDALL
190 mm

Bladder Retractors

REALSTAR SURGICAL INSTRUMENTS

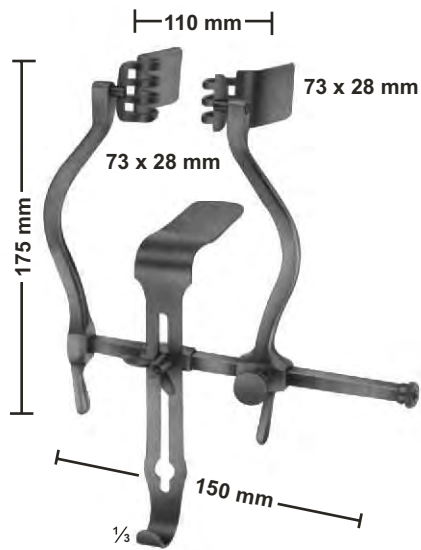

11-101
JUDD-MASSON
 Bladder and suprapubic retractor



11-102
MILLIN
 Bladder retractor
 105X45 mm



11-103
LEGUEU
 Bladder retractor
 Center blade
 80 x 31 mm

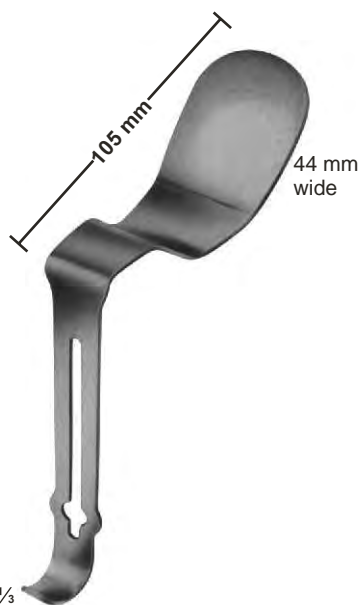

11-104
MILLIN
 Center bladder for retro pubic prostatectomy



11-105
KOCHER
 Bladder spatula
 235 mm



11-106
MATHIEU
Foreign body forceps
Length of shaft
190 mm

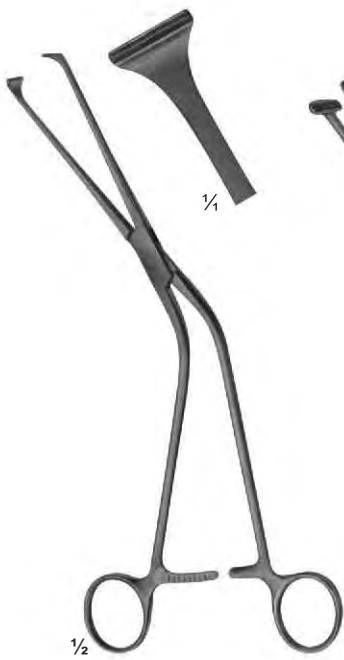

11-107
MILLIN
Lobe grasping
forceps
245 mm

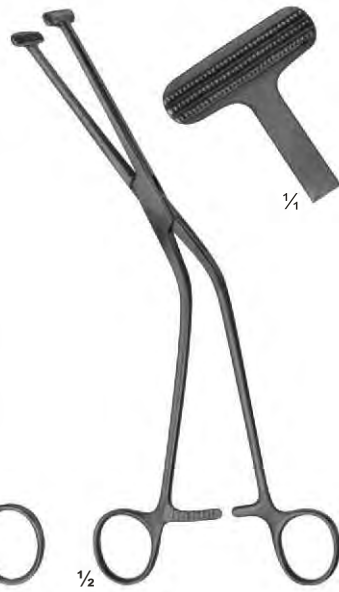

11-108
MILLIN
Lobe grasping
forceps
235 mm



11-109
MILLIN
Bladder neck spreader
285 mm

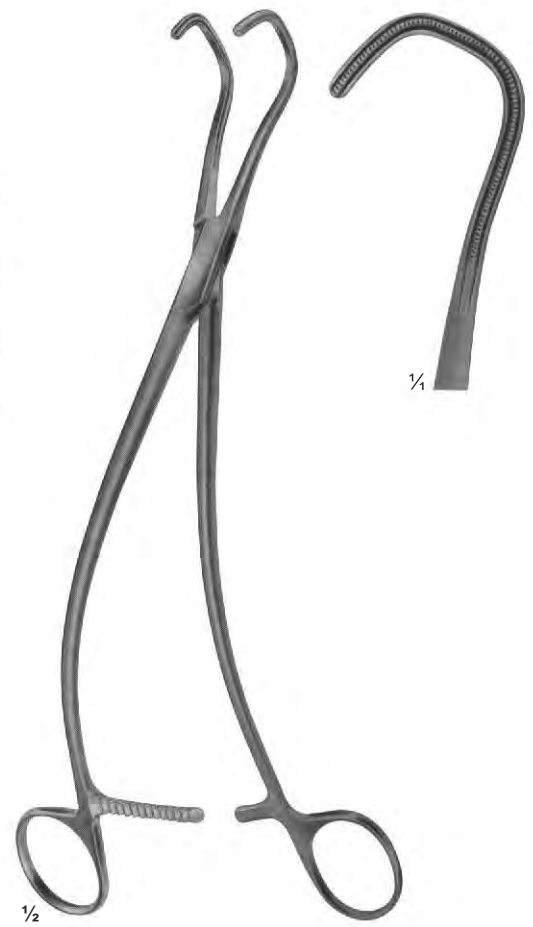

11-110
Ureter forceps
240 mm

Genito-Urinary Instruments

REALSTAR SURGICAL INSTRUMENTS



11-111
GUYON
Catheter guide
(introducer)
365 mm

- 11-112 6
- 11-113 7
- 11-114 8
- 11-115 9
- 11-116 10
- 11-117 11
- 11-118 12
- 11-119 13
- 11-120 14
- 11-121 15
- 11-122 16
- 11-123 18
- 11-124 20

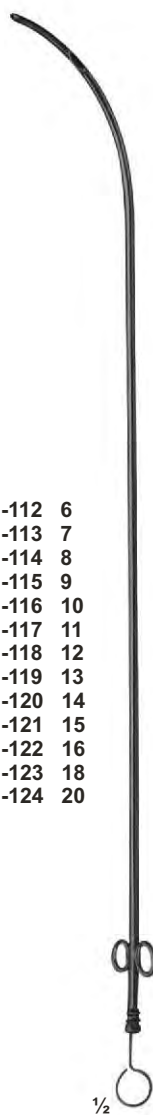

11-112 - 124
Female catheters,
metal
160 mm

- 11-125 8
- 11-126 9
- 11-127 10
- 11-128 11
- 11-129 12
- 11-130 13
- 11-131 14
- 11-132 15
- 11-133 16
- 11-134 17
- 11-135 18
- 11-136 19
- 11-137 20
- 11-138 21
- 11-139 22
- 11-140 23
- 11-141 24
- 11-142 25
- 11-143 26
- 11-144 27
- 11-145 28
- 11-146 29
- 11-147 30



11-125 - 147
Urethral bougies
and dilating sounds
345 mm

- 11-148 Ben. 24/Charr. 12
- 11-149 Ben. 25
- 11-150 Ben. 26/Charr. 13
- 11-151 Ben. 27
- 11-152 Ben. 28/Charr. 14
- 11-153 Ben. 29
- 11-154 Ben. 30/Charr. 15
- 11-155 Ben. 31
- 11-156 Ben. 32/Charr. 16
- 11-157 Ben. 33
- 11-158 Ben. 34/Charr. 17
- 11-159 Ben. 35
- 11-160 Ben. 36/Charr. 18
- 11-161 Ben. 37
- 11-162 Ben. 38/Charr. 19
- 11-163 Ben. 39
- 11-164 Ben. 40/Charr. 20
- 11-165 Ben. 41
- 11-166 Ben. 42/Charr. 21
- 11-167 Ben. 43
- 11-168 Ben. 44/Charr. 22
- 11-169 Ben. 45
- 11-170 Ben. 46/Charr. 23
- 11-171 Ben. 47
- 11-172 Ben. 48/Charr. 24
- 11-173 Ben. 49
- 11-174 Ben. 50/Charr. 25
- 11-175 Ben. 51
- 11-176 Ben. 52/Charr. 26
- 11-177 Ben. 53
- 11-178 Ben. 54/Charr. 27
- 11-179 Ben. 55
- 11-180 Ben. 56/Charr. 28
- 11-181 Ben. 57
- 11-182 Ben. 58/Charr. 29
- 11-183 Ben. 59
- 11-184 Ben. 60/Charr. 30

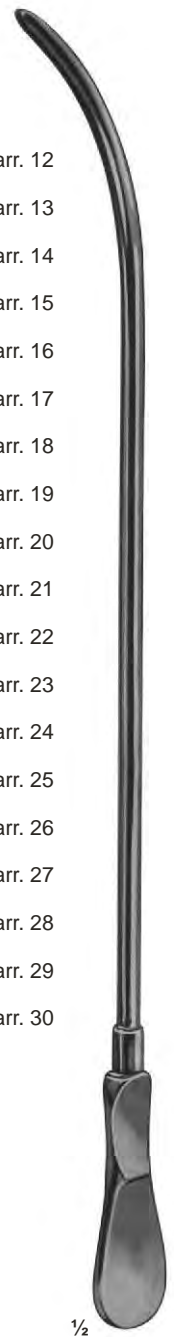

11-148 - 184
Urethral bougies
and dilating sounds
255 mm



11-185
GUYON
Set of urethral bougies and dilating sounds,
in metal case, with lift out rack and bottom
rack, containing 21 urethral and dilating sounds.



11-186
WINKELMANN

12 mm / 16 mm / 20 mm

Trocars

REALSTAR SURGICAL INSTRUMENTS



11-187
KLIMA ROSEGGER
35 X 1,8 mm
Sternal puncture needle

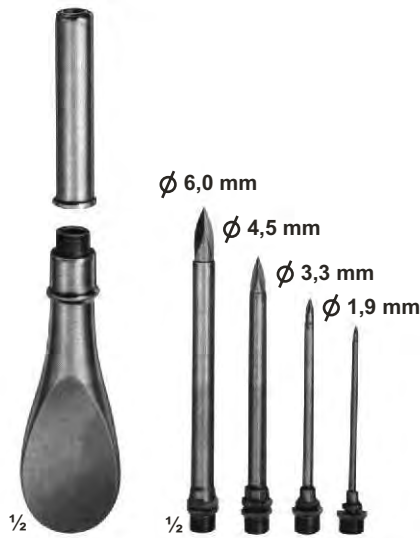

11-188
Universal trocar
with 4 tips



11-189 - 193
Inside dime. Outside dime
11-189 2,2 mm 3,0 mm
11-190 3,0 mm 4,0 mm
11-191 4,0 mm 5,0 mm
11-192 5,0 mm 6,0 mm
11-193 5,5 mm 6,5 mm
for hydrocele and abdominal puncture



11-194 - 197
Inside dime. Outside dime
11-194 2,2 mm 3,0 mm
11-195 3,0 mm 4,0 mm
11-196 4,0 mm 5,0 mm
11-197 5,0 mm 6,0 mm
for abdominal puncture,
with stop-cock and lateral
drain

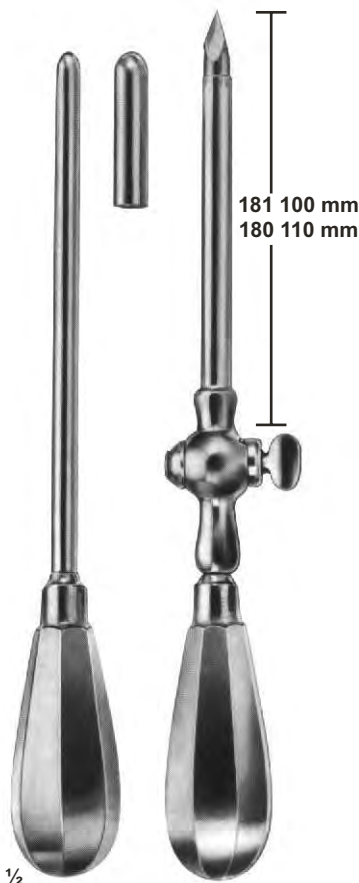

11-198 - 199
Inside dime. Outside dime
11-198 6,5 mm 8,0 mm
11-199 9,0 mm 10,0 mm
Empyema trocar

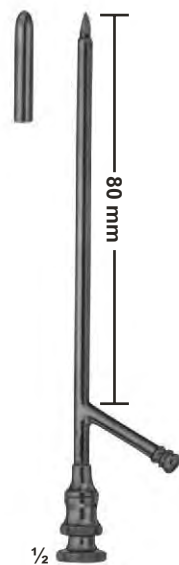

11-200 - 203
Inside dime. Outside dime
11-200 3,0 mm 4,0 mm
11-201 3,6 mm 4,6 mm
11-202 4,3 mm 5,3 mm
11-203 5,0 mm 6,0 mm
Gall bladder trocars



11-204
PIERCE
Antrum trocar
4,0 mm



11-205
COAKLEY
Antrum trocar
3,0 mm

Vaginal specula

REALSTAR SURGICAL INSTRUMENTS

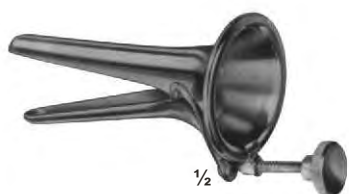

12-101
COLLIN
for children
53 x 10 mm

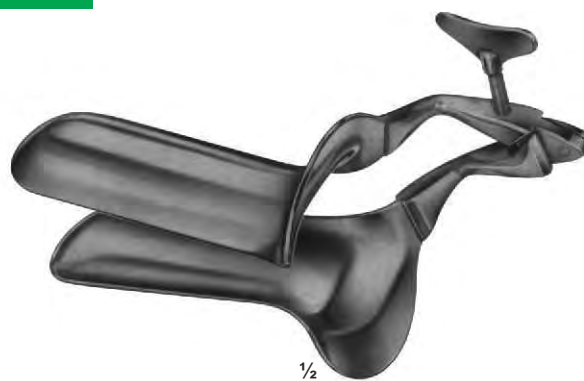

12-102 - 105
COLLIN

12-102	100/90mm	28 mm
12-103	100/90mm	32 mm
12-104	105/95mm	35 mm
12-105	115/105mm	40 mm
Total length/working length		width



12-106
COLLIN
for virgins
95/85 x 18 mm



12-107
CUSCO
for virgins
75 x 17 mm



12-108
CUSCO
for virgins
75 x 17 mm

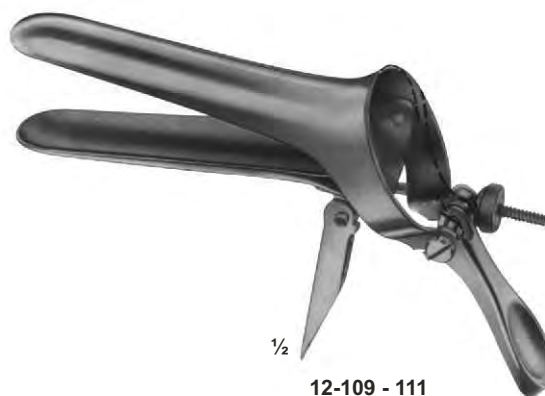

12-109 - 111
CUSCO

12-109	92X23-25 mm
12-110	100x25-27 mm
12-111	110x27-30 mm

Vaginal Specula

REALSTAR SURGICAL INSTRUMENTS



12-112 - 115
CUSCO
STANDARD
12-112 80X24 mm
12-113 80X32 mm
12-114 90X36 mm
12-115 110X37 mm



12-116 - 119
CUSCO
12-116 80X24 mm
12-117 80X32 mm
12-118 90X36 mm
12-119 110X37 mm



12-120 - 122
CUSCO
12-120 80X24 mm
12-121 80X32 mm
12-122 115X36 mm



12-123 - 124
SEYFFERT
12-123 100X24 mm
12-124 110X32 mm
230 mm



12-125
SEMM
for children
and virgins
180 mm

Vaginal Specula, Sets, Upper & Lower Blades

REALSTAR SURGICAL INSTRUMENTS



12-126 - 128
GRAVE
12-126 75X20 mm
12-127 95X30 mm
12-128 105X33 mm

1/2



12-129 - 130
PEDERSON
12-129 100X22 mm
12-130 120X25 mm

1/2



12-131 - 132
BRIESKY
12-131 72X25 mm / 77X30 mm
12-132 75X30 mm / 92X38 mm
170 mm

1/2



1/2

12-133 - 134
BRIESKY
12-133 100X22 mm
77 X30 mm
140 mm
12-134 120X25 mm
92 X38 mm



1/2

12-135 - 137
SEIDL
12-135 80X8 mm
12-136 80X10 mm
12-137 90X14 mm
For children and infants
170 mm



1/2

12-138
KRISTELLER
70X15 mm, (170 mm)
For children



1/2

12-139 - 141
SIMS
12-139 70X26 mm
75 X30 mm 125 mm
12-140 75X30 mm
80 X85 mm 150 mm
11-141 80X36 mm
90 X40 mm 175 mm

Vaginal Specula-Sets, upper and lower blades

REALSTAR SURGICAL INSTRUMENTS

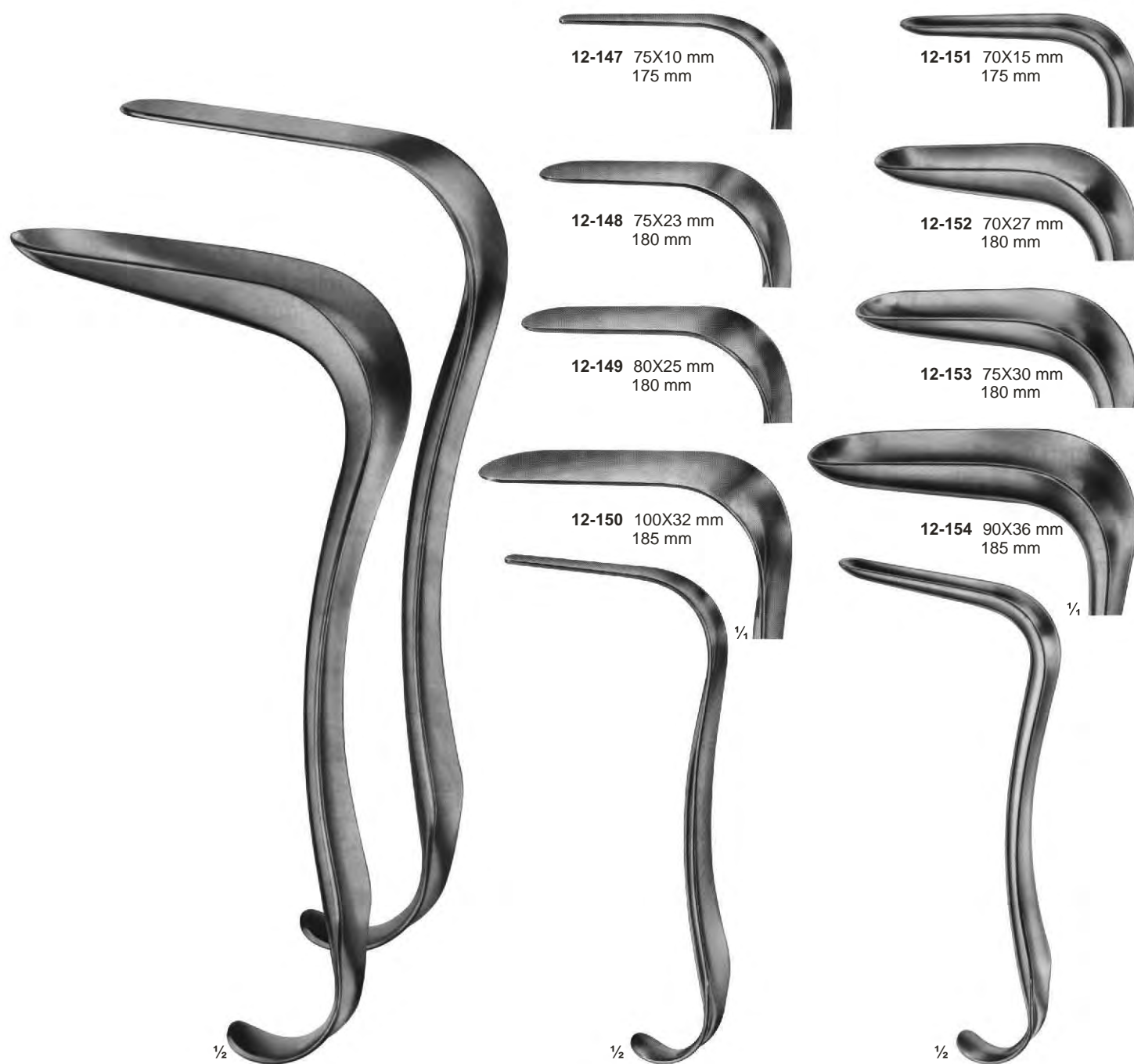

12-147 75X10 mm
175 mm

12-151 70X15 mm
175 mm

12-148 75X23 mm
180 mm

12-152 70X27 mm
180 mm

12-149 80X25 mm
180 mm

12-153 75X30 mm
180 mm

12-150 100X32 mm
185 mm

12-154 90X36 mm
185 mm

12-142 - 146
KRISTELLER
12-142 110X18 mm
12-143 110X20 mm
12-144 110X27 mm
12-145 110X30 mm
12-146 110X36 mm
220 mm

12-147 - 150
KRISTELLER
Upper blades

12-151 - 154
KRISTELLER
Lower blades

Vaginal Specula-upper and lower blades

REALSTAR SURGICAL INSTRUMENTS

12-155 115X14 mm
215 mm

12-156 115X23 mm
215 mm

12-157 115X16 mm
220 mm

12-158 115X26 mm
220 mm

12-159 120X30 mm
225 mm

12-160 110X18 mm
215 mm

12-161 110X27 mm
215 mm

12-162 110X20 mm
220 mm

12-163 110X30 mm
220 mm

12-164 110X36 mm
225 mm

12-155 - 159
KRISTELLER
Upper blades

12-160 - 164
KRISTELLER
Lower blades

Vaginal Specula

REALSTAR SURGICAL INSTRUMENTS



Vaginal Specula-for children & virgins / Vario Retractor

**REALSTAR SURGICAL
INSTRUMENTS**



95 x 17 - 30 mm

**12-173
MATHIEU**
For children
and virgins
210 mm

1/2



56 x 13 mm

1/2

**12-171
BRAUN**
180 mm



60 x 10 mm

1/2

**12-172
BRAUN**
180 mm



12-175
Handle with cold light
carrier for upper blades
280 mm

1/2



95 x 17-26 mm

1/2

**12-174
MATHIEU**
for children and
virgins fitting
210 mm

Vaginal Specula-for children and virgins

REALSTAR SURGICAL INSTRUMENTS



12-176
60 X 45 mm

12-177
90 X 45 mm

12-178
112 X 45 mm

12-176 - 178
DOYEN
235 mm

12-179 - 189

Length of blades		Width of blades		
60 mm	35 mm	45 mm	60 mm	
90 mm	12-179	12-182	12-186	
120 mm	12-180	12-183	12-187	
160 mm	12-181	12-184	12-188	
		12-185	12-189	



12-190 - 194
BREISKY
WIENER MODELL/
VIENNA PATTERN
12-190 100 X 20 mm
12-191 100 X 25 mm
12-192 100 X 30 mm
12-193 100 X 35 mm
12-194 100 X 40 mm
300 mm

12-195 - 199
BREISKY
WIENER MODELL/
VIENNA PATTERN
12-195 130 X 20 mm
12-196 130 X 25 mm
12-197 130 X 30 mm
12-198 130 X 35 mm
12-199 130 X 40 mm
320 mm

12-200 - 201
WEISSBARTH
12-200 80 X 28 mm
12-201 85 X 42 mm
210 mm

12-202
DOYEN
lateral speculum
80 x 30 mm
250 mm

Vaginal & Wound Retractor / Vaginal Specula

REALSTAR SURGICAL INSTRUMENTS



12-203
SIMON
115 X 22 mm
275 mm



12-204
AUVARD
65 X 38 mm - 28 mm
1,530 kg
with fixed weight
230 mm



12-205 - 206
AUVARD
12-205 75 X 42 mm
(40 mm)
12-206 105 X 43 mm
(40 mm)
with detachable wight
230 mm



12-207
MARTIN
with hook shaped
handle for hanging
in weights
270 mm

Vaginal Speculas

REALSTAR SURGICAL INSTRUMENTS

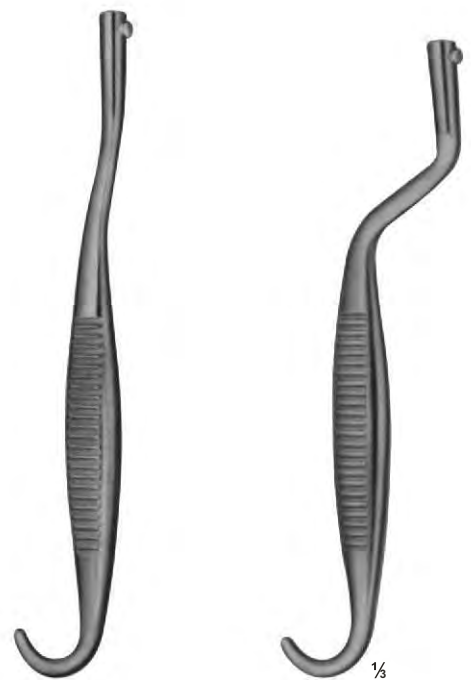
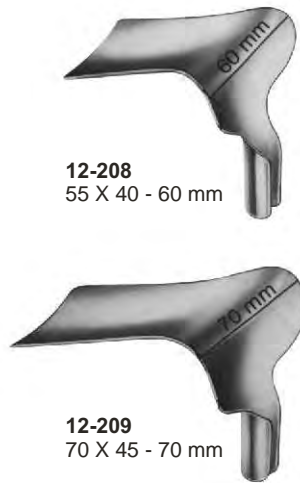

Vaginal Retractors

REALSTAR SURGICAL INSTRUMENTS



12-221
JOLL (FRIEDMAN)
155 mm



12-222
RICHTER
170 mm



12-223
GELPI
135 mm



12-224
GELPI
175 mm

Uterine Dilators

REALSTAR SURGICAL INSTRUMENTS



13-101 - 143
HEGAR
with very conical point
185 mm

13-101	1	mm	13-123	23	mm
13-102	2	mm	13-124	24	mm
13-103	3	mm	13-125	25	mm
13-104	4	mm	13-126	26	mm
13-105	5	mm	13-127	1	½mm
13-106	6	mm	13-128	2	½mm
13-107	7	mm	13-129	3	½mm
13-108	8	mm	13-130	4	½mm
13-109	9	mm	13-131	5	½mm
13-110	10	mm	13-132	6	½mm
13-111	11	mm	13-133	7	½mm
13-112	12	mm	13-134	8	½mm
13-113	13	mm	13-135	9	½mm
13-114	14	mm	13-136	10	½mm
13-115	15	mm	13-137	11	½mm
13-116	16	mm	13-138	12	½mm
13-117	17	mm	13-139	13	½mm
13-118	18	mm	13-140	14	½mm
13-119	19	mm	13-141	15	½mm
13-120	20	mm	13-142	16	½mm
13-121	21	mm	13-143	17	½mm
13-122	22	mm			



13-144 - 152
HEGAR
205 mm

13-144	1+2	mm
13-145	3+4	mm
13-146	5+6	mm
13-147	7+8	mm
13-148	9+10	mm
13-149	11+12	mm
13-150	13+14	mm
13-151	15+16	mm
13-152	17+18	mm

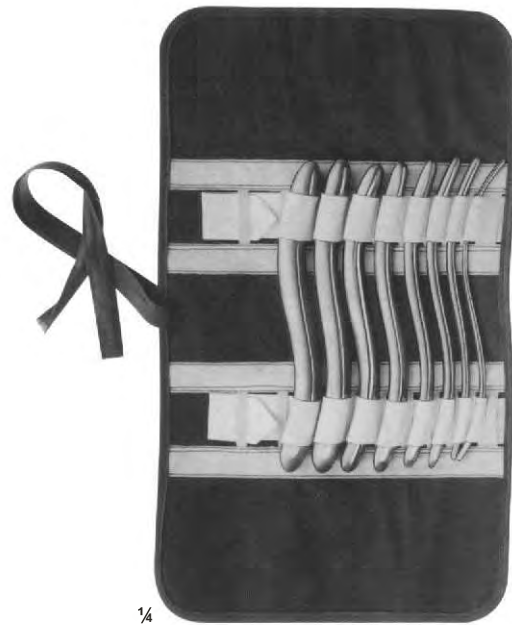

13-153
HEGAR
Uterine dilator set, in canvas
roll with 8 dilators.

Uterine Dilators - Complete Sets

**REALSTAR SURGICAL
INSTRUMENTS**



13-154
HEGAR
Dilator set consisting of:
14 Dilators,
1 Rack for dilators (4 - 12 mm)
1 Rack for Dilators (13 - 17 mm)
1 Metal case only,
with hinged lid, stainless 200 X 100 X 35 mm

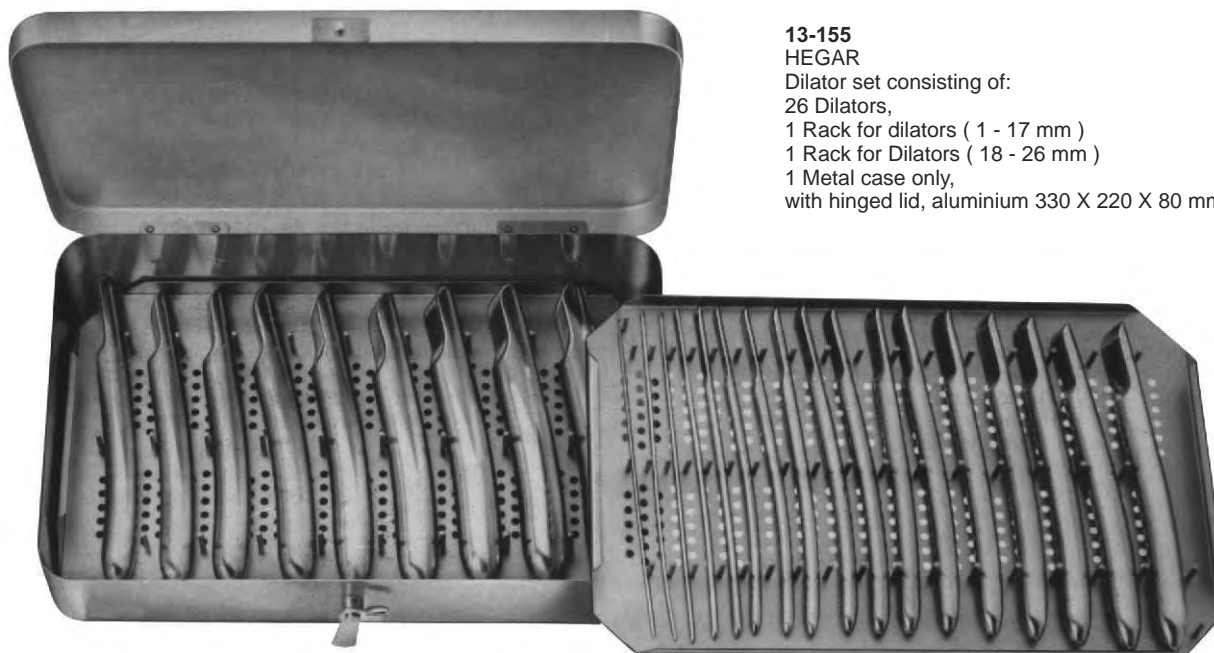

13-155
HEGAR
Dilator set consisting of:
26 Dilators,
1 Rack for dilators (1 - 17 mm)
1 Rack for Dilators (18 - 26 mm)
1 Metal case only,
with hinged lid, aluminium 330 X 220 X 80 mm

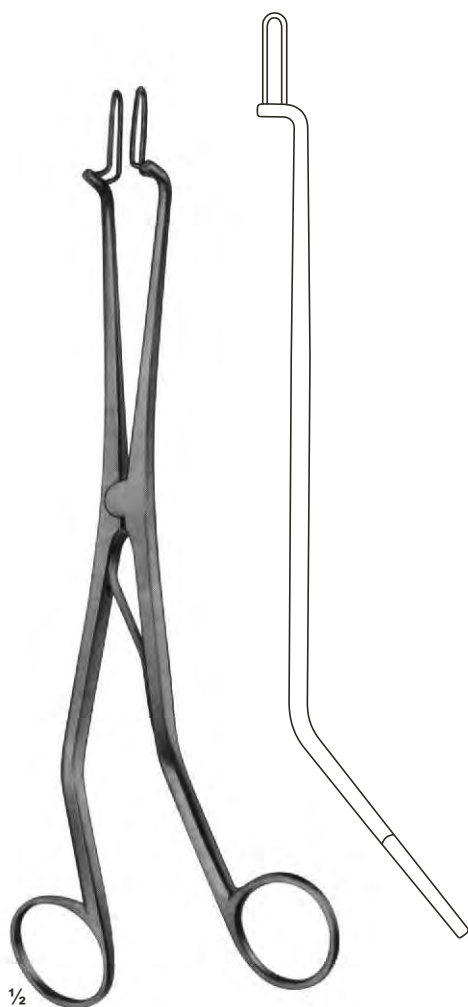

13-156
KOGAN
Endospecula for cervix
and urethra, without ratchet
240 mm



13-157
KOGAN
Endospecula for cervix
and urethra, with
scale-ratchet and fixing screws
240 mm

Uterine Probes

REALSTAR SURGICAL INSTRUMENTS



14-101
MAYO
biegsam malleable
330 mm



14-102
SIMS
biegsam malleable
330 mm



14-103
MARTIN
330 mm



14-104
SIMPSON
malleable
silver-plated
290 mm



14-105
BRAUN
Uterine
depressor
270 mm



14-106
Cotton
applicator
270 mm

Uterine Dressing Forceps

REALSTAR SURGICAL INSTRUMENTS



14-107
PELKMANN
260 mm

14-108
PELKMANN
260 mm

14-109
BOZEMANN
250 mm

14-110
BOZEMANN
255 mm

Jaws with longitudinal groove

Uterine Dressing Forceps

REALSTAR SURGICAL INSTRUMENTS

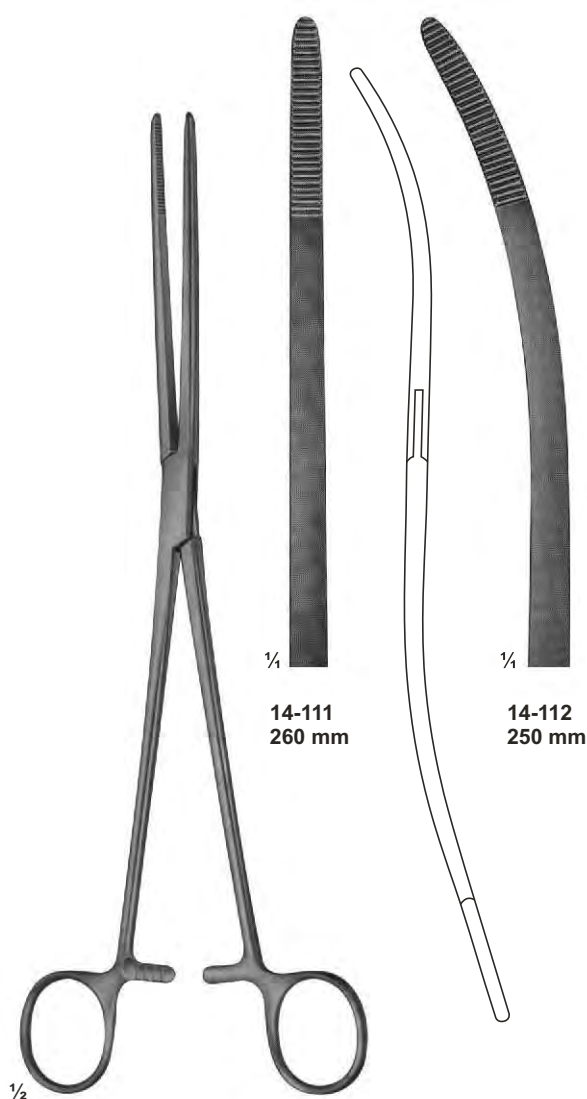

14-111 - 112
BOZEMANN

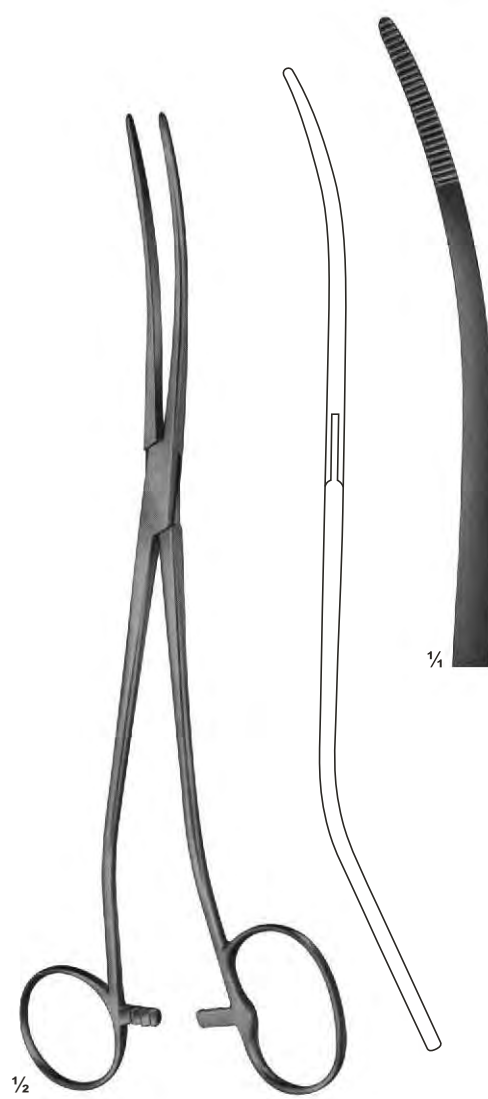

14-113
BOZEMANN-DOUGLAS
260 mm

Uterine Tenaculum Forceps

REALSTAR SURGICAL INSTRUMENTS



14-114
BRAUN
slender type
250 mm



14-115
SCHRODER
250 mm



14-116
POZZI
heavy type
255 mm

Uterine Tenaculum Forceps

REALSTAR SURGICAL INSTRUMENTS



14-117
265 mm

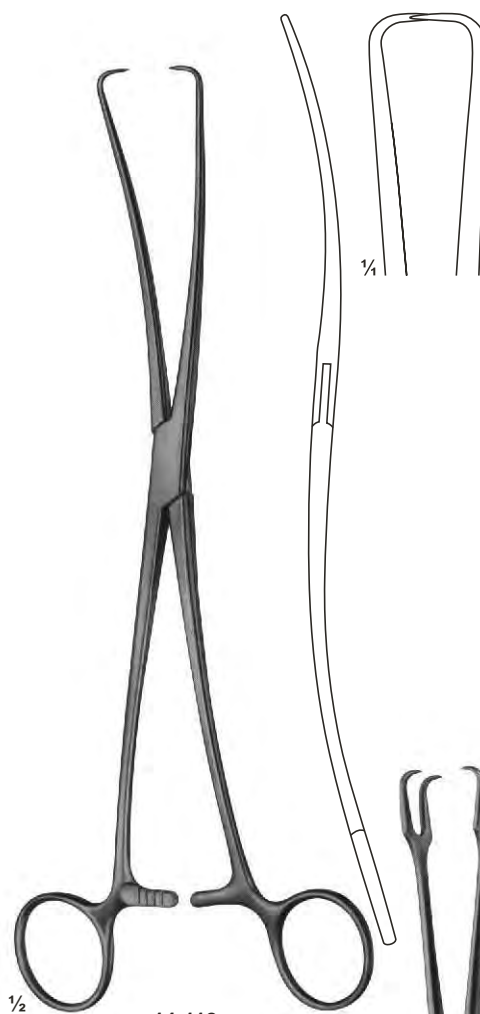
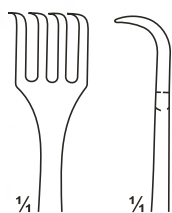

14-118
DUPLAY
250 mm

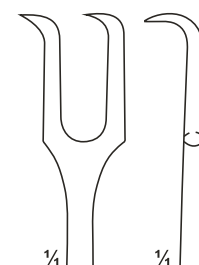

14-119
LAHEY
155 mm

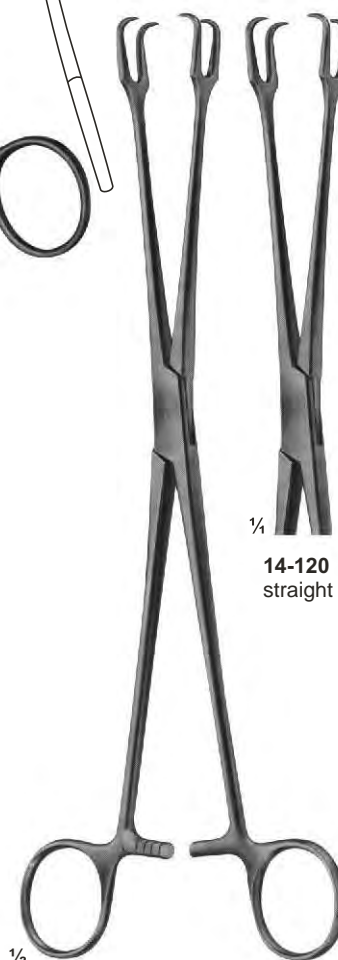

14-120 - 122
SCHRODER
250 mm



14-120
straight



14-121
curved
on flat



14-122
curved
sideways

Uterine Tenaculum Forceps

**REALSTAR SURGICAL
INSTRUMENTS**

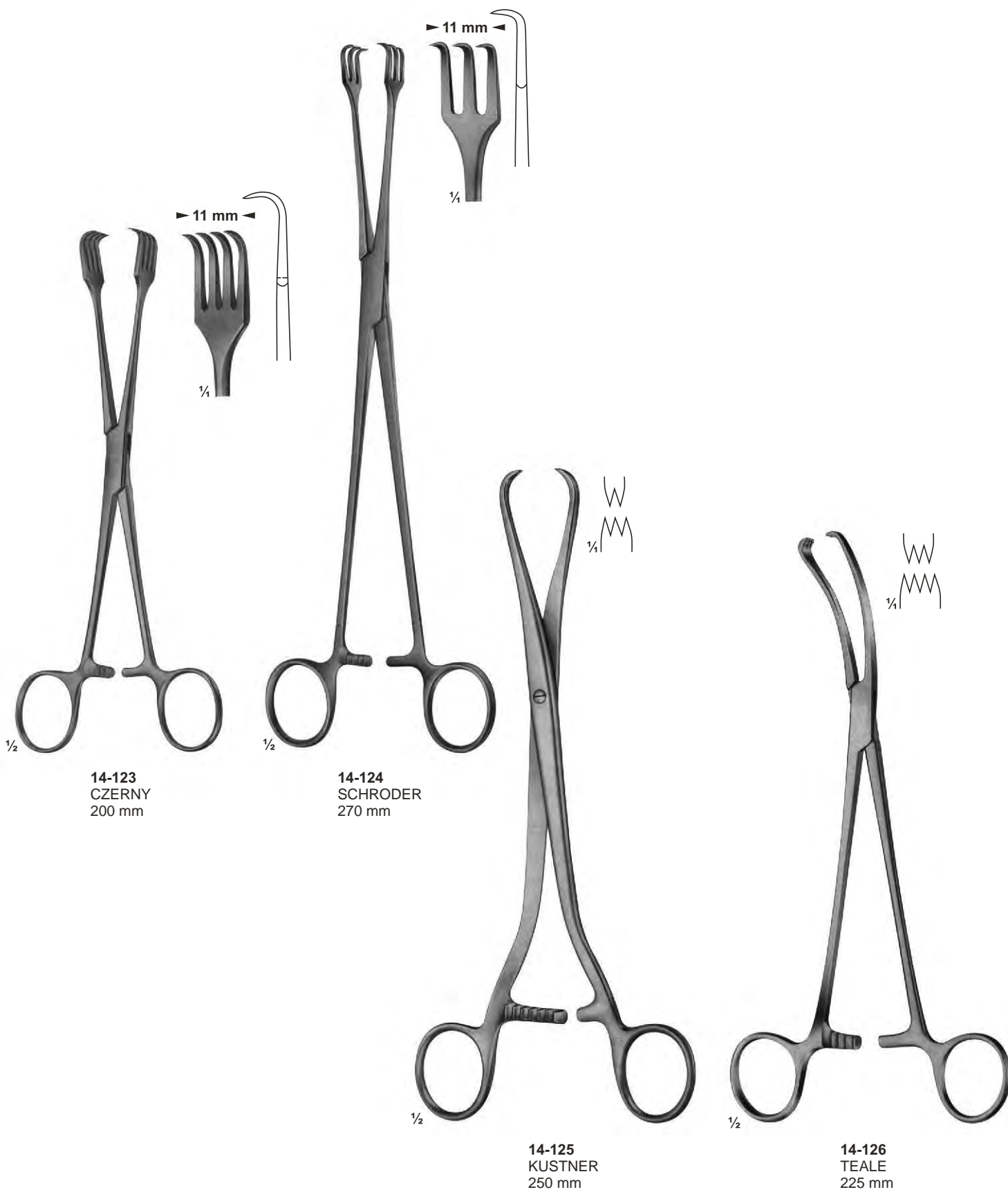

**REALSTAR SURGICAL
INSTRUMENTS**

SERVING TO SAVE LIVES

Uterine Tenaculum Forceps

REALSTAR SURGICAL INSTRUMENTS

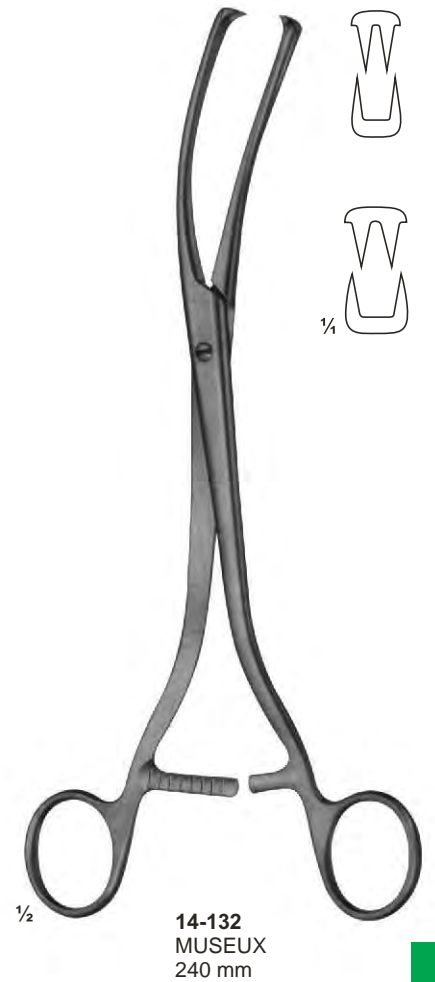
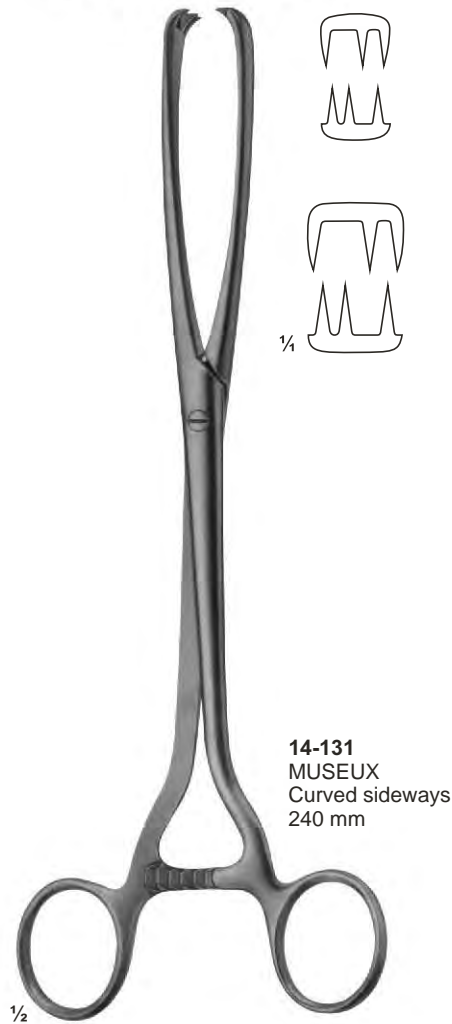
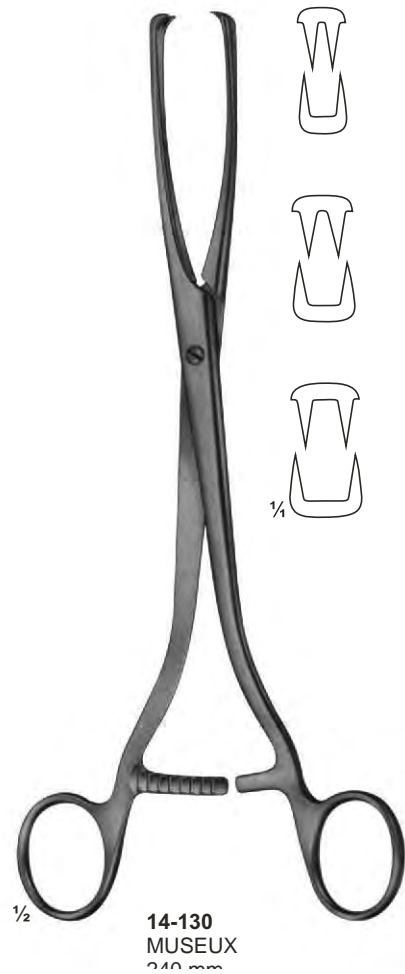

Polypus-and Ovum Forceps

**REALSTAR SURGICAL
INSTRUMENTS**

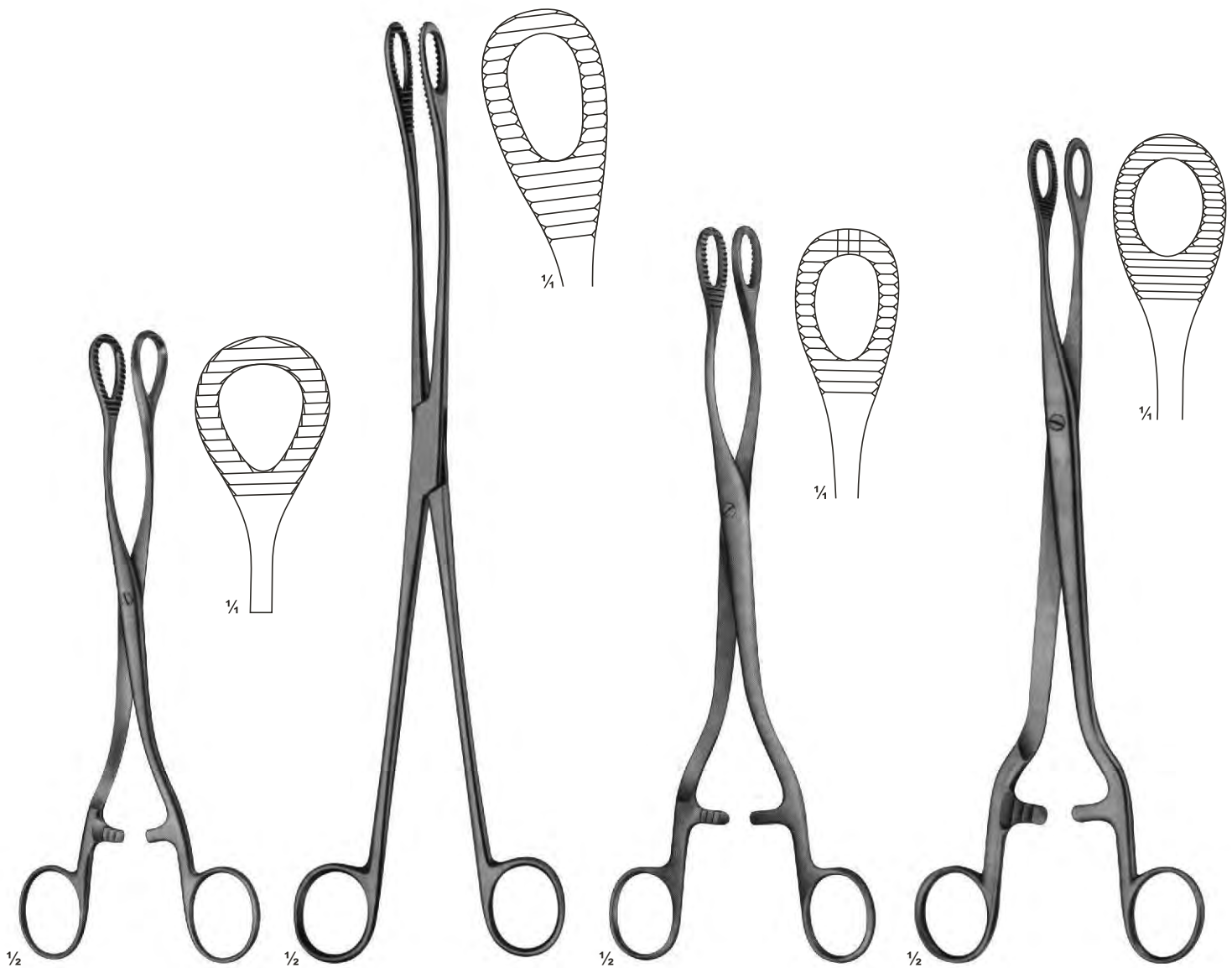

14-133
HEYWOOD-SMITH
200 mm

14-134
KELLY
320 mm

14-135
HEYWOOD-SMITH
250 mm

14-136
NOTO
280 mm

Polypus and Ovum Forceps

REALSTAR SURGICAL INSTRUMENTS



1/4



1/4

14-138

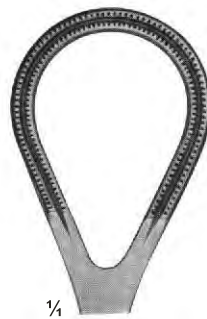

1/4

14-139



1/4



1/2

14-137
DOYEN
185 mm



1/2

14-138 - 139
250 mm 270 mm



1/2

14-140
BUMM
280 mm

Uterine Elevating Forceps

REALSTAR SURGICAL INSTRUMENTS

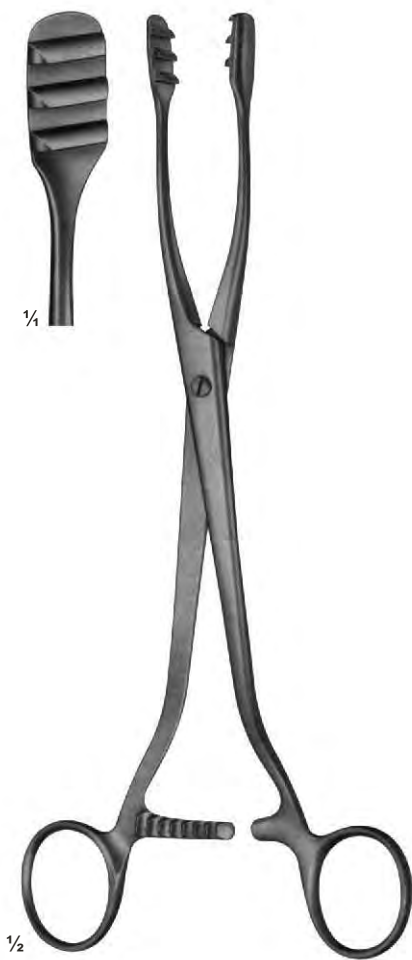

14-141
COLLIN
250 mm



14-142
COLLIN
285 mm



14-143
DARTIGUES
255 mm

Uterine Elevating Forceps

**REALSTAR SURGICAL
INSTRUMENTS**



**14-144
SOMER**
235 mm



**14-145
STRASSMANN**
260 mm

**REALSTAR SURGICAL
INSTRUMENTS**

SERVING TO SAVE LIVES

232

Gali Shah Khaki Wali Kashmir Street,
Rang Pura Road, Sialkot 51310-Pakistan
Phone: +92 3348033729
Fax: +92 52 4570067
E-mail: info@Realstarsurgical.com
Website: www.Realstarsurgical.com

Uterine Elevating Forceps

**REALSTAR SURGICAL
INSTRUMENTS**

With movable jaws



**14-146
COLLIN
265 mm**

With movable jaws



**14-147
260 mm**

Myoma Instruments

REALSTAR SURGICAL INSTRUMENTS



14-148
SEGOND
Myomatome
270 mm



14-149
DOYEN
Myoma screw
150 mm



14-150
DOYEN
Myoma screw
190 mm



14-151 - 153
NEUBUSER
Tubal seizing forceps
200 mm

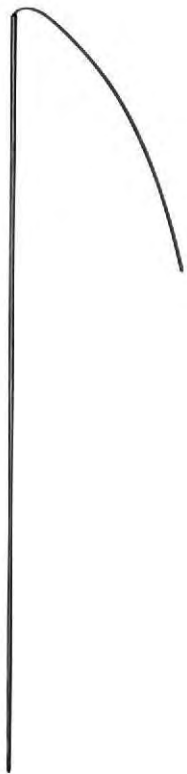

14-154
Splint guide
with thread



14-155
Splint guide with
round handle



14-156
Angled glass rods
Set . 3 pieces



14-157
Silicon operating pad
pre-cut



14-158
Polyethylene splint material
soft-sterile
0.45 mm

Biopsy Curettes

REALSTAR SURGICAL INSTRUMENTS

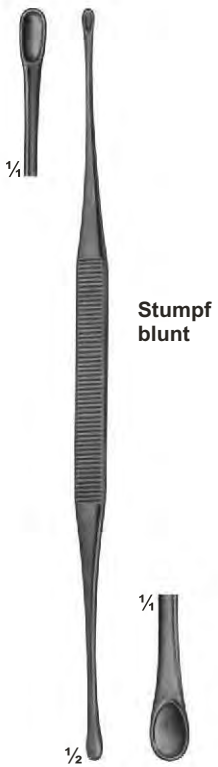

15-101
ASCH
Uterine
Secretion scoop
200 mm

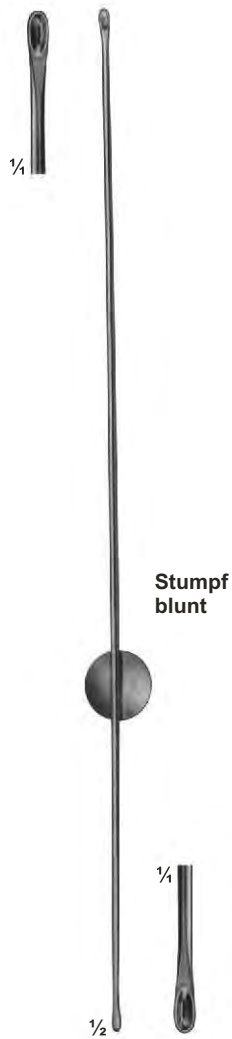

15-102
Uterine
Secretion scoop
270 mm



15-103
NOVAK-SCHOECKAERT
Endometrial biopsy
curette
240 mm



15-104
RANDALL
Endometrial biopsy
curette
240 mm

Biopsy Forceps

REALSTAR SURGICAL INSTRUMENTS

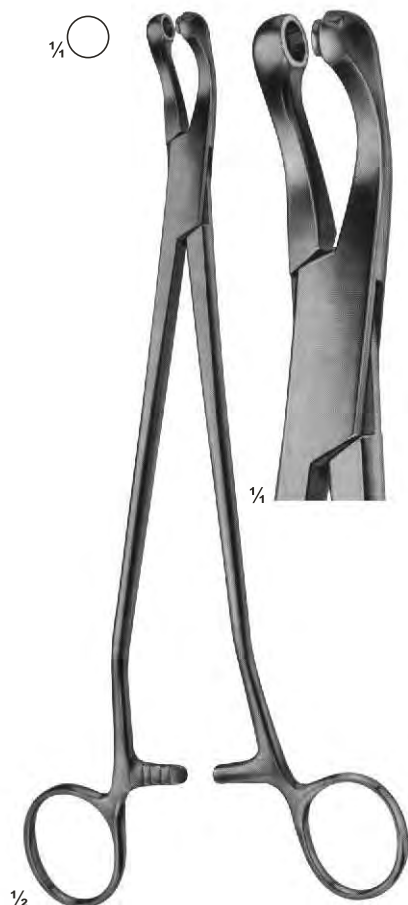

15-105
THOMS-GAYLOR
240 mm



15-106
SCHUBERT
260 mm

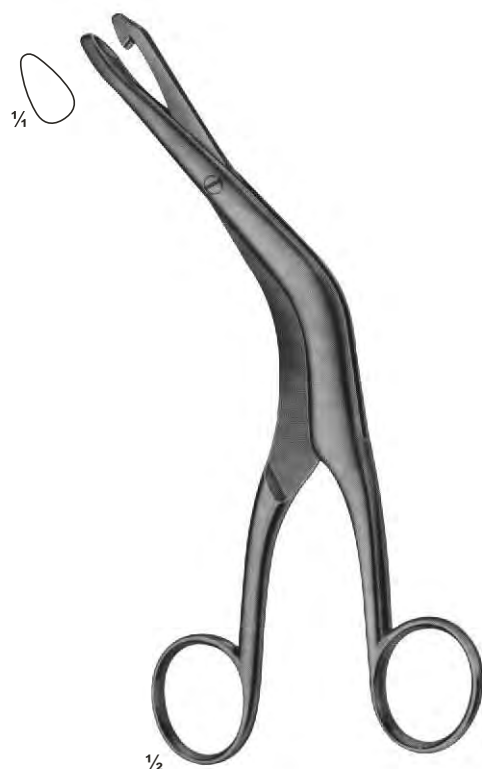

15-107
FAURE
210 mm

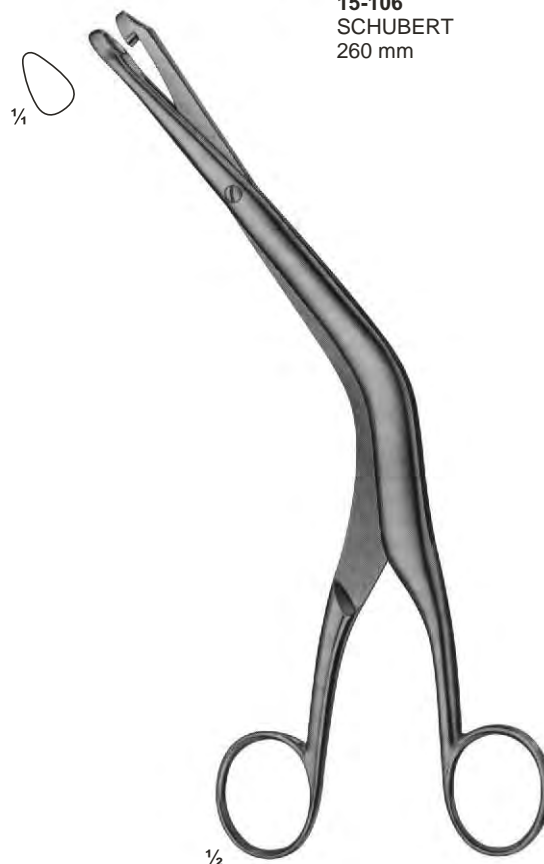

15-108
FAURE
240 mm

Biopsy Forceps

REALSTAR SURGICAL INSTRUMENTS

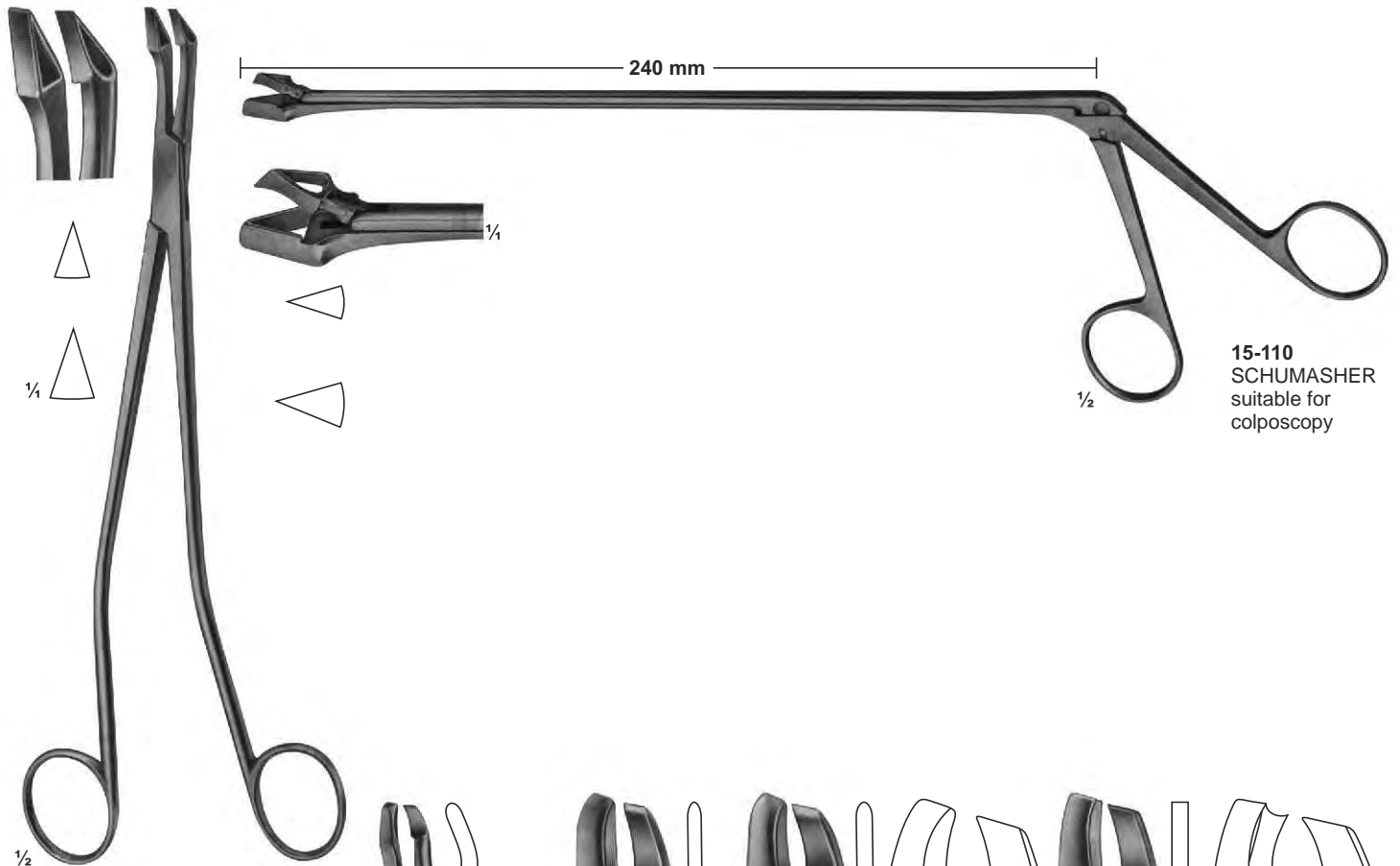

15-110
SCHUMASHER
suitable for
colposcopy

15-109
SCHUMASHER
240mm

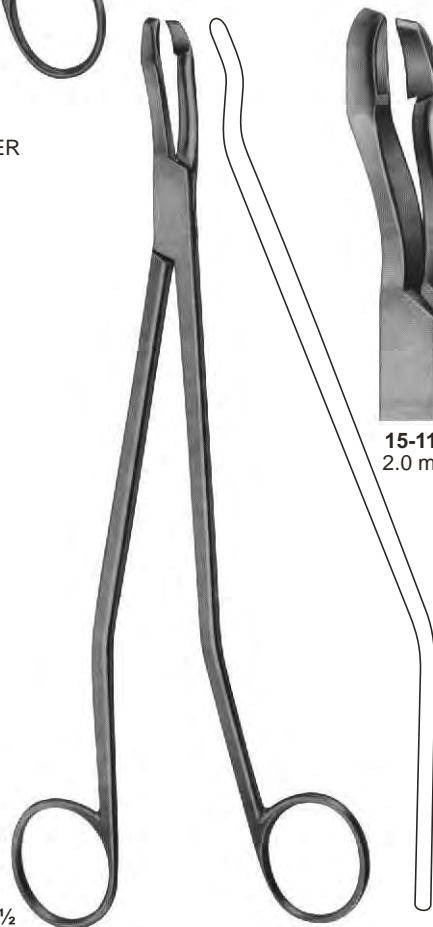

15-111 - 113
SEIDL DBP
Biopsy forceps, bayonet shaped
for portio, vagina and vulva
240mm



15-111
2.0 mm



15-112
2.4 mm



15-113
2.4 mm

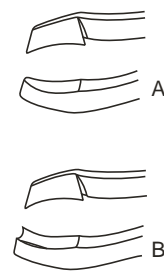

Biopsy Forceps

REALSTAR SURGICAL INSTRUMENTS

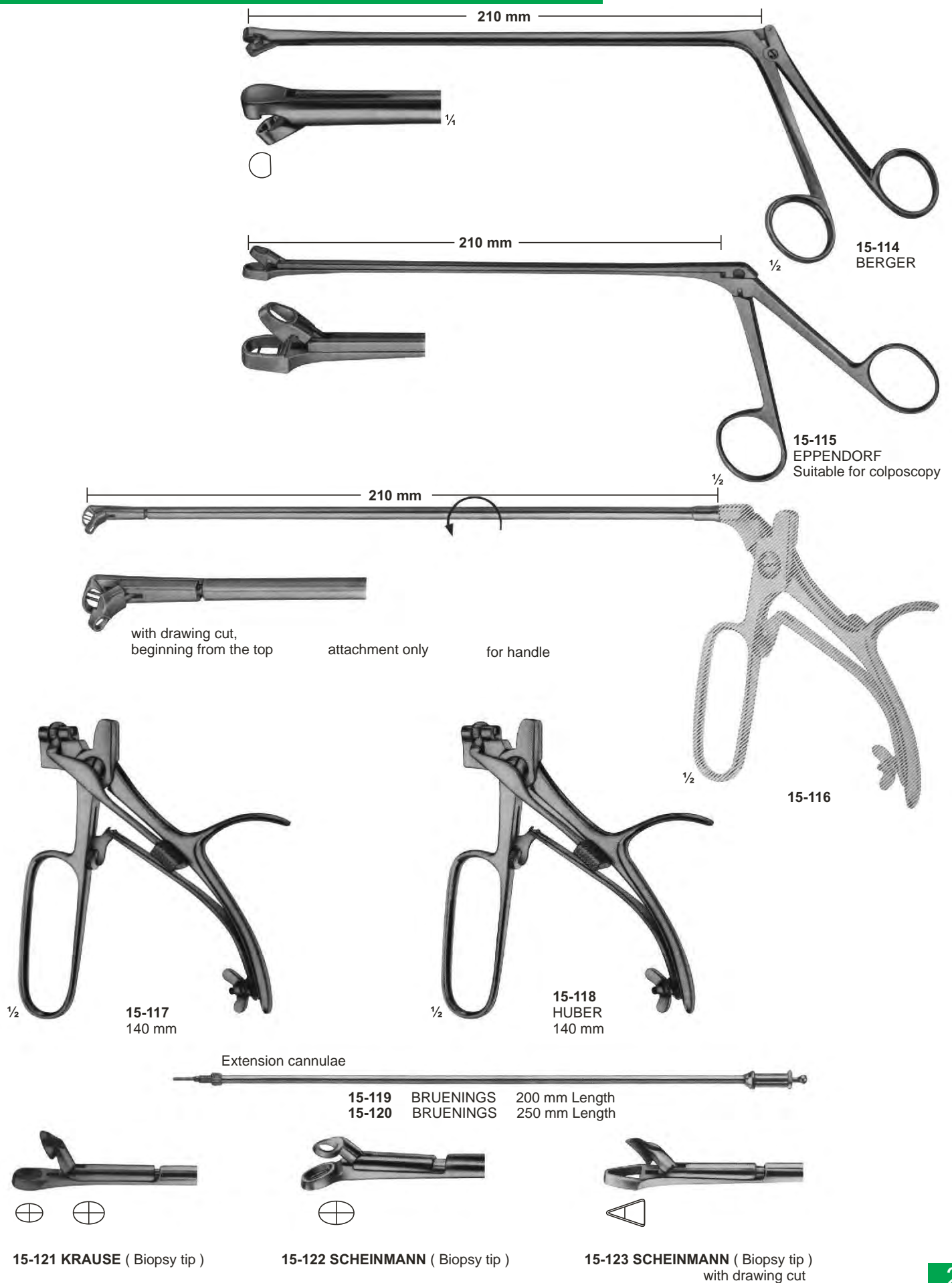

Uterine Scoops

REALSTAR SURGICAL INSTRUMENTS

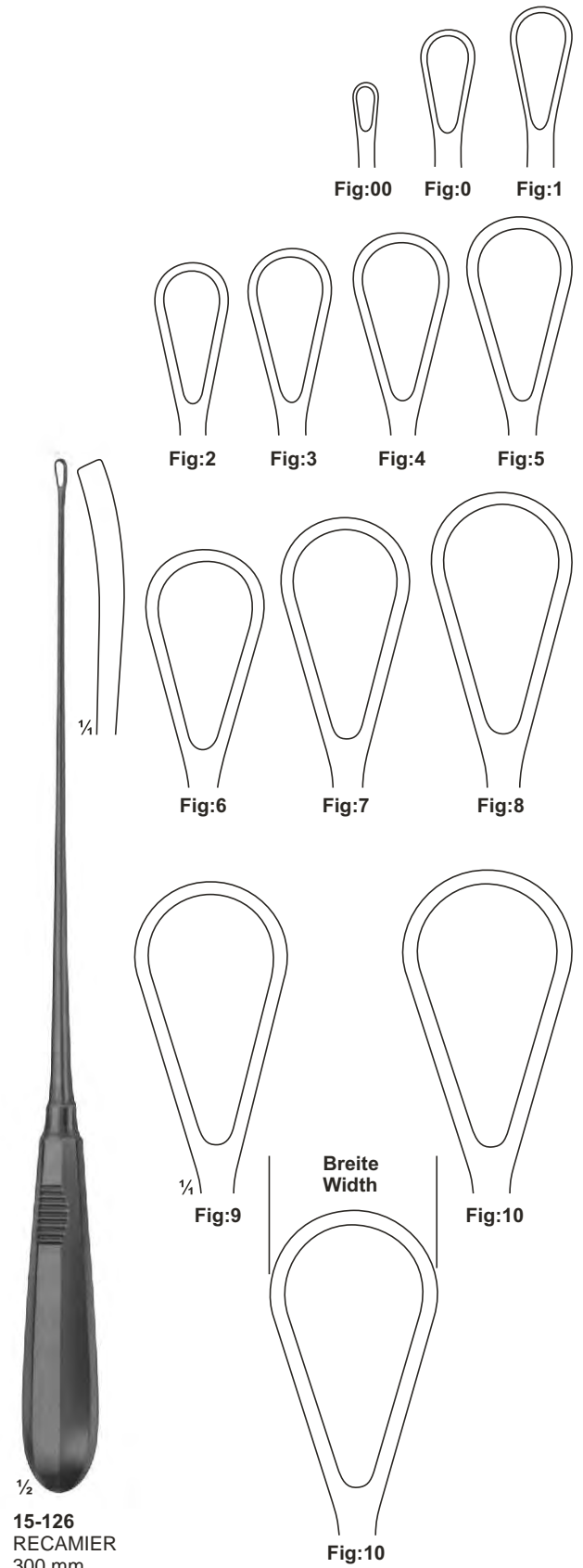
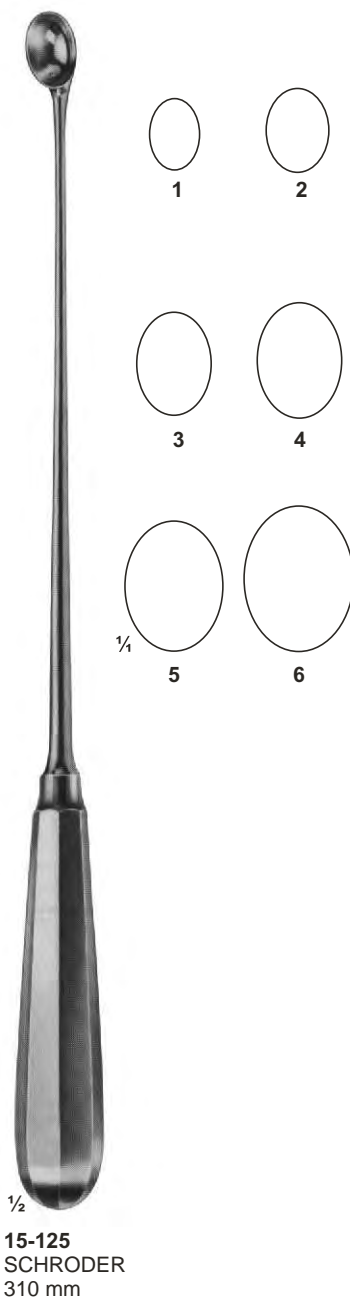
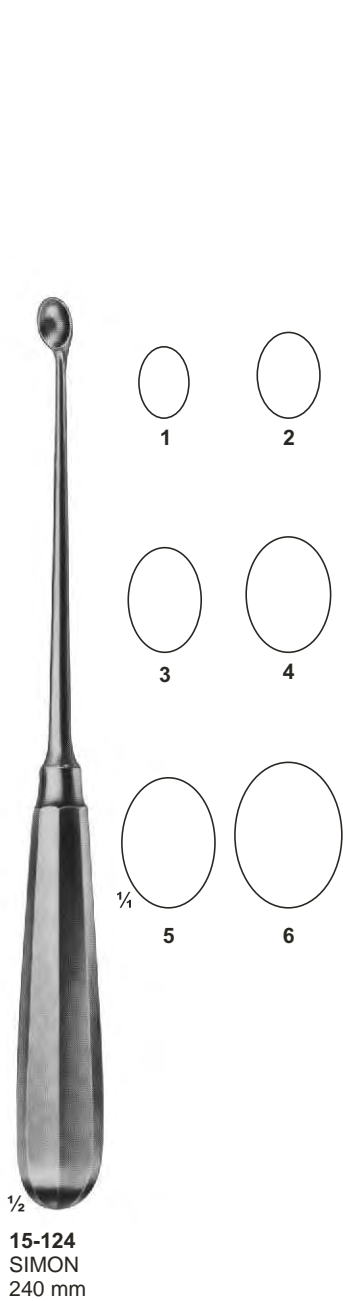

Uterine Curettes

REALSTAR SURGICAL INSTRUMENTS

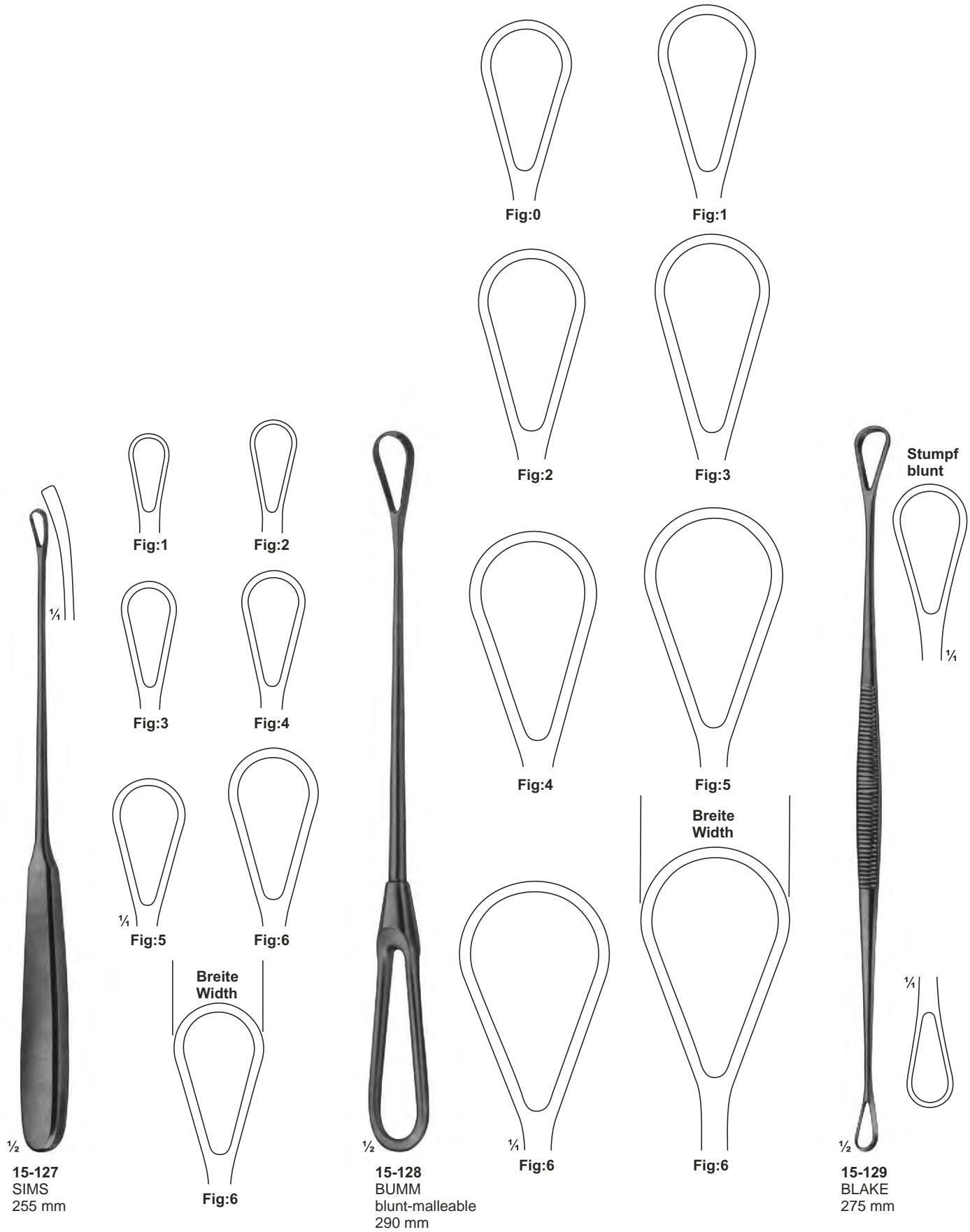

15-127
SIMS
255 mm

15-128
BUMM
blunt-malleable
290 mm

15-129
BLAKE
275 mm

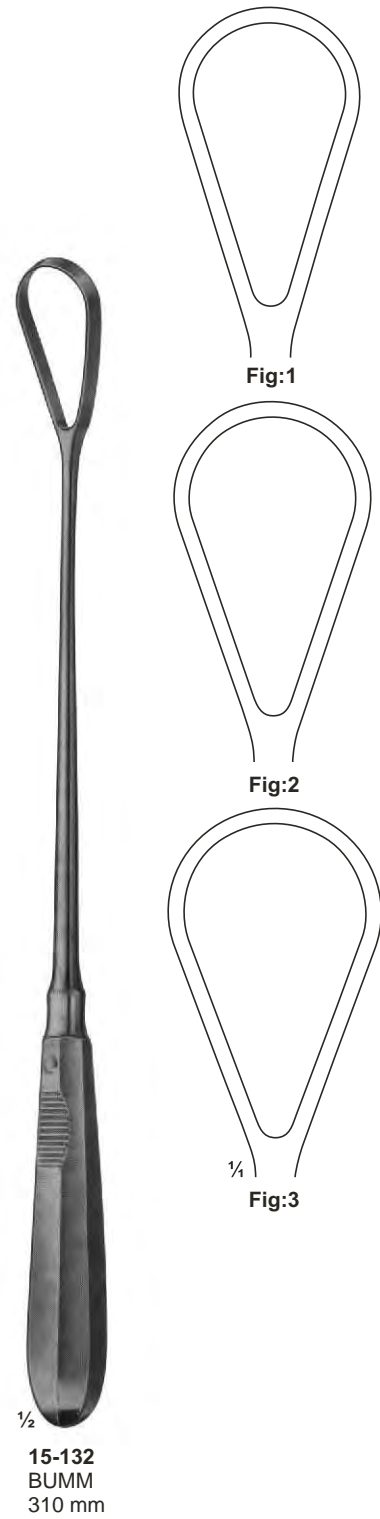
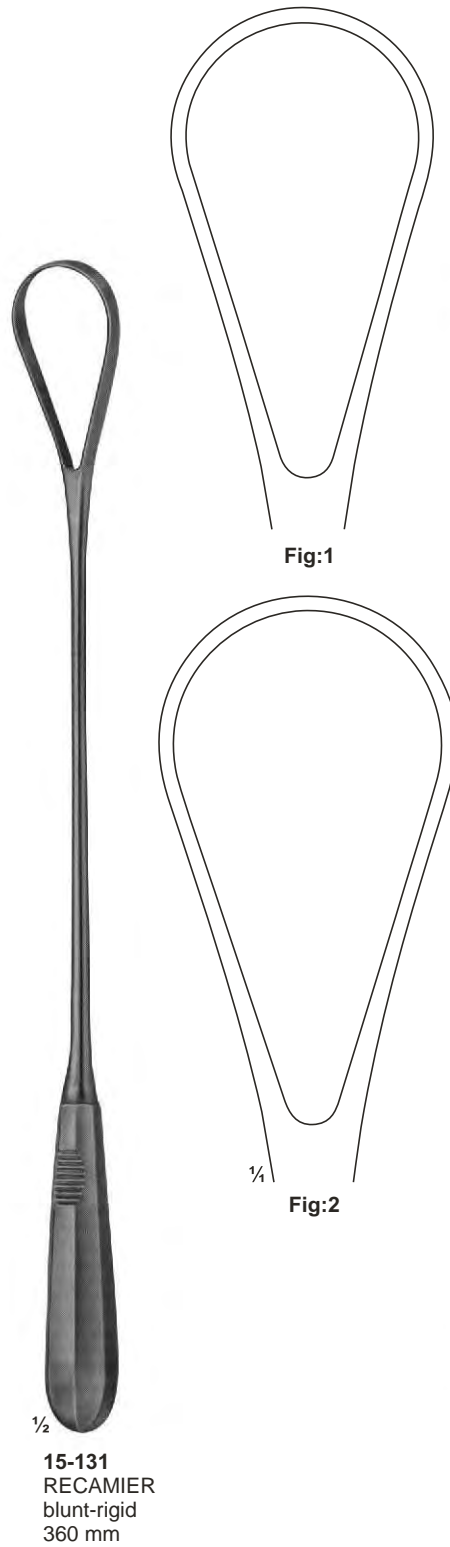

Vacuum Currettes

REALSTAR SURGICAL INSTRUMENTS

15-133 - 138

Suction currettes, stainless steel, fitting hose connection.

Working tips are smoothly rounded of, therefore no danger of perforation.



(suitable for suction biopsy)

- 15-133: diam 4 mm
- 15-134: diam 6 mm
- 15-135: diam 8 mm
- 15-136: diam 10 mm
- 15-137: diam 12 mm
- 15-138: diam 14 mm

15-139

Hose connection inside diam. 11 mm curved stainless steel.



15-140

The new connection between suction curette and hose connection, Guarantees quick changing and free turning of the suction currettes on the hose connection.

15-141

Transparent suction hose 1.8 m long, inside diam 11 mm, outside diam 16.5 mm can be sterilized in an autoclave at 1 bar overpressure (120 C)



15-142

Strainer for tissues, plastic, for single use only, to be used for histopathological examination.



15-143 diam 8 mm
15-144 diam 10 mm
BOZEMANN-FRITSCH
Uterine Flushing Tube
350 mm

1/2



15-145
SCHULZE
Salpingograph, for utero-salpingography
in wooden case, consisting of:
Manometer, Connection, Uterine canulla
with tap, Cone S.M.L.,
Record Syringe 10 cc, Luer lock mount.



15-146
SCHULZE
Salpingograph, equipment
without manometer.



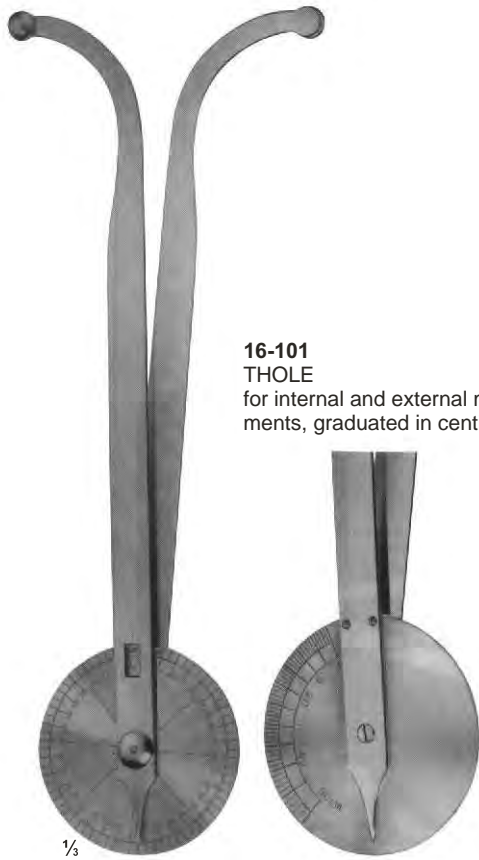

16-101
THOLE
for internal and external measurements, graduated in centimeters

1/3



1/2

16-102
DE LEE
graduated in centimeters and inches



1/3

16-103
COLLIN
graduated in centimeters



1/3

16-104
MARTIN
graduated in centimeters



1/3



for internal measurements between symphysis and promontory

16-105
COLLIN
graduated in centimeters

The additional straight arm can be replaced. The pelvimeter with straight arm is used for localisation of the portio vaginalis uteri and of vaginal metastasis.



1/3

16-106
BREISKY
graduated in centimeters

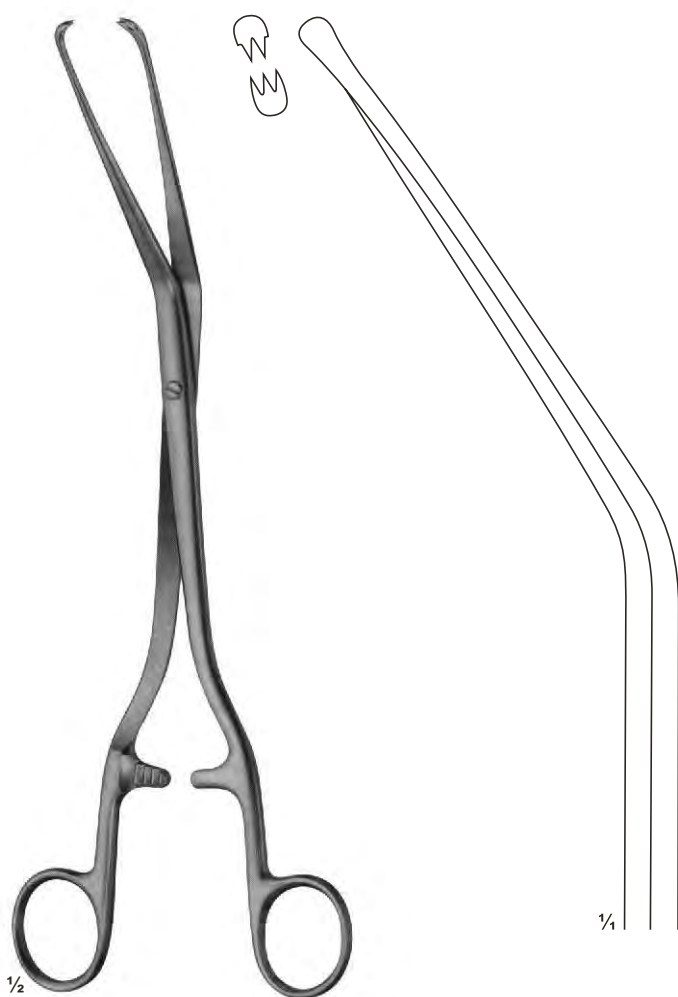

16-107
HERFF
puncturing forceps
225 mm



16-108
IOWA
puncturing forceps
260 mm

Scissors of Obstetrics, Umbilical cord clamp

REALSTAR SURGICAL INSTRUMENTS



16-109
SCHUMACHER
Umbilical cord
scissors
155 mm



16-110
Umbilical cord
scissors
105 mm

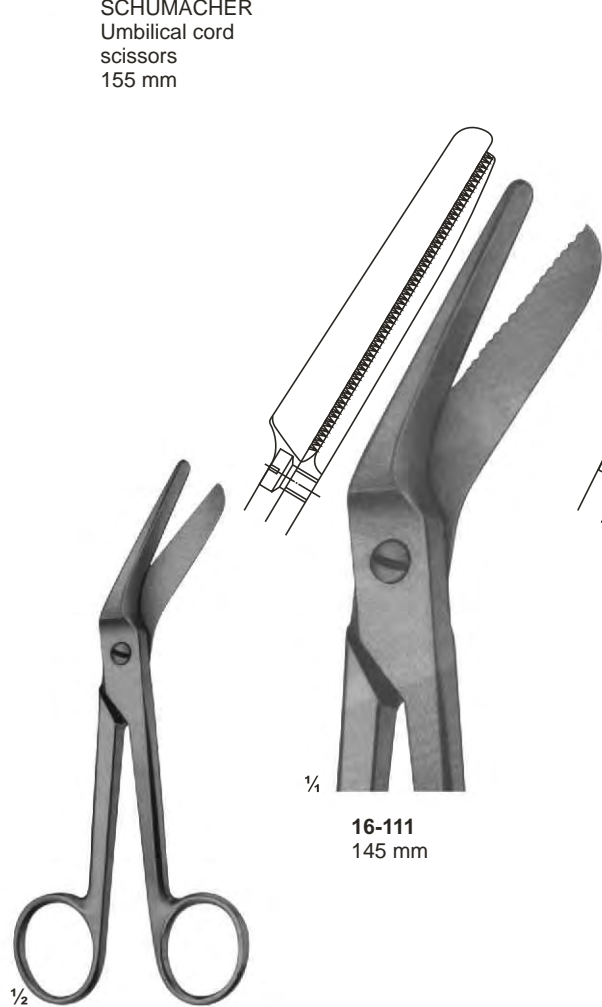

16-111
145 mm

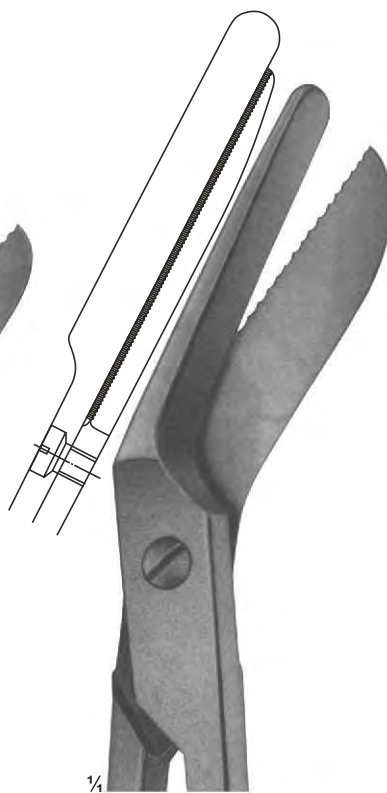

16-112
200 mm

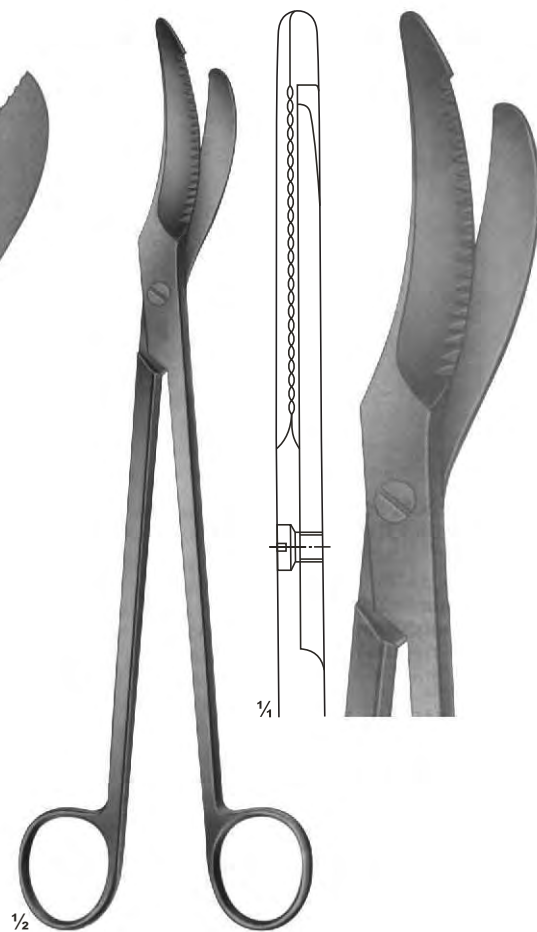

16-113
Episiotomy Scissors
240 mm

16-111 - 112
BRAUN-STADLER
Episiotomy Scissors



16-114
355 mm



16-115
400 mm



16-116
SIMPSON-BRAUN
305mm



16-117
SIMPSON-BRAUN
305mm



16-118
SIMPSON
235mm



16-119
WRIGLEY
250 mm

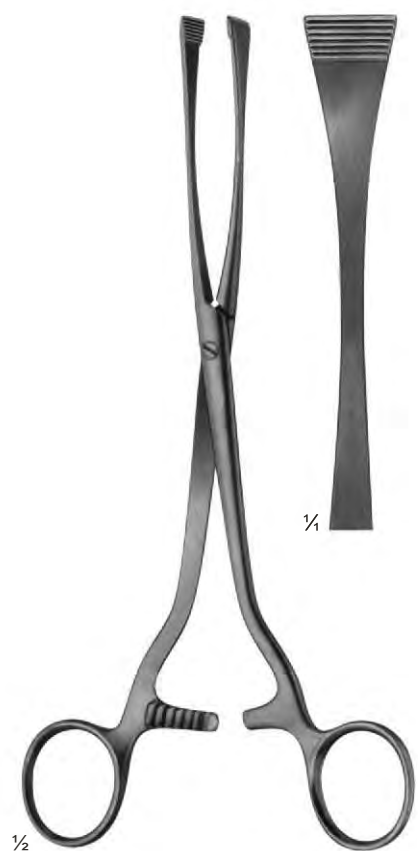

16-120
GREEN-ARMYTAGE
Caesarean section haemostatic forceps, for edges of the transverse incision in the lower segment
220 mm



16-121
WILLETT
Scalpel Flap forceps
185 mm



16-122
GAUSS
Scalpel Flap forceps
260 mm

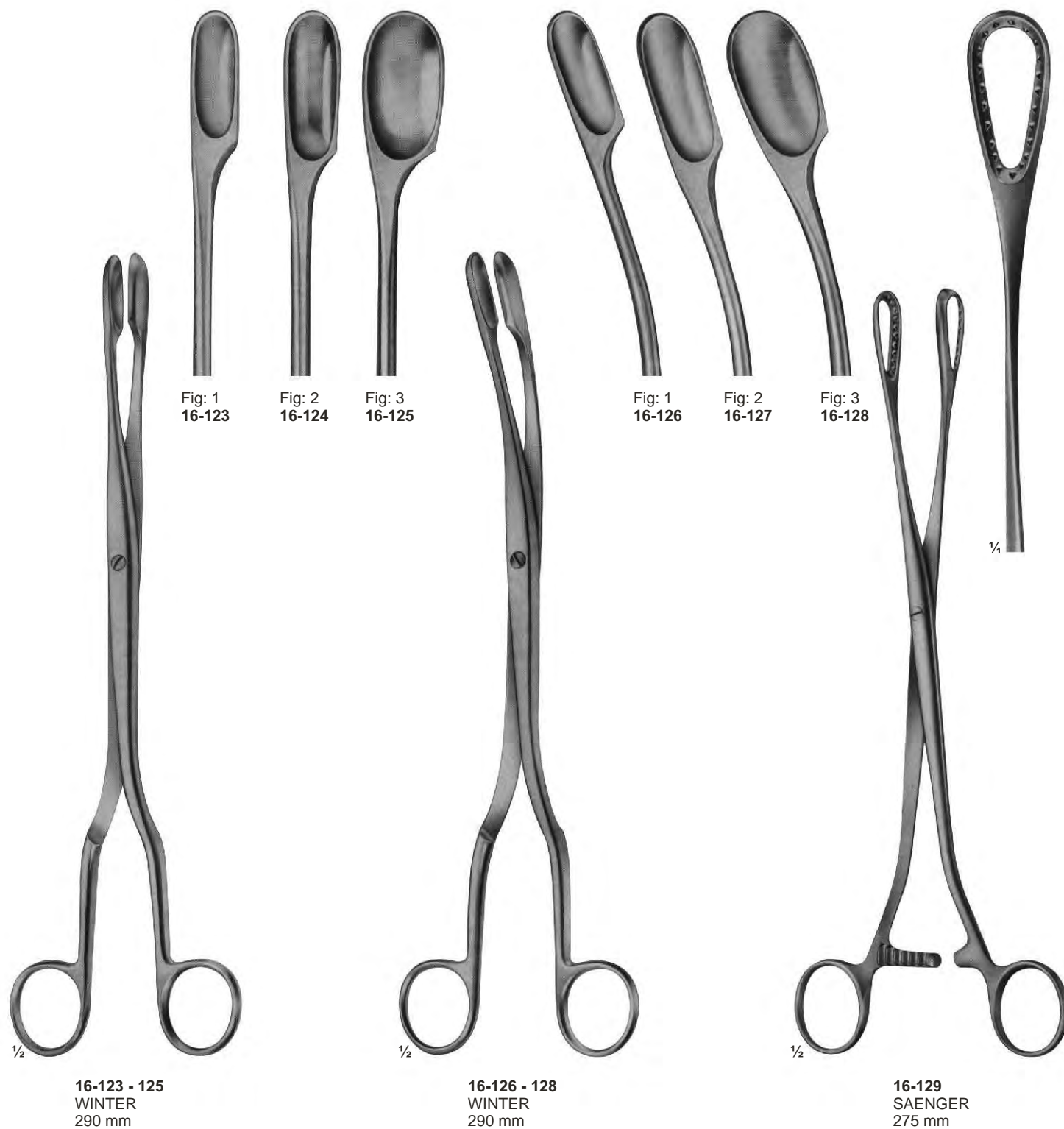

Obstetrics-Placenta and Ovum Forceps

REALSTAR SURGICAL INSTRUMENTS

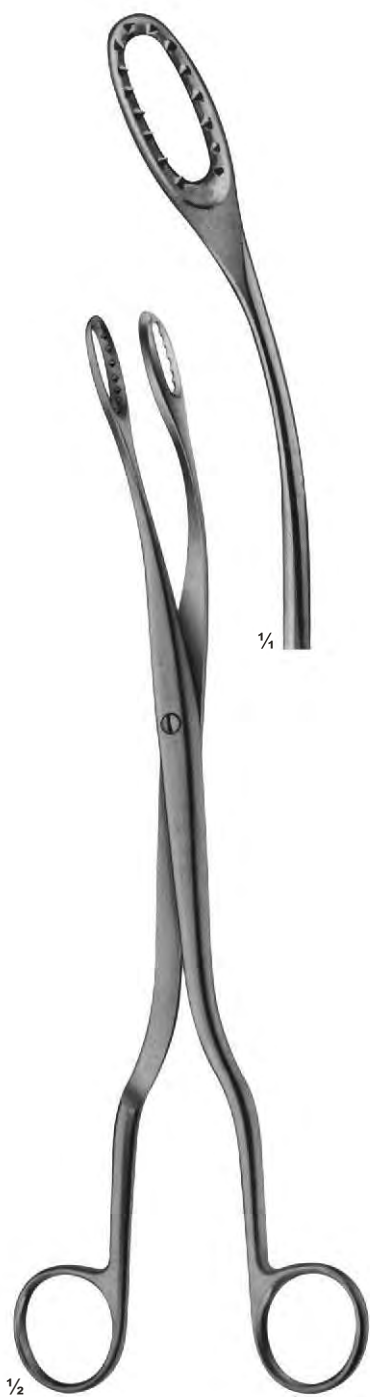

16-130
SAENGER
285 mm

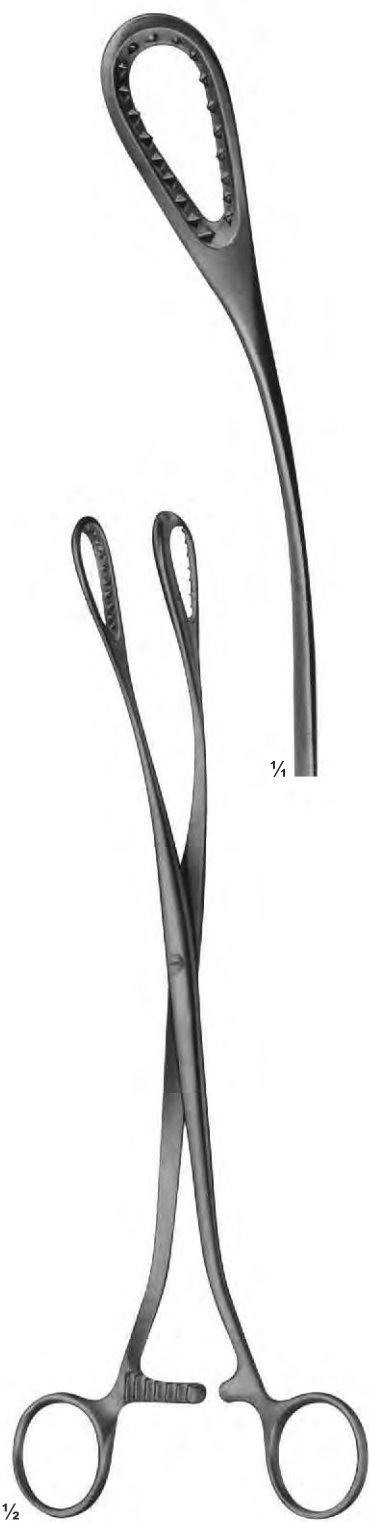

16-131
SAENGER
285 mm



16-132

16-133

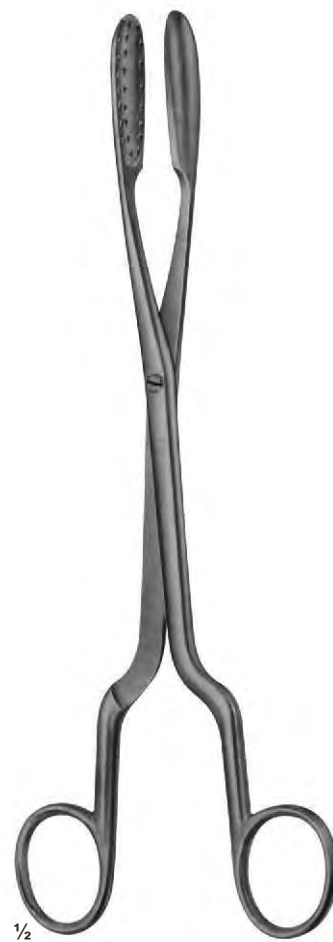

16-132 - 133
LEWKOWIZ
245 mm

Obstetrics-Placenta, Ovum and Cranioclast,
Basiotribe Forceps

REALSTAR SURGICAL
INSTRUMENTS

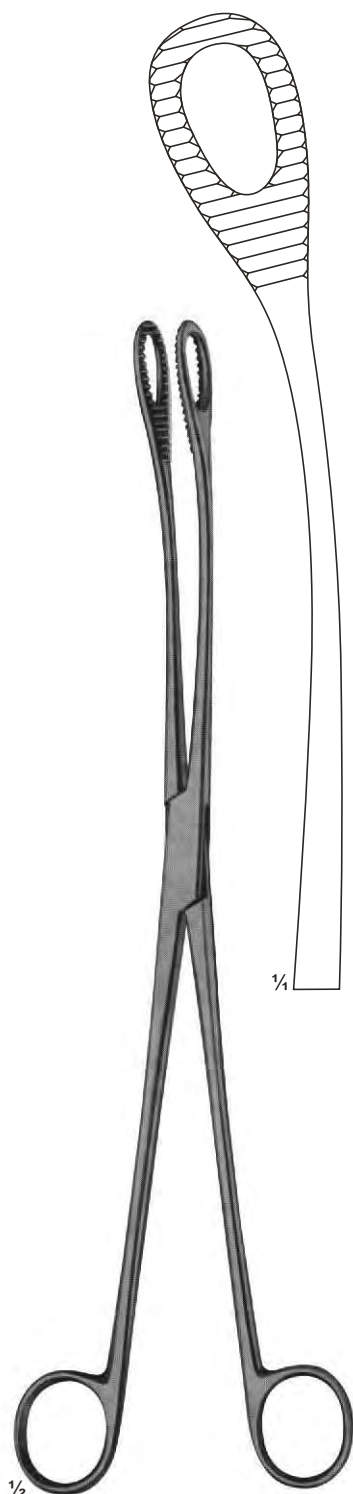

16-134
KELLY
320mm



16-135
SMELLIE
Perforator
270mm



16-136
BRAUN
Cranioclast
420mm

Tracheal Tubes with inner tubes

REALSTAR SURGICAL INSTRUMENTS



1/2

16-137
UECKERMANN-DENKER
Cryothyrotomy trocar
with silver cannula
130mm

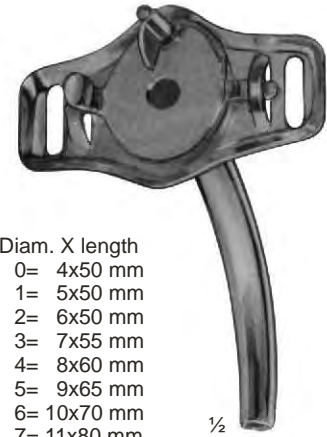

1/2

16-138 - 148
LUER
German silver

- Diam. X length
- 16-138** Fig. 0= 4x50 mm
 - 16-139** Fig. 1= 5x50 mm
 - 16-140** Fig. 2= 6x50 mm
 - 16-141** Fig. 3= 7x55 mm
 - 16-142** Fig. 4= 8x60 mm
 - 16-143** Fig. 5= 9x65 mm
 - 16-144** Fig. 6= 10x70 mm
 - 16-145** Fig. 7= 11x80 mm
 - 16-146** Fig. 8= 12x85 mm
 - 16-147** Fig. 9= 13x90 mm
 - 16-148** Fig. 10=14x90 mm



1/2

16-149 - 158
JACKSON
German Silver

- Diam. X length
- 16-149** Fig. 0= 4x50 mm
 - 16-150** Fig. 1= 5x58 mm
 - 16-151** Fig. 2= 6x58 mm
 - 16-152** Fig. 3= 7x70 mm
 - 16-153** Fig. 4= 8x78 mm
 - 16-154** Fig. 5= 9x84 mm
 - 16-155** Fig. 6= 10x84 mm
 - 16-156** Fig. 7= 11x86 mm
 - 16-157** Fig. 8= 12x88 mm
 - 16-158** Fig. 9= 13x90 mm



1/2

- Diam. X length
- 16-159** Fig. 1= 5x48 mm
 - 16-160** Fig. 2= 6x58 mm
 - 16-161** Fig. 3= 7x70 mm
 - 16-162** Fig. 4= 8x78 mm
 - 16-163** Fig. 5= 9x84 mm
 - 16-164** Fig. 6= 10x84 mm
 - 16-165** Fig. 7= 11x86 mm
 - 16-166** Fig. 8= 12x88 mm
 - 16-167** Fig. 9= 13x90 mm
 - 16-168** Fig.10= 14x90 mm

16-159 - 168
JACKSON
German Silver

Tound-and Tracheal Hooks and Dilators

REALSTAR SURGICAL INSTRUMENTS



16-169
BOSE
165 mm



16-170
BOSE
165 mm



16-171 - 173
180 mm

16-171
sharp



16-172
blunt

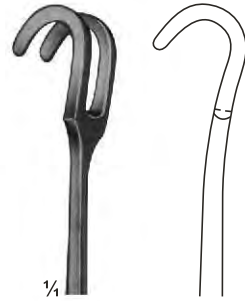

16-173
stumpf/blunt



16-174
FINSEN
50 mm



16-175
FINSEN
70 mm



16-176
TROUSSEAU
120 mm



16-177
LABORDE
125 mm



16-178
LABORDE
strong pattern
135 mm



16-179
Cleaning Brush
for tracheal tubes
285 mm

Irrigating Cannulae, Embolus Grasping Forceps, Dilators

REALSTAR SURGICAL INSTRUMENTS

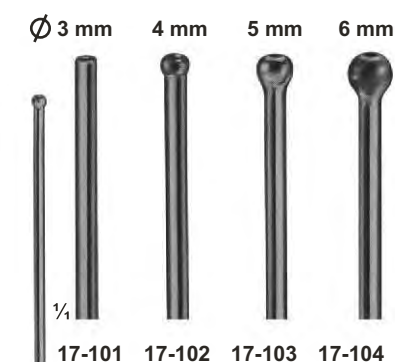

17-101 - 104
SCHMID
 Vessel irrigating cannulae,
 malleable, silver plated
 150 mm



17-105
BLAKE
 Embolus grasping
 forceps
 205 mm

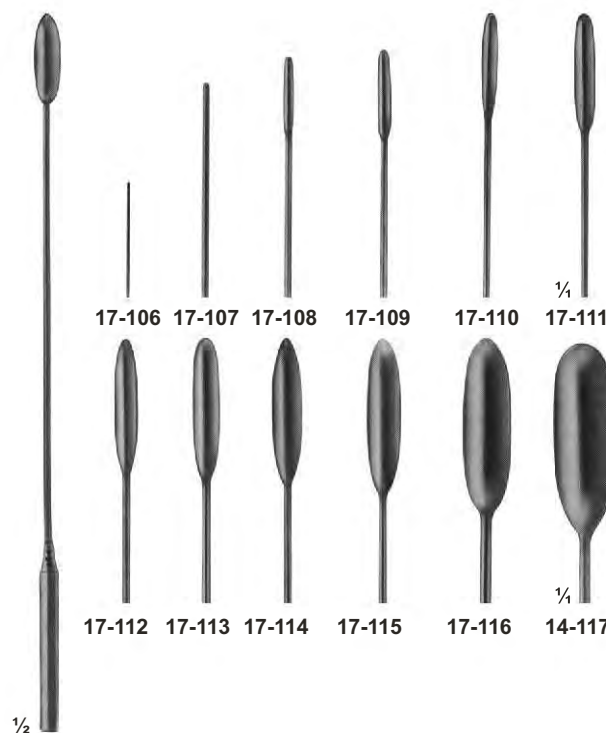

17-106 - 117
DE BAKEY
 Vascular dilators,
 malleable
 190 mm

17-106	0,5 mm Ø	17-112	3,5 mm Ø
17-107	1,0 mm Ø	17-113	4,0 mm Ø
17-108	1,5 mm Ø	17-114	4,5 mm Ø
17-109	2,0 mm Ø	17-115	5,0 mm Ø
17-110	2,5 mm Ø	17-116	7,0 mm Ø
17-111	3,0 mm Ø	17-117	9,0 mm Ø

Irrigating Cannulae, Embolus Grasping Forceps, Dilators

REALSTAR SURGICAL INSTRUMENTS

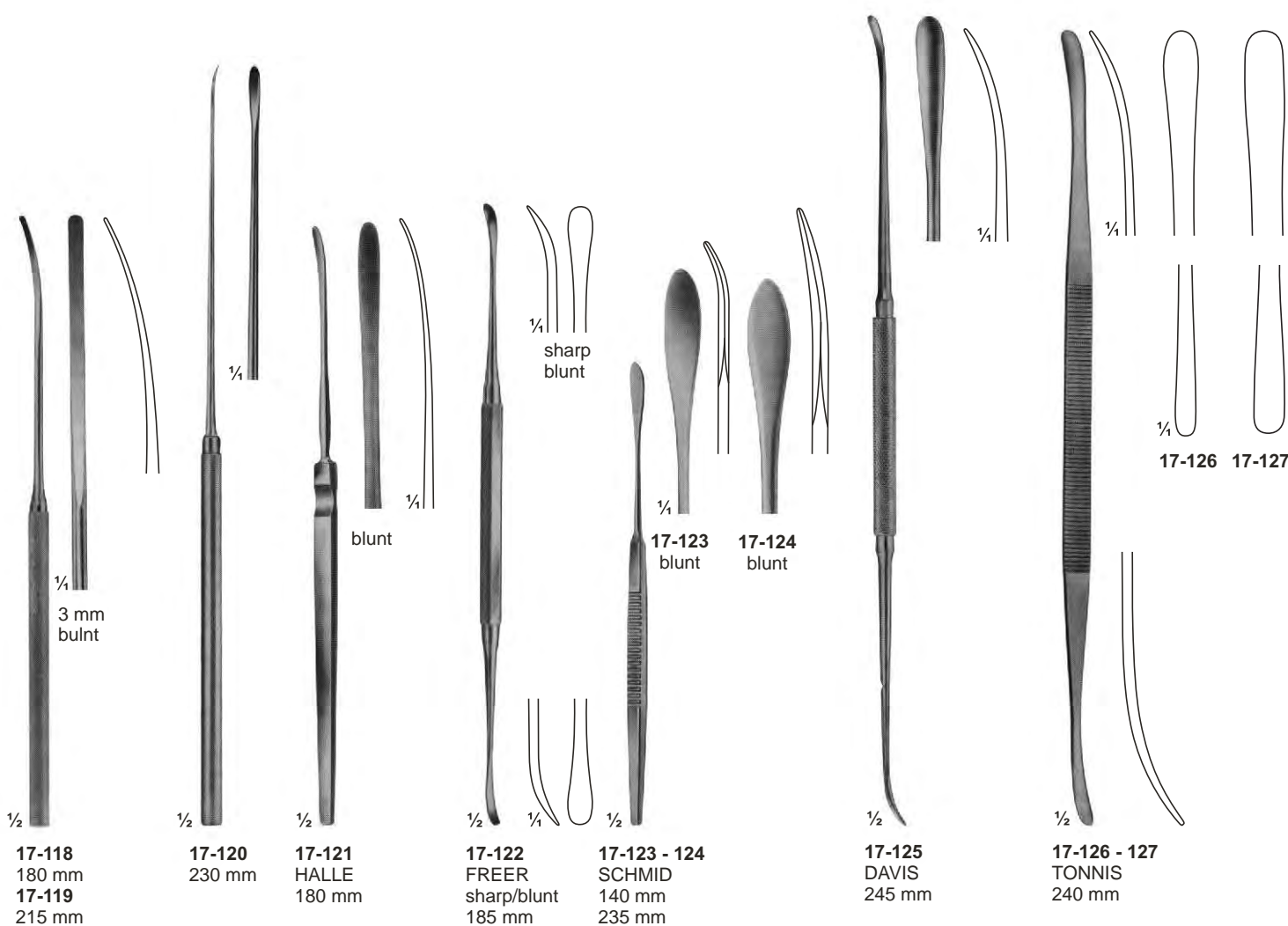

Irrigating Cannulae, Embolus Grasping Forceps, Dilators

REALSTAR SURGICAL INSTRUMENTS

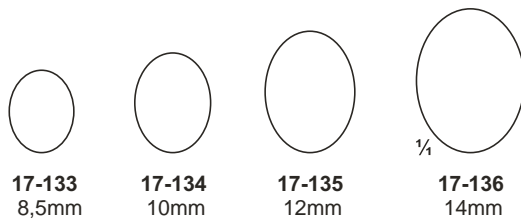
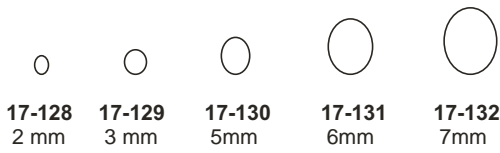

17-128 - 136
Endarterectomy strippers
550 mm



17-137
Handle for
110 mm



17-138 - 139
RUMEL-BELBONT
325 mm
17-138 - 4,0 mm Ø
17-139 - 6,4 mm Ø

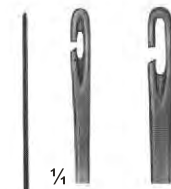

17-140 17-141



17-140 - 141
Guide only

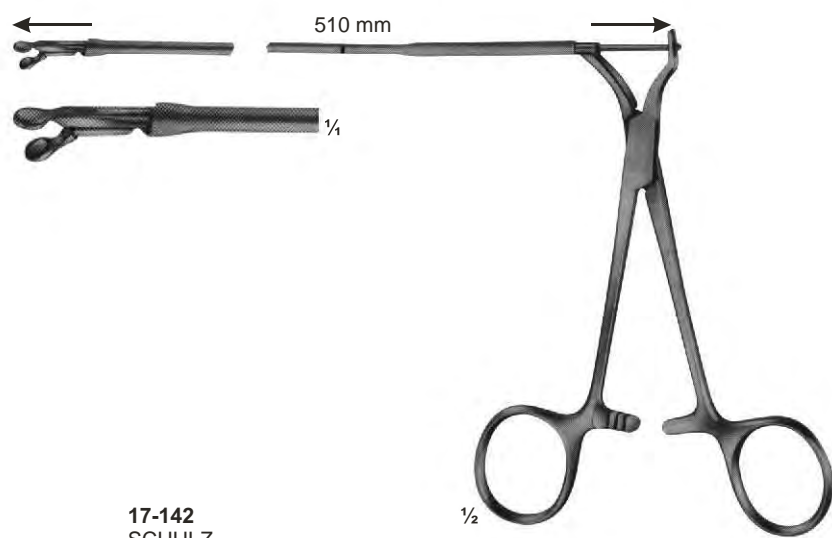

17-142 SCHULZ
Biopotome, mit flexiblem Schaft, 510 mm lang, with round jaws 3 mm diam.

Biopsy forceps, for biopsy from the right atrium through cava juglaris, prior to heart implantations.

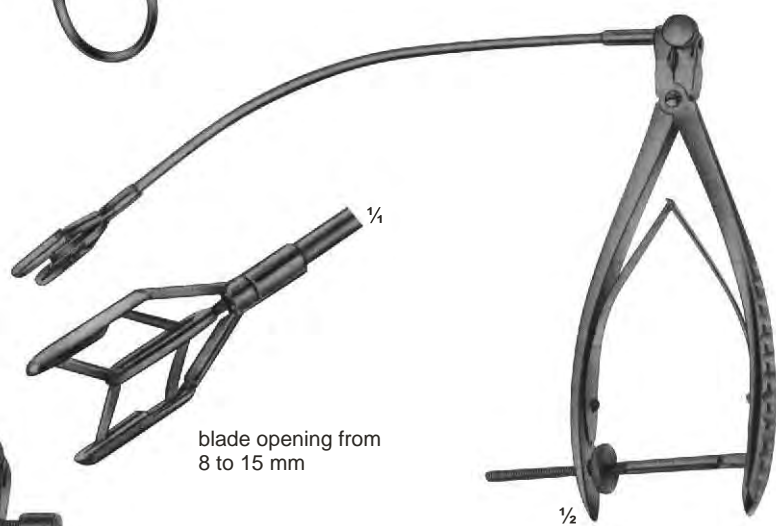

17-144 COOLEY
Dilator for mitral valve for children

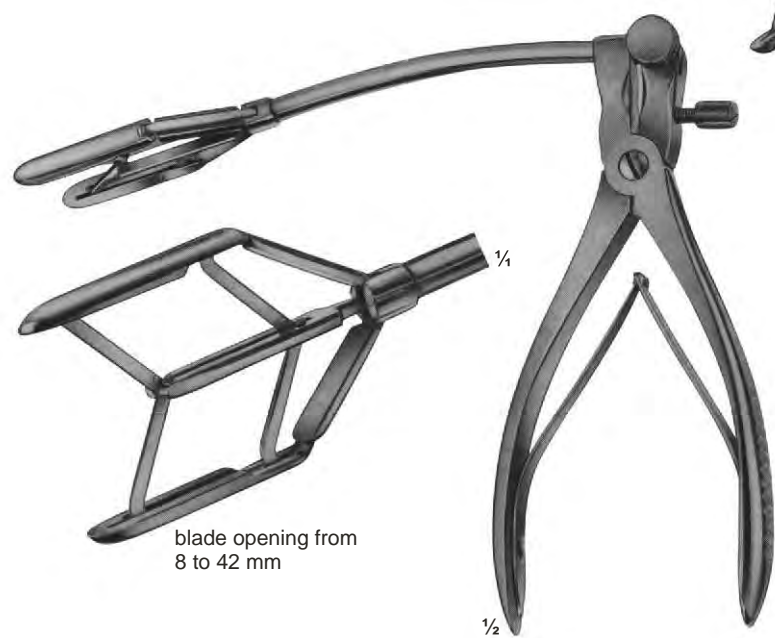

17-143 TUBBS
Dilator for mitral valve

Biopotome and Aortic Dilators

REALSTAR SURGICAL INSTRUMENTS

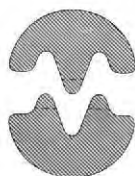
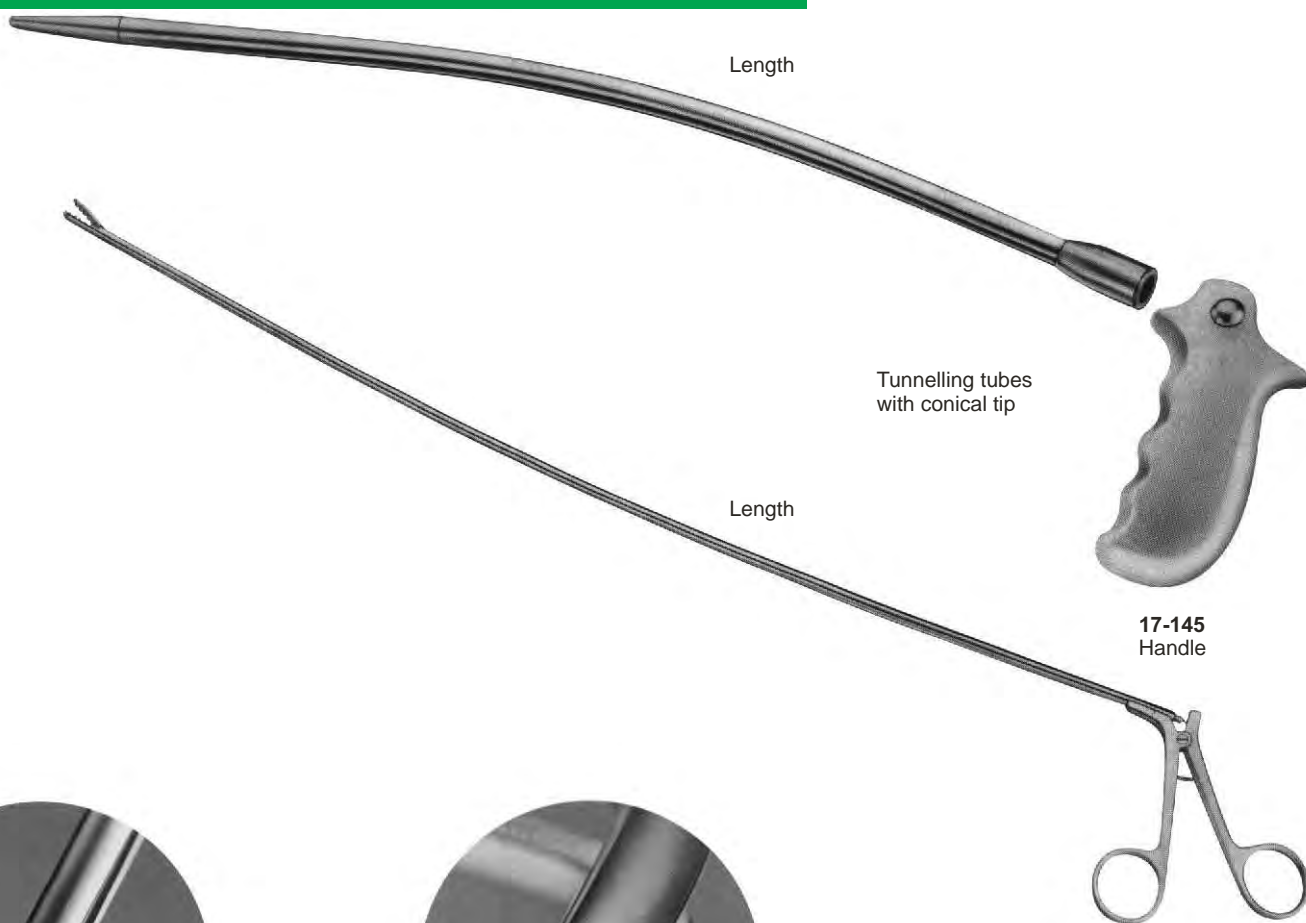

DE BAKEY
17-147
1 : 2 rows of teeth

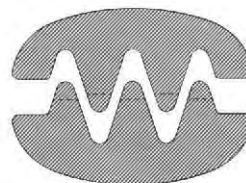

DE BAKEY
17-148
2 : 3 rows of teeth

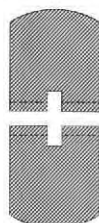

COOLEY
17-149
2 : 2 rows of teeth



DARDIK
17-150
2 : 3 rows of teeth

Ultra-Light-Forceps

REALSTAR SURGICAL INSTRUMENTS



17-151
Width of jaws
1,5 mm
Length
150mm

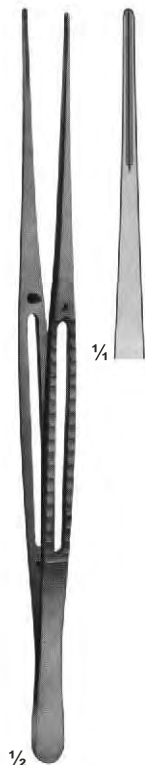

17-152
1,5 mm
200 mm



17-153
1,5 mm
240 mm



17-154
1,5 mm
300 mm

Ultra-Light-Forceps

REALSTAR SURGICAL INSTRUMENTS

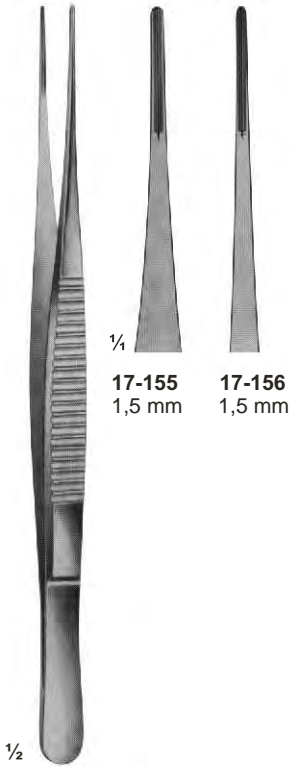

17-155
1,5 mm

17-156
1,5 mm

$\frac{1}{2}$

17-155 - 156
DE BAKEY
150 mm
300 mm

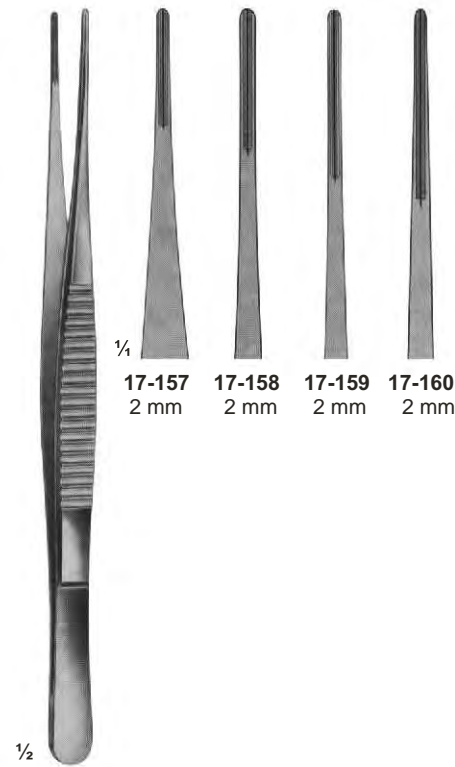

$\frac{1}{4}$

17-157 2 mm

17-158 2 mm

17-159 2 mm

17-160 2 mm

$\frac{1}{2}$

17-157 - 160
DE BAKEY
150 mm 200 mm
300 mm 240 mm

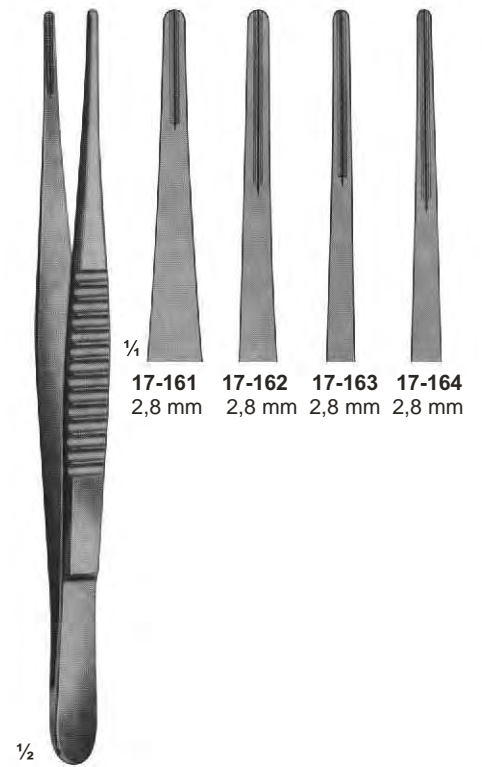

$\frac{1}{4}$

17-161 2,8 mm

17-162 2,8 mm

17-163 2,8 mm

17-164 2,8 mm

$\frac{1}{2}$

17-161 - 164
DE BAKEY
150 mm 200 mm
300 mm 240 mm

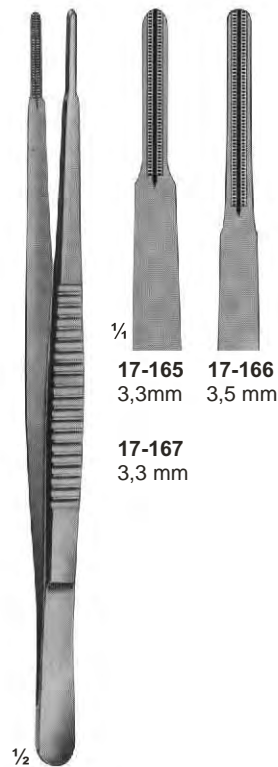

$\frac{1}{4}$

17-165 3,3mm

17-166 3,5 mm

17-167
3,3 mm

$\frac{1}{2}$

17-165 - 167
DE BAKEY
200 mm
300 mm 240 mm

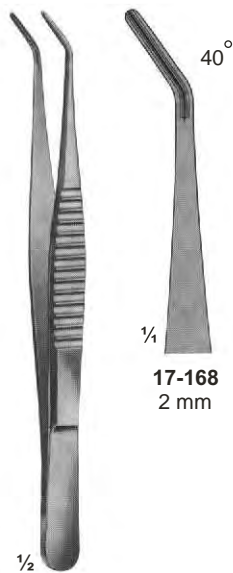

$\frac{1}{4}$

17-168
2 mm

$\frac{1}{2}$

17-168
DE BAKEY
150 mm

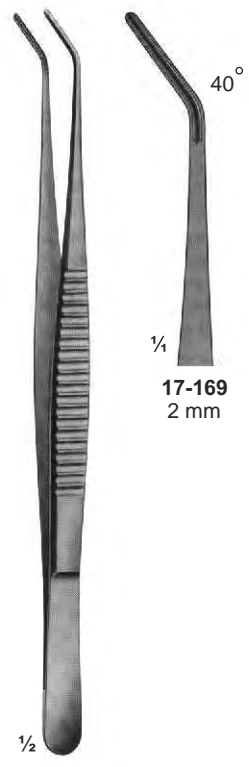

$\frac{1}{4}$

17-169
2 mm

$\frac{1}{2}$

17-169
DE BAKEY
200 mm

Ring Handle Bulldog Clamps

REALSTAR SURGICAL INSTRUMENTS

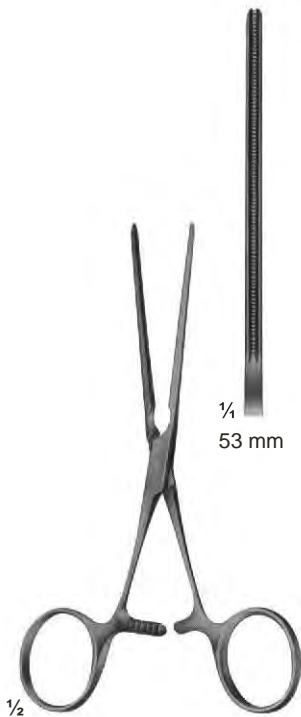

17-170
DE-BAKEY
gerade straight
130 mm

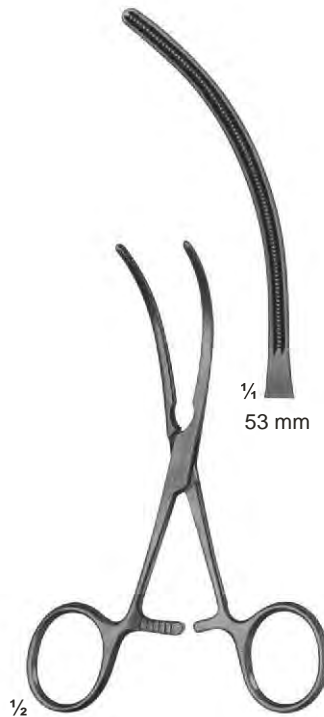

17-171
DE-BAKEY
Maul gebogen
curved jaws
125 mm

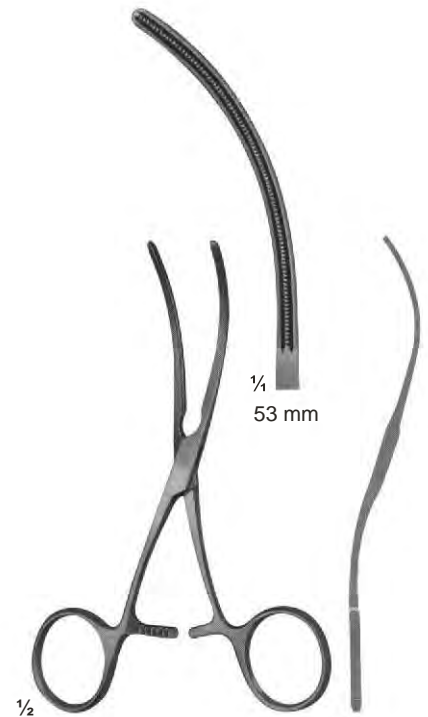

17-172
DE-BAKEY
S-shaped curved
125 mm

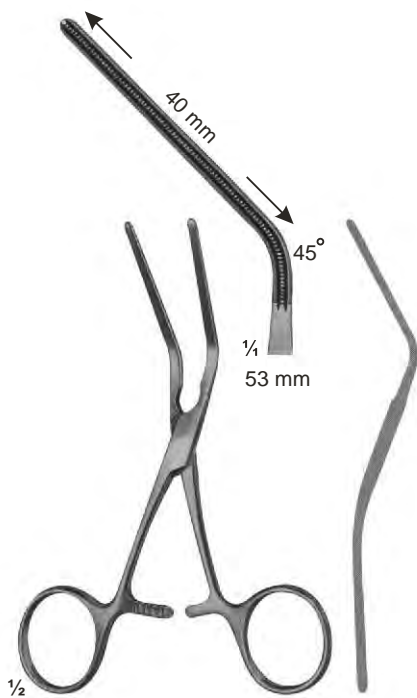

17-173
DE-BAKEY
45° winklig gebogen
angled 45°
125 mm



17-174
DE-BAKEY
90° winklig gebogen
angled 90°
105 mm

REALSTAR SURGICAL INSTRUMENTS

graduated



1/2

17-175 - 178
CASTANESA

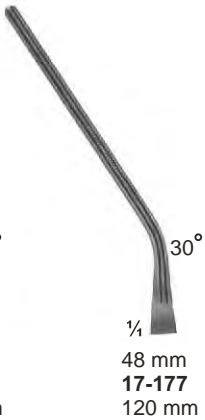
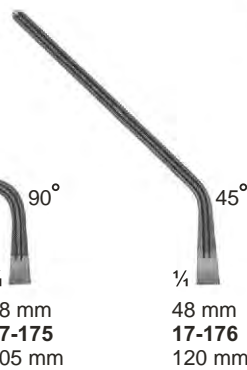

graduated



1/2

17-179 - 182
CASTANESA

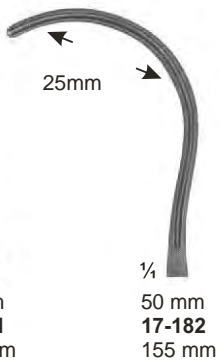
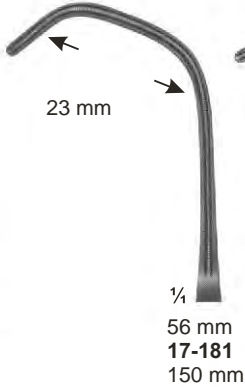
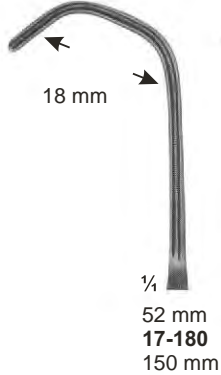
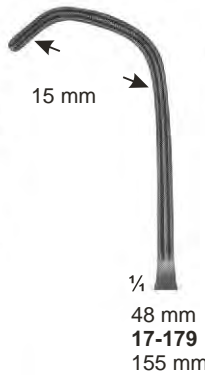

Anastomosis-and Multi-Purpose-Clamps-Pediatric types

REALSTAR SURGICAL INSTRUMENTS

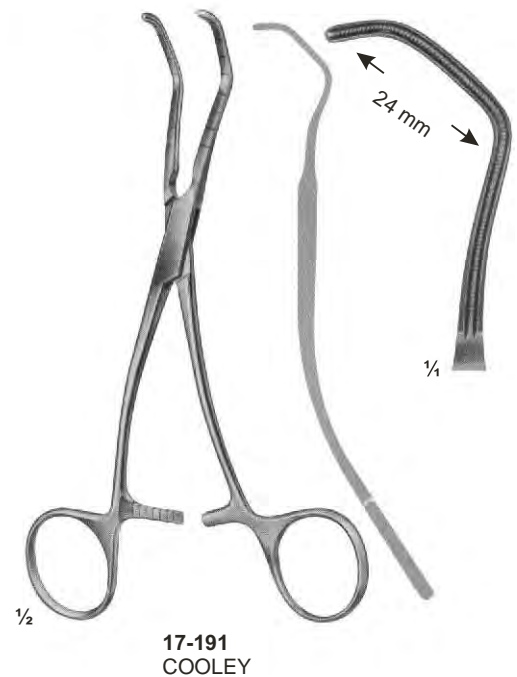
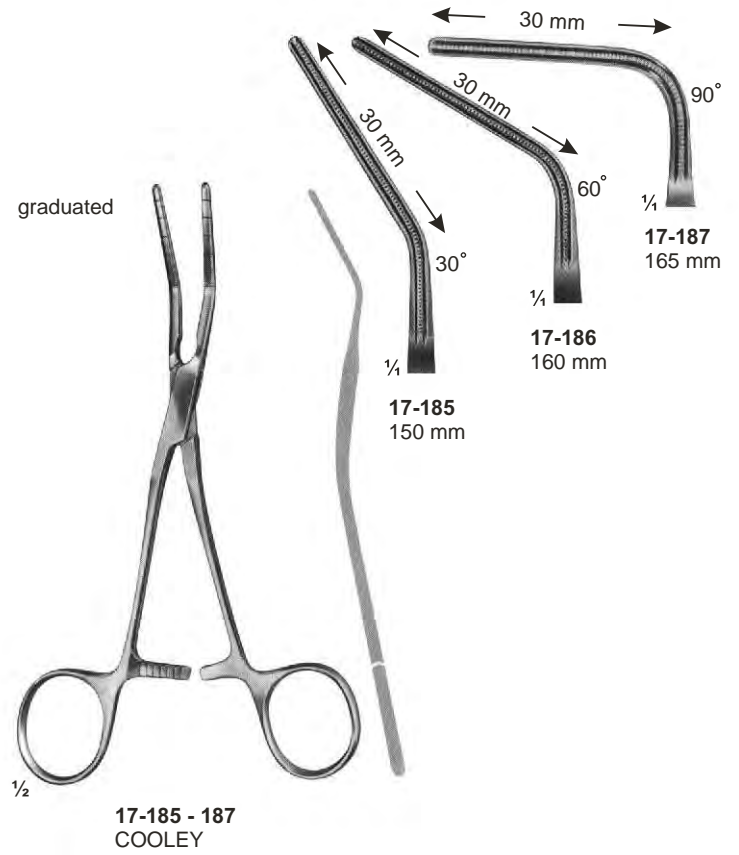
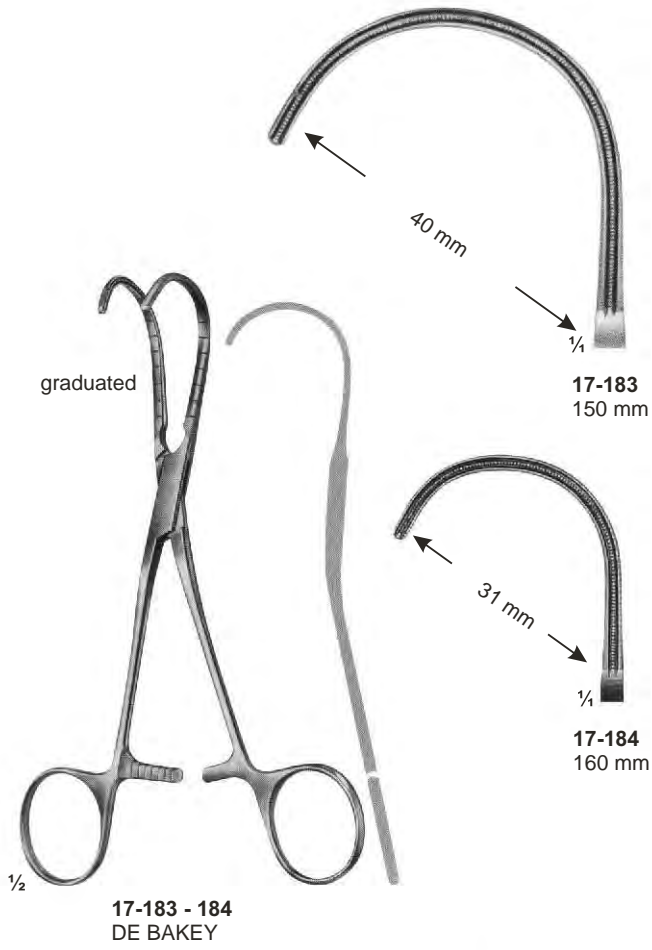

Non-traumatic Haemostatic Forceps

REALSTAR SURGICAL INSTRUMENTS

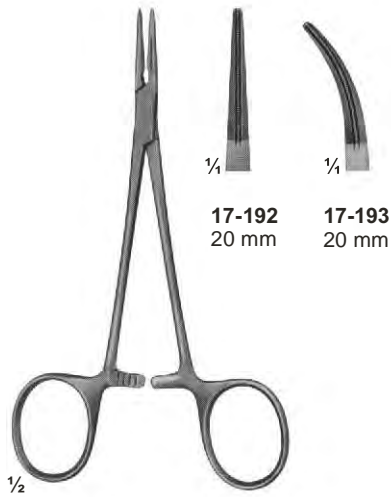

17-192
20 mm

17-193
20 mm

17-192 - 193
125 mm



17-194
27 mm

17-195
27 mm

17-194 - 195
165 mm



17-196
40 mm

17-197
40 mm

17-196 - 197
DE BAKEY-BAINRIDGE
155 mm

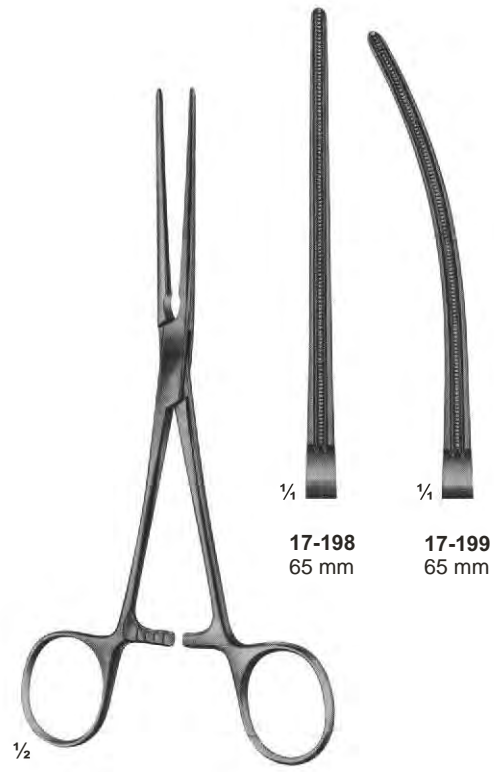

17-198
65 mm

17-199
65 mm

17-198 - 199
DE BAKEY-BAINRIDGE
180 mm

Non-traumatic Haemostatic Forceps

REALSTAR SURGICAL INSTRUMENTS



17-200 - 201
DE-BAKEY-KELLY
140 mm



17-202 - 203
PEAN
155 mm

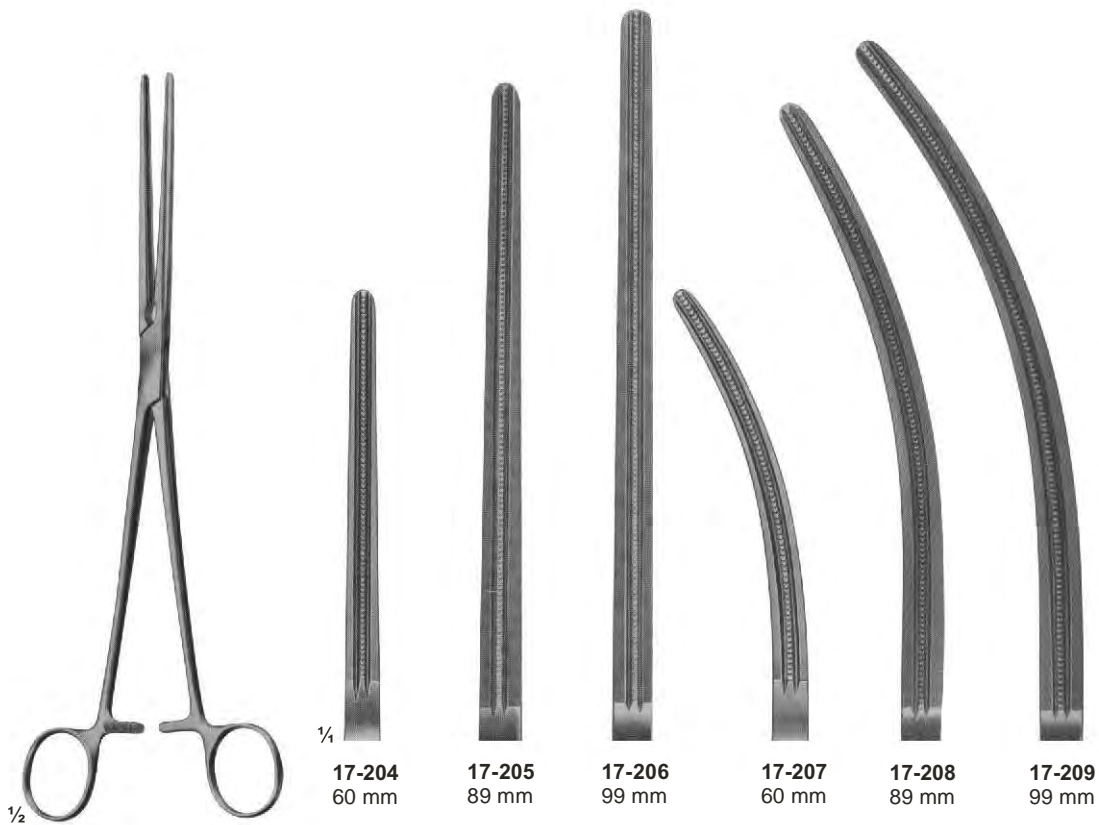

17-204 - 209
DE-BAKEY-PEAN DE-BAKEY-PEAN
17-204 200 mm **17-207** 200 mm
17-205 265 mm **17-208** 260 mm
17-206 280 mm **17-209** 275 mm

Anastomosis Clamps

REALSTAR SURGICAL INSTRUMENTS

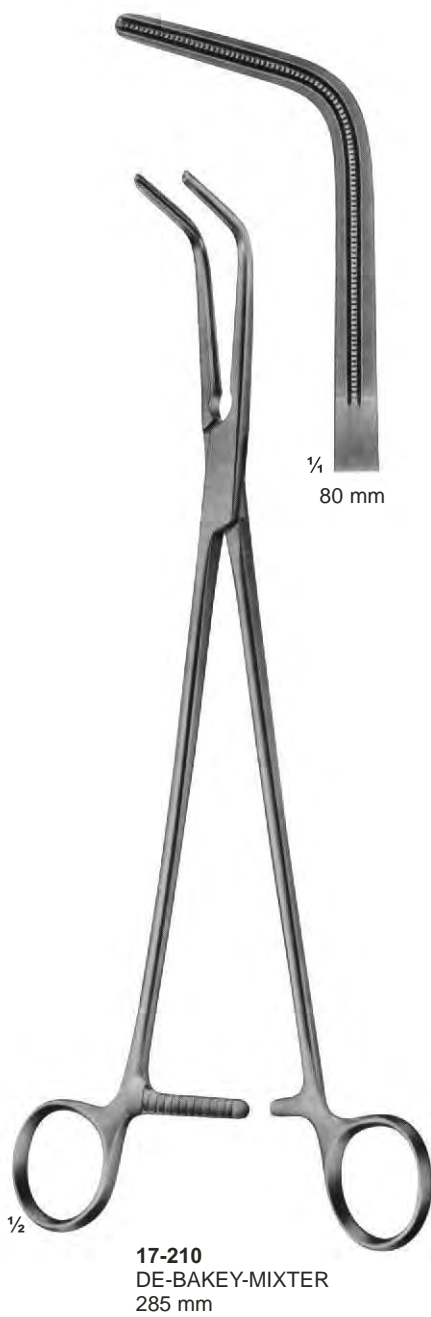

Vena-Cava Clamps

REALSTAR SURGICAL INSTRUMENTS

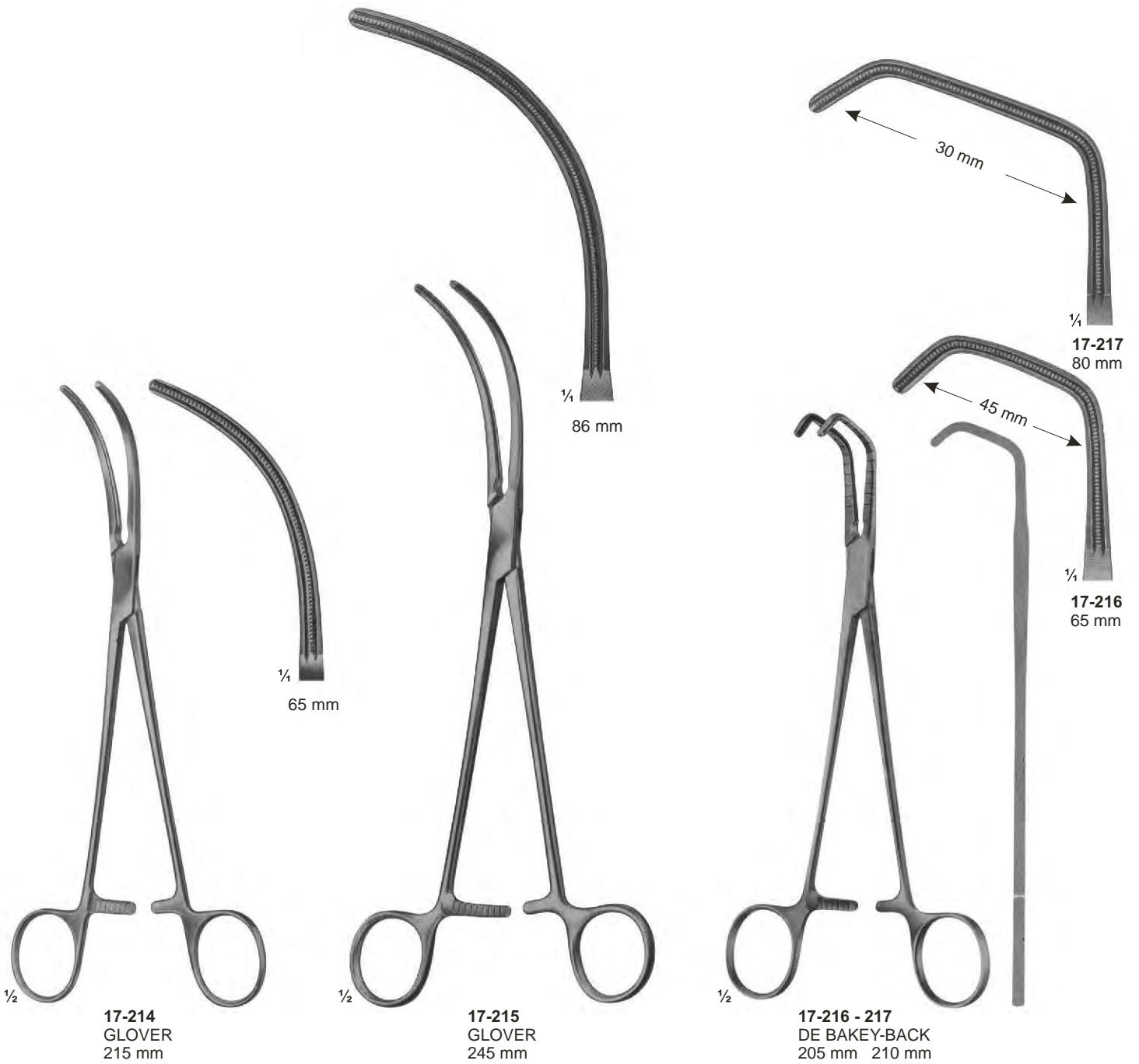

Vena-Cava Clamps

REALSTAR SURGICAL INSTRUMENTS



1/2

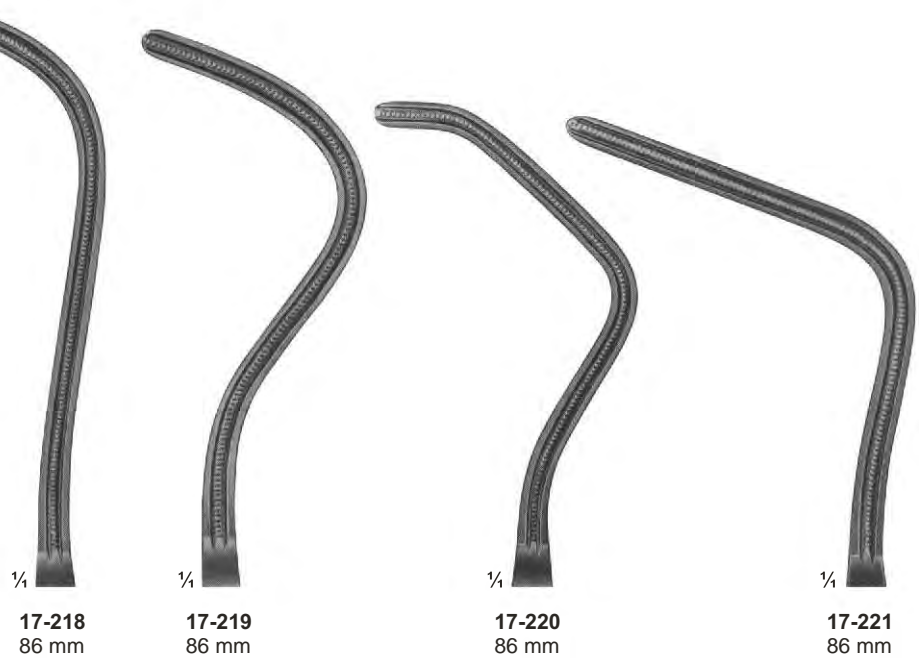

1/4 17-218 86 mm 1/4 17-219 86 mm 1/4 17-220 86 mm 1/4 17-221 86 mm

17-218 - 221
DE BAKEY-HARKEN
17-218 - 255 mm
17-219 - 245 mm
17-220 - 245 mm
17-221 - 245 mm



1/2

17-222 - 226
DE BAKEY

Total Length: 220 mm
Length of jaws: 85 mm

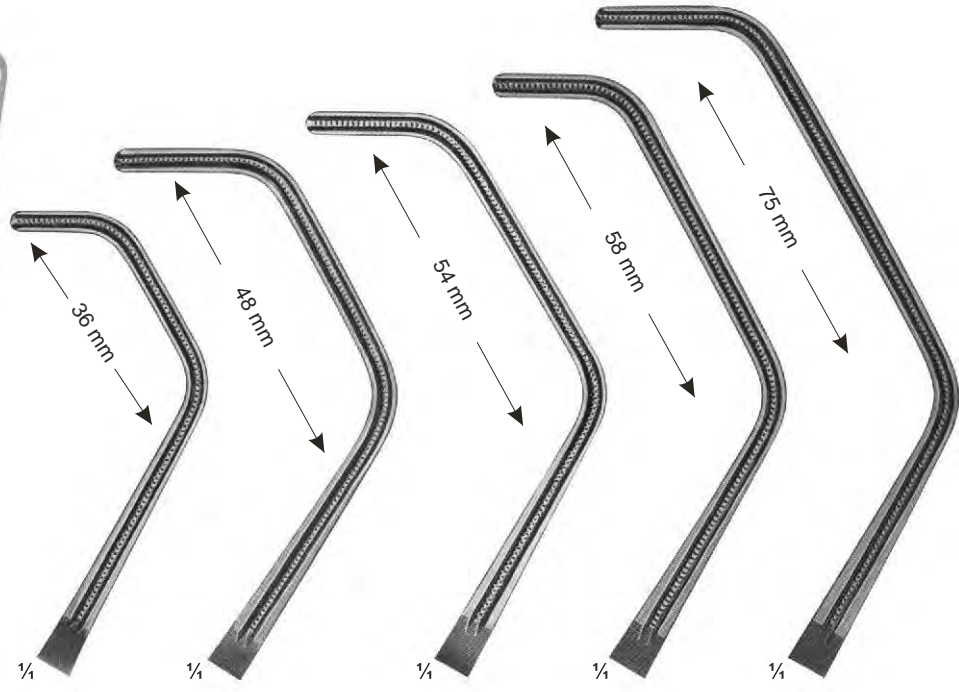

1/4 17-222 36 mm 1/4 17-223 48 mm 1/4 17-224 54 mm 1/4 17-225 58 mm 1/4 17-226 75 mm

1/4 17-222 220 mm 1/4 17-223 256 mm 1/4 17-224 270 mm 1/4 17-225 270 mm 1/4 17-226 280 mm

1/4 17-222 85 mm 1/4 17-223 95 mm 1/4 17-224 99 mm 1/4 17-225 103 mm 1/4 17-226 119 mm

Vena-Cava Clamps

REALSTAR SURGICAL INSTRUMENTS



1/2
17-227 - 229
 DE BAKEY-SATINSKY
 235 mm, 240 mm, 245 mm

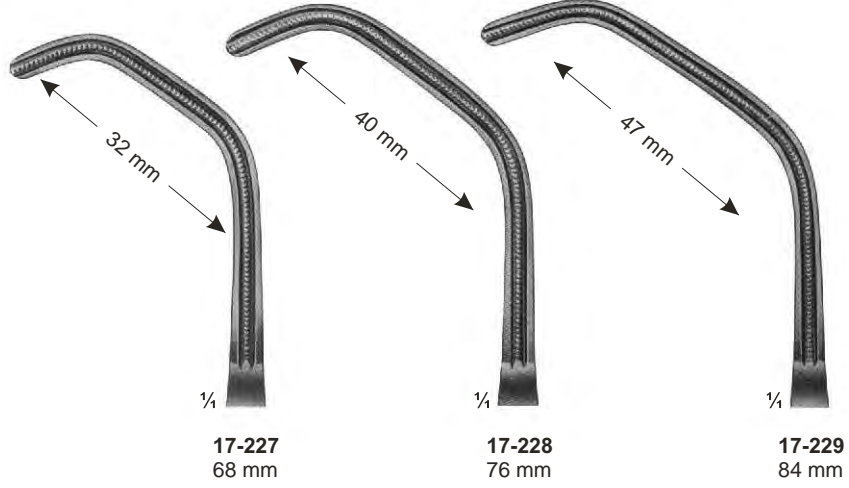

1/4
17-227
 68 mm

1/4
17-228
 76 mm

1/4
17-229
 84 mm



1/2
17-230 - 231
 DE BAKEY
 170 mm, 165 mm



1/4
17-230
 50 mm

1/4
17-231
 50 mm



1/2
17-232
 DE BAKEY
 165 mm

1/4
 50 mm

Vena-Cava Clamps

REALSTAR SURGICAL INSTRUMENTS

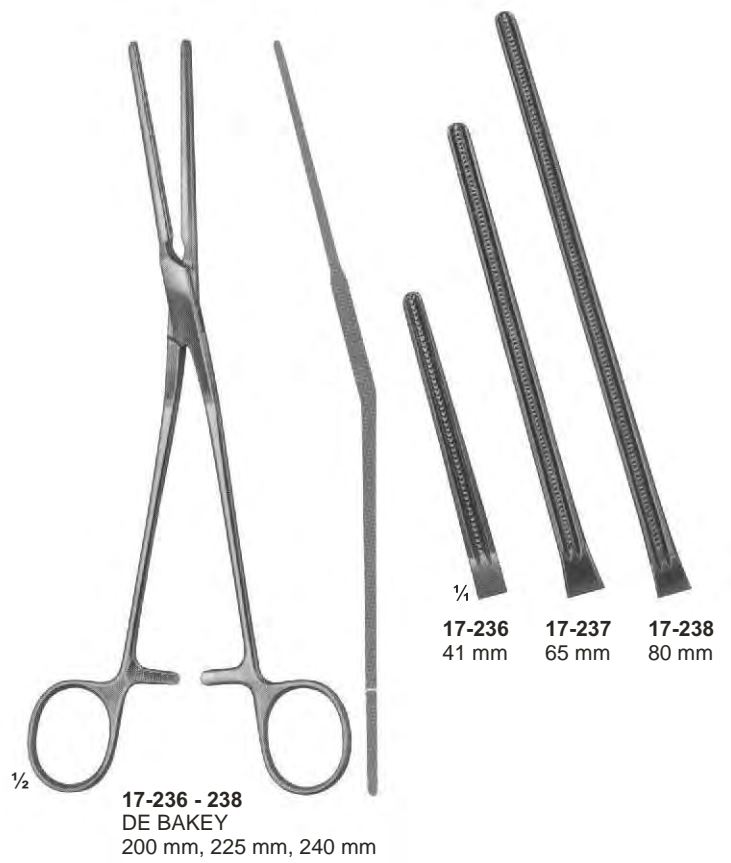
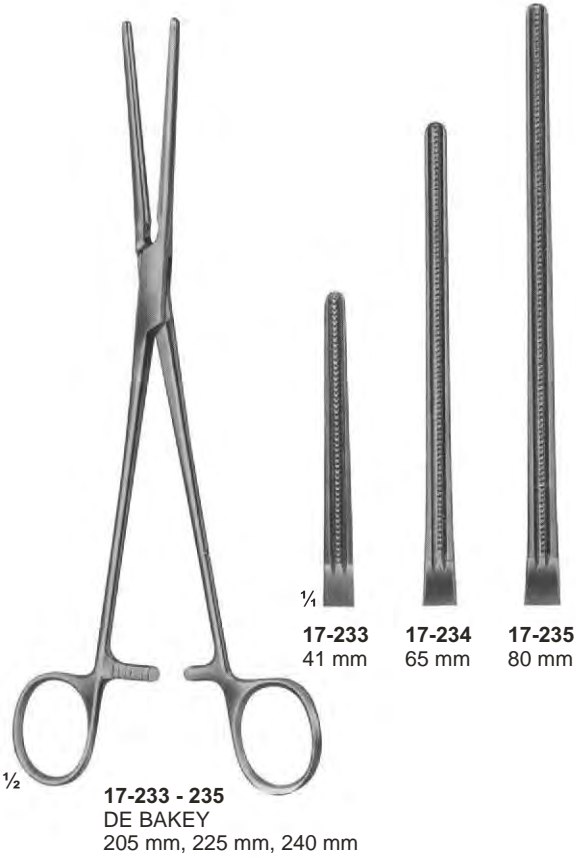

Vena-Cava Clamps

REALSTAR SURGICAL INSTRUMENTS

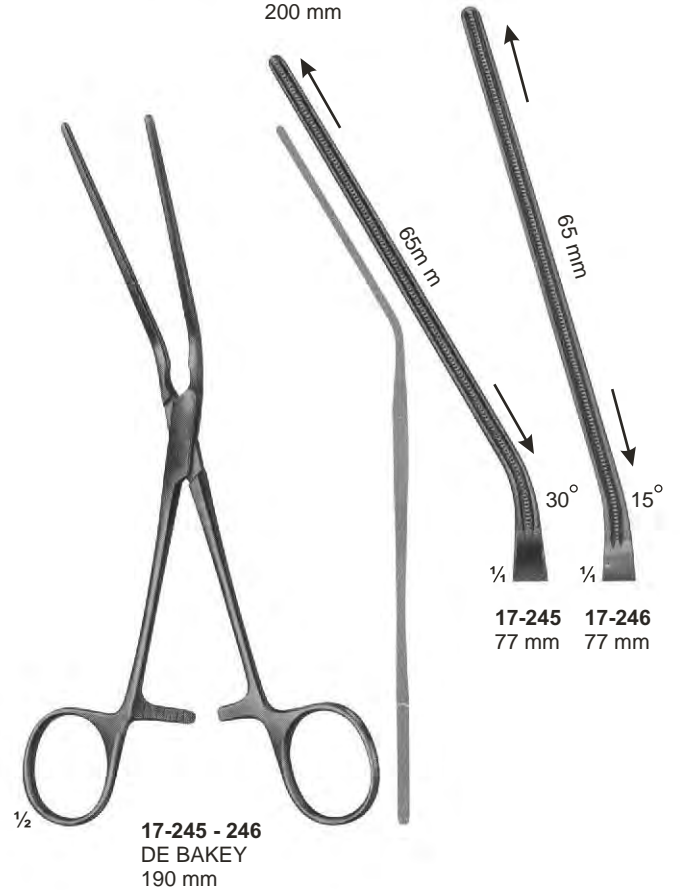
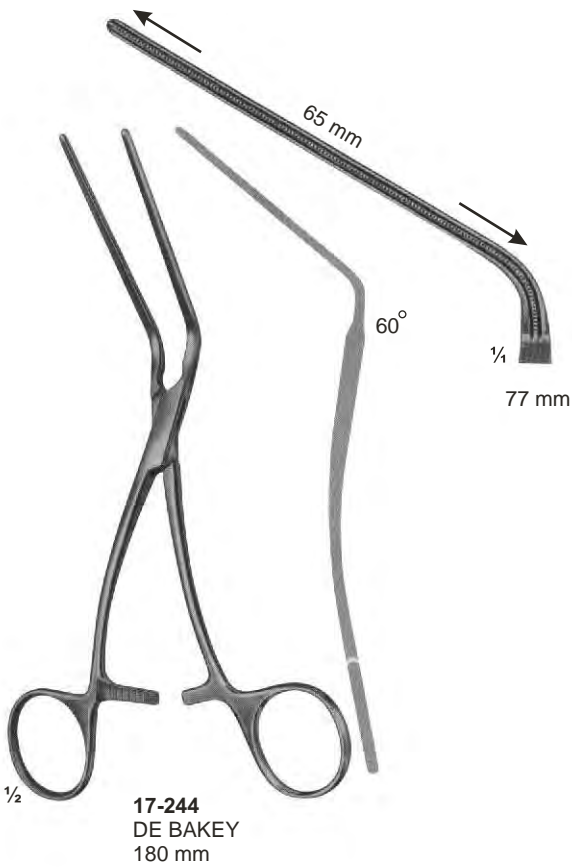
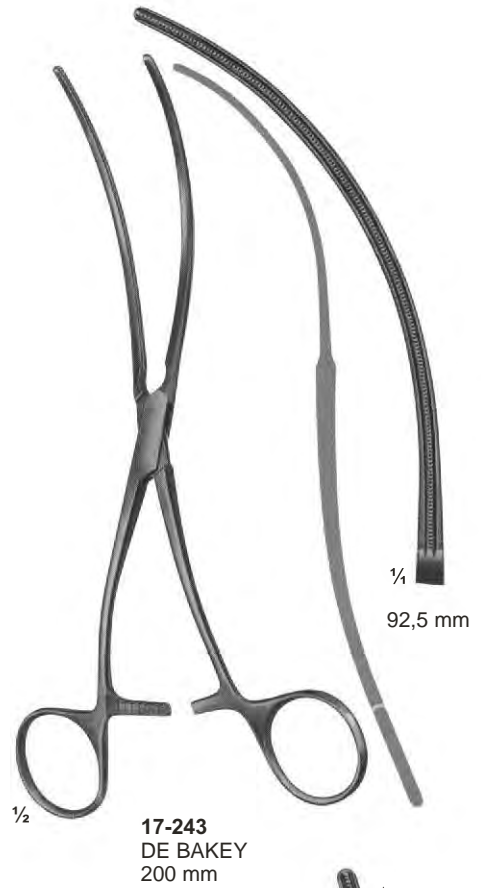

Vena-Cava Clamps

REALSTAR SURGICAL INSTRUMENTS



17-247
LELAND-JONES
195 mm



17-248
DE BAKEY
200 mm

Iliac clamp



17-249
WERTHEIM
250 mm

Vena-Cava Clamps

REALSTAR SURGICAL INSTRUMENTS

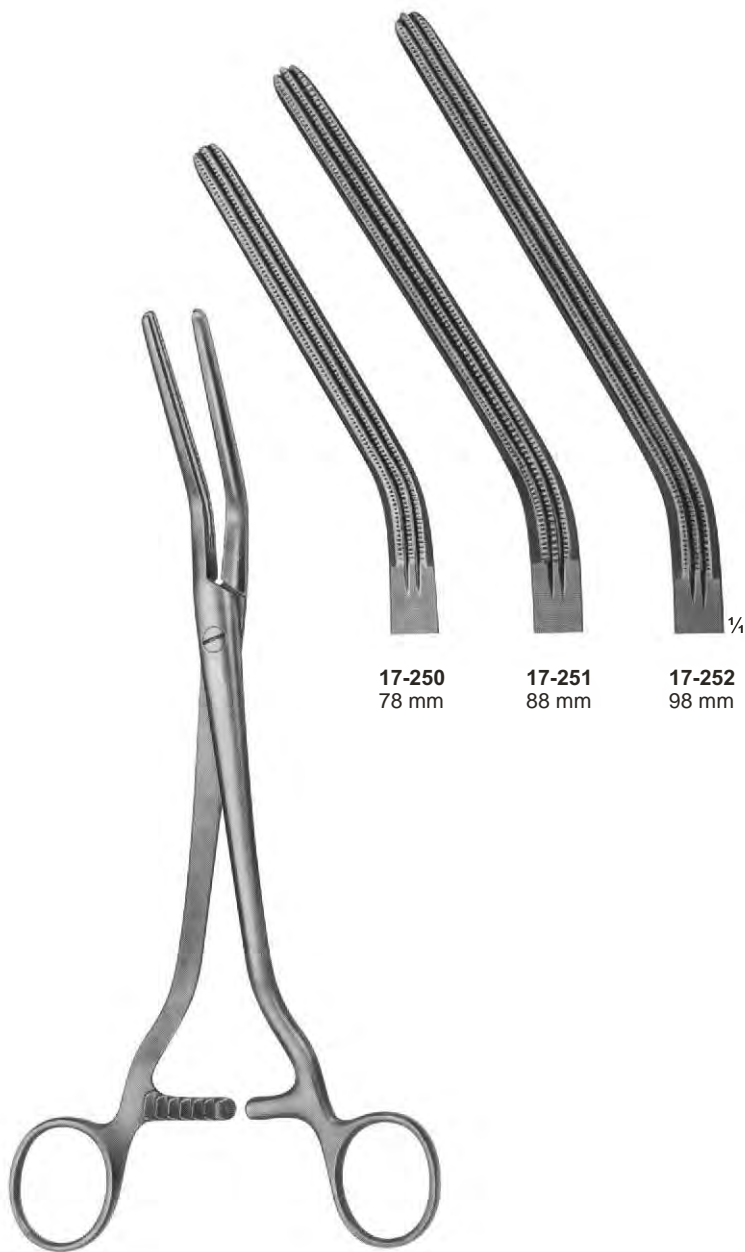

17-250
78 mm

17-251
88 mm

17-252
98 mm

17-250 - 252
DICK
255 mm, 265 mm, 275 mm

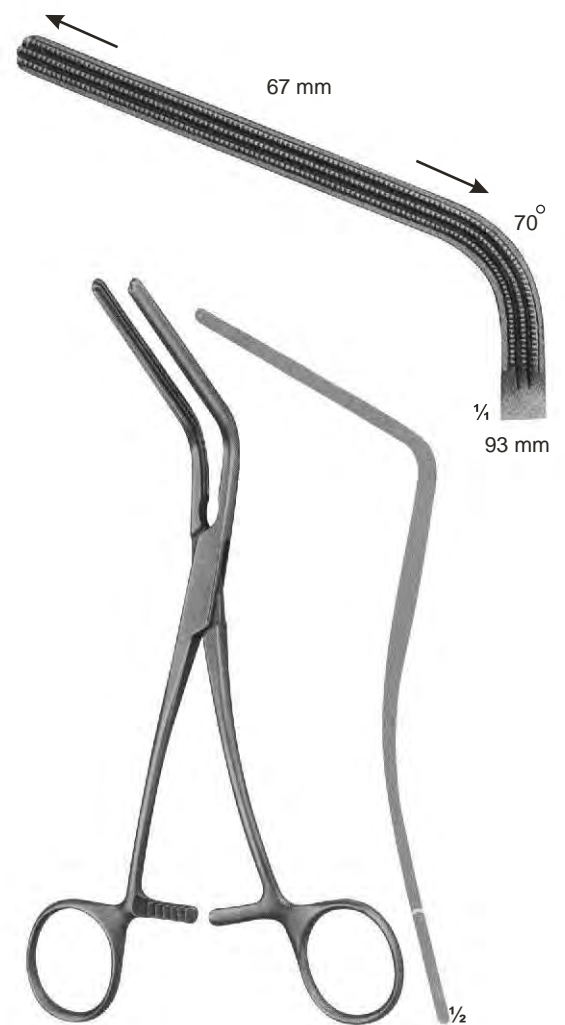

17-253
MORRIS
175 mm

Vena-Cava Clamps

REALSTAR SURGICAL INSTRUMENTS

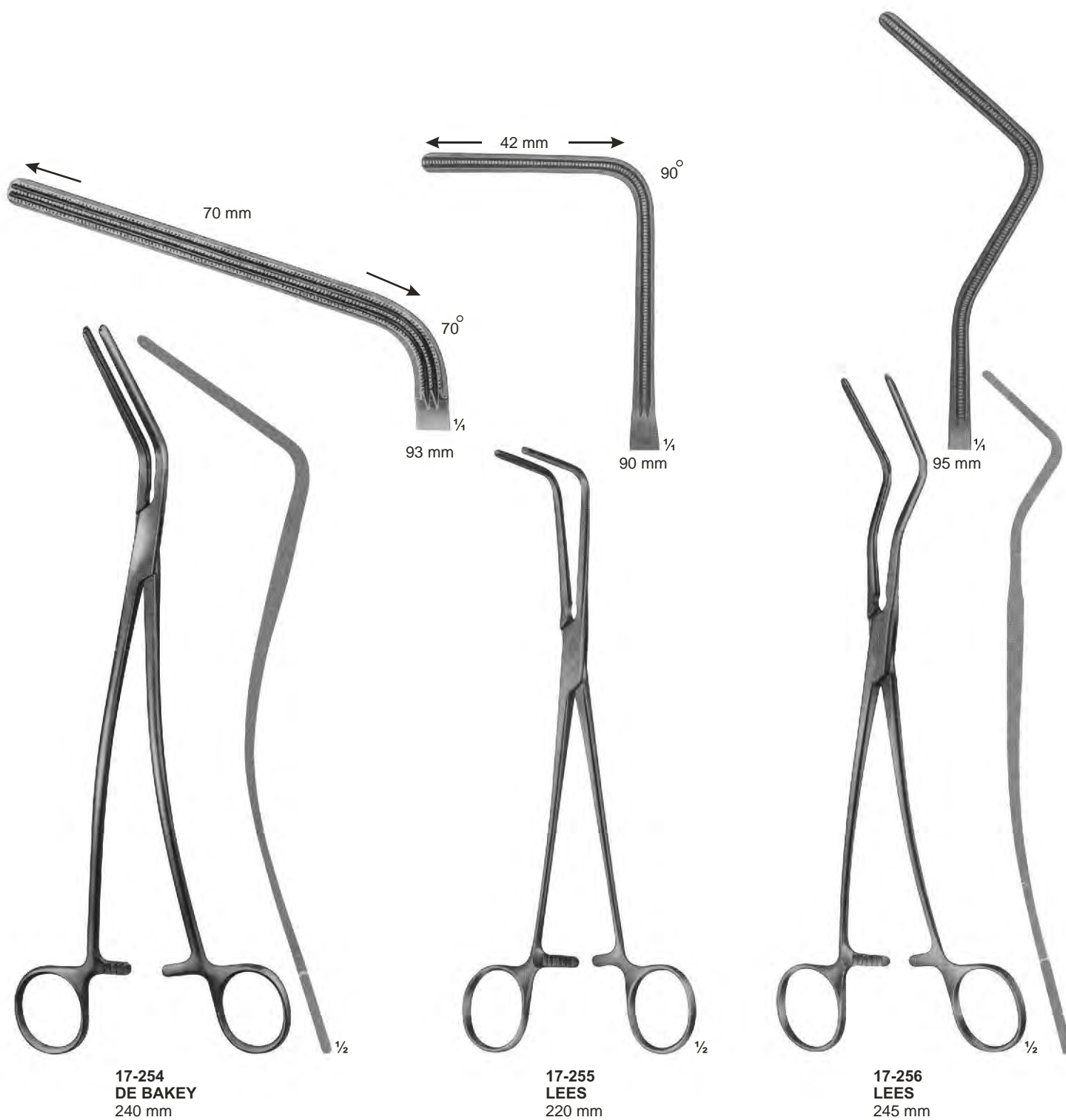

Vena-Cava Clamps

REALSTAR SURGICAL INSTRUMENTS

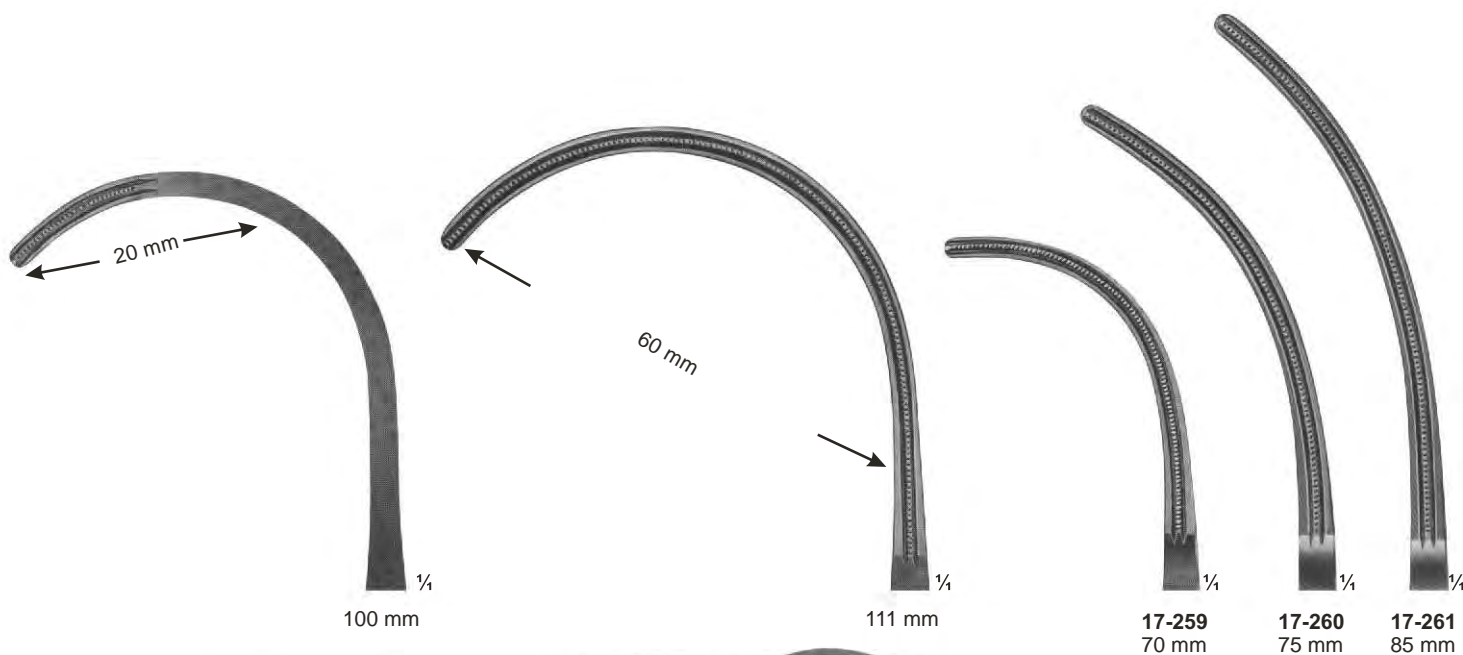

**17-257
DE BAKEY**
265 mm



**17-258
DE BAKEY**
270 mm



**17-259 - 261
DE BAKEY**
255 mm, 265 mm, 280 mm

Vena-Cava Clamps

REALSTAR SURGICAL INSTRUMENTS



17-262 95 mm
17-263 110 mm
17-264 130 mm
17-265 140 mm

17-262 - 265
DE BAKEY
250 mm, 300 mm,
315 mm, 330 mm



115 mm

17-266
DE BAKEY
300 mm

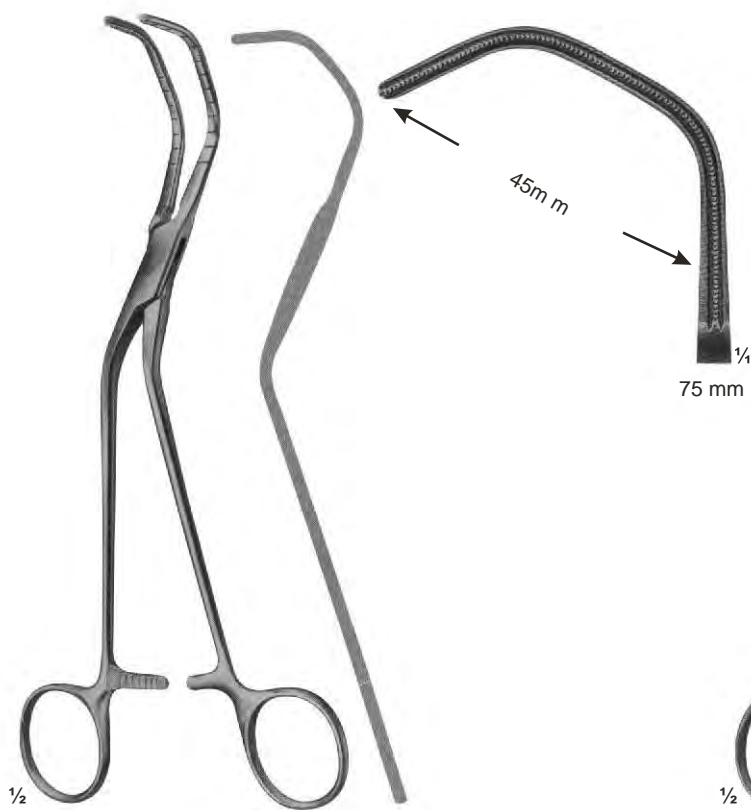

**17-267
DIETRICH**
210 mm

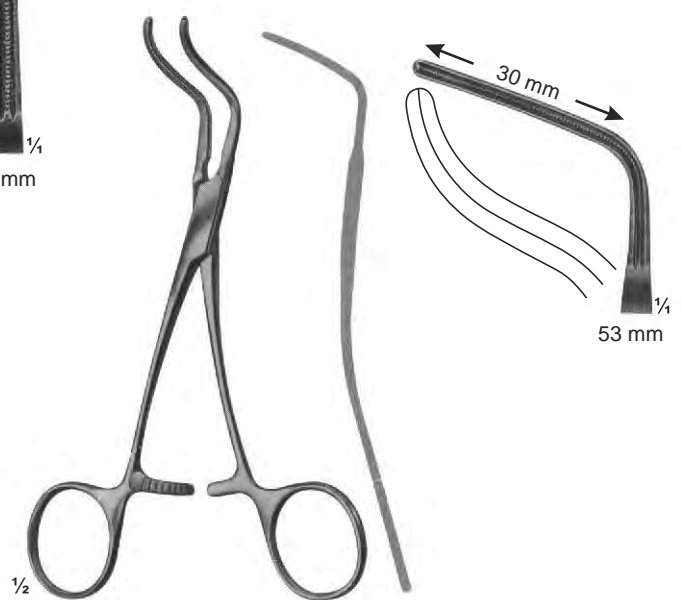

**17-268
SUBRAMANIAN**
155 mm

Vena-Cava Clamps

REALSTAR SURGICAL INSTRUMENTS

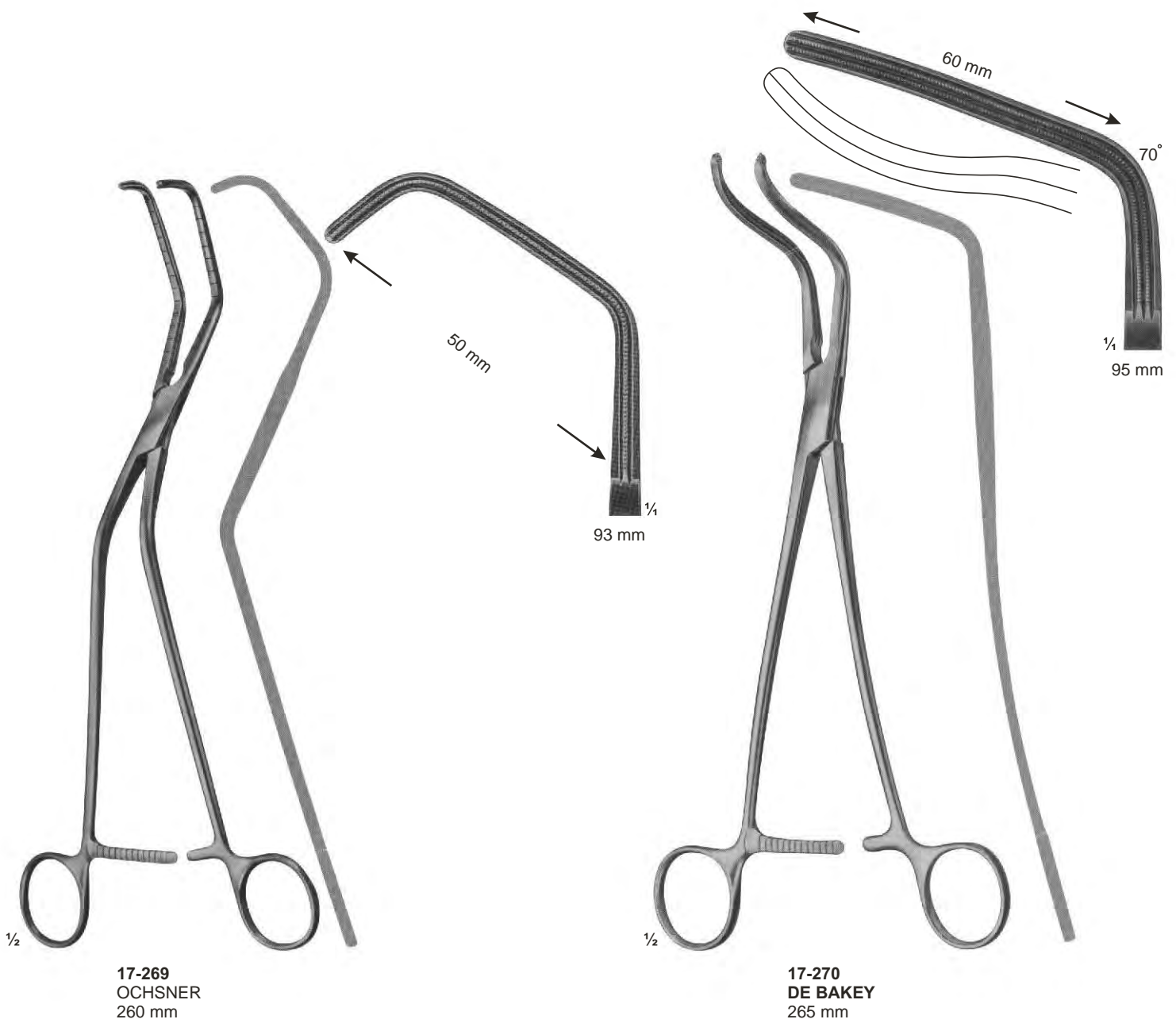

Aorta-Anastomosis Clamps

**REALSTAR SURGICAL
INSTRUMENTS**

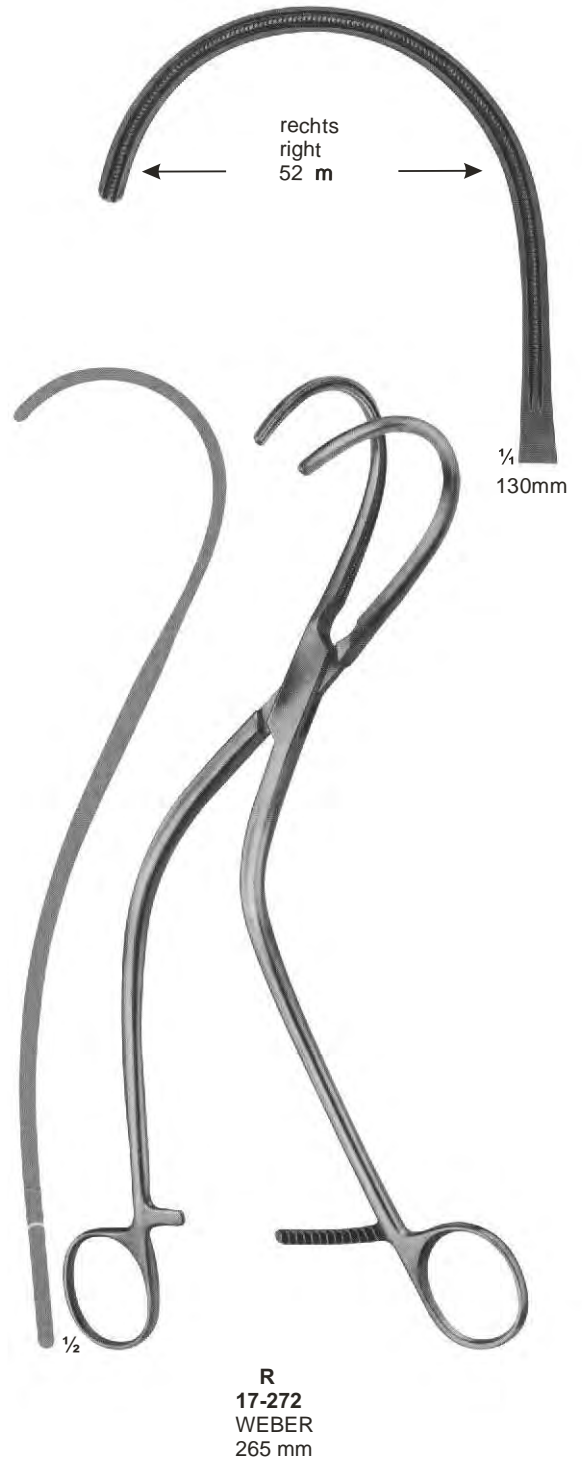
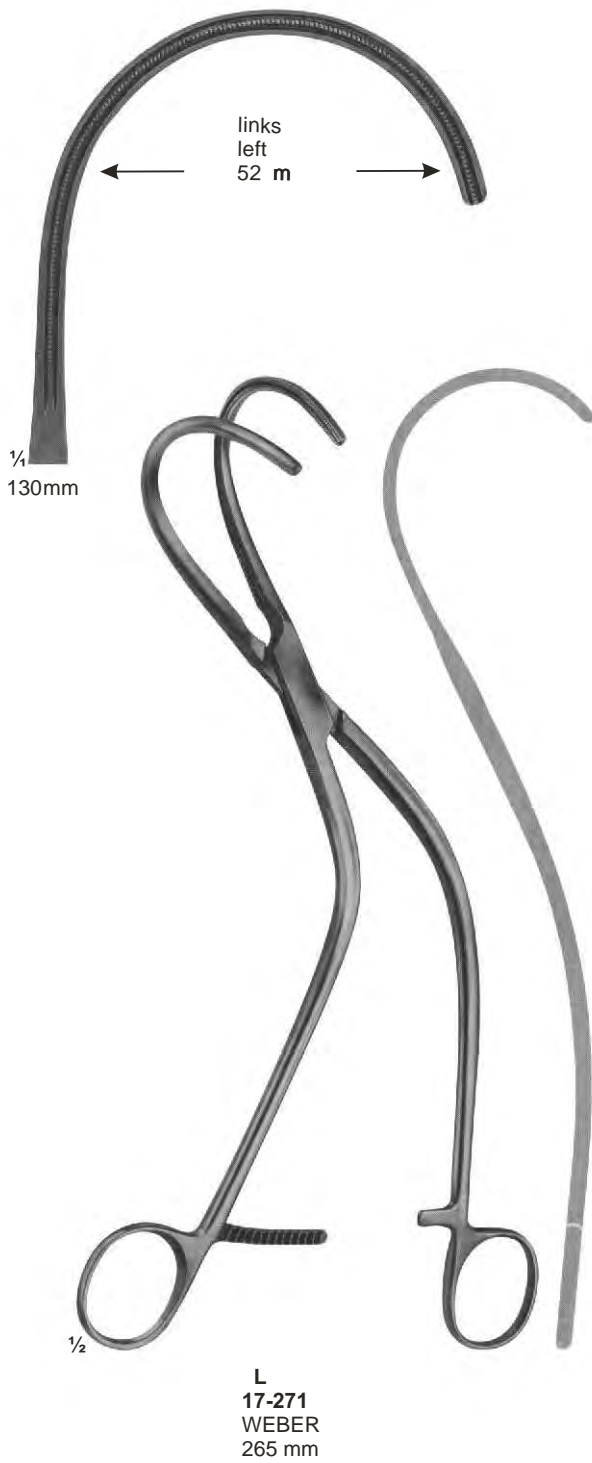

**REALSTAR SURGICAL
INSTRUMENTS**

SERVING TO SAVE LIVES

Aorta-Anastomosis Clamps

REALSTAR SURGICAL INSTRUMENTS



1/2
17-273 - 276
DE BAKY

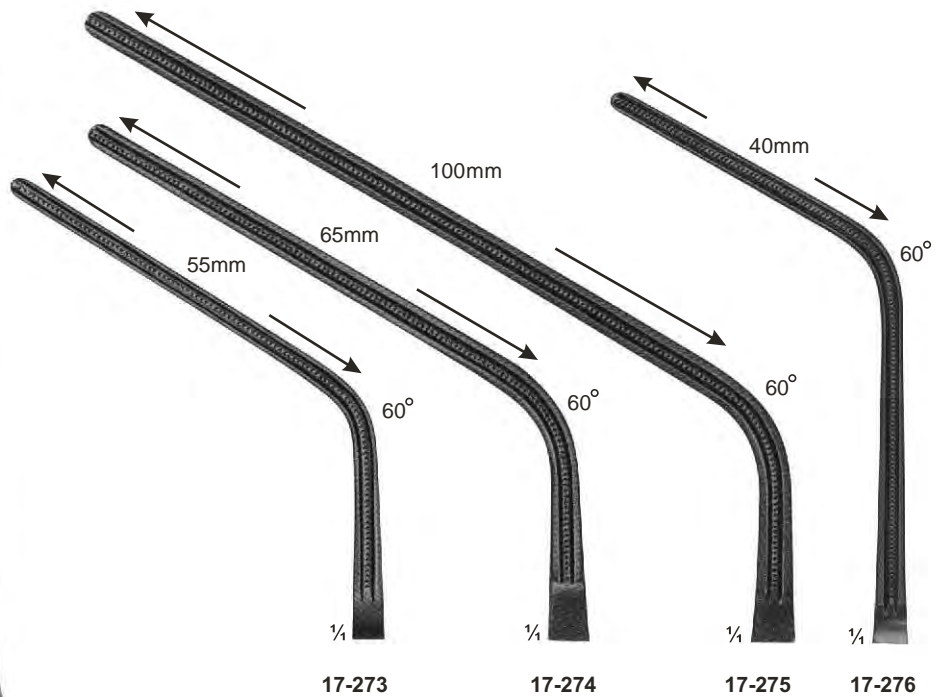

Total Length: 230 mm 280 mm 305 mm 240 mm
Length of jaws: 85 mm 100 mm 135 mm 93 mm



1/2
17-277 - 280
DE BAKY

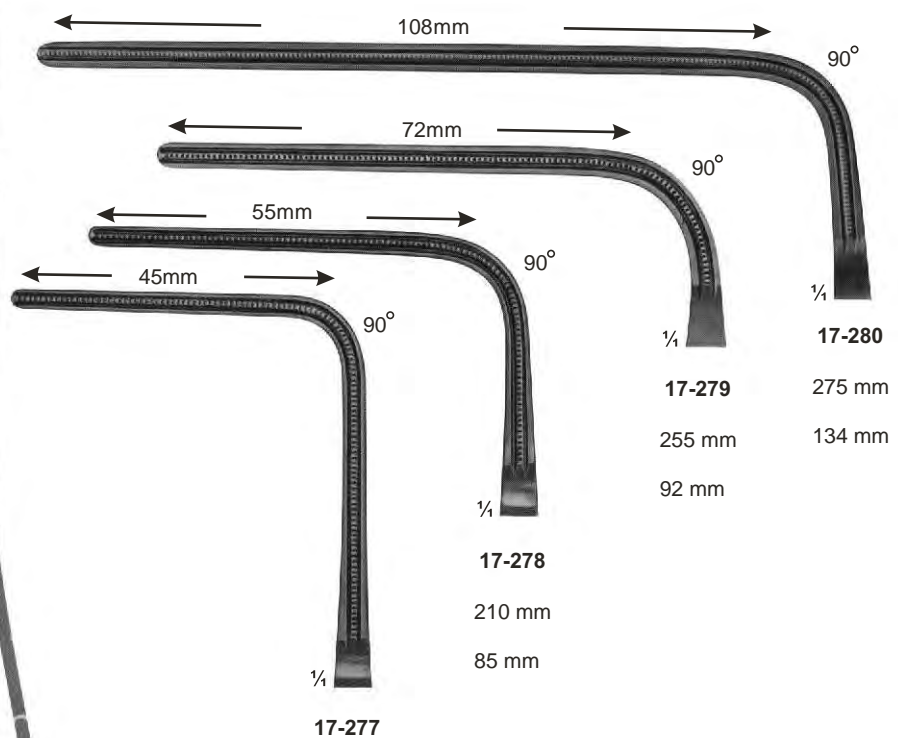

Total Length: 225 mm 210 mm 255 mm 275 mm
Length of jaws: 93 mm 85 mm 92 mm 134 mm

Aorta-Anastomosis Clamps

REALSTAR SURGICAL INSTRUMENTS



17-281
50mm

17-282
50mm

17-281 - 282
COOLEY
125 mm, 115 mm



17-283
COOLEY
100 mm

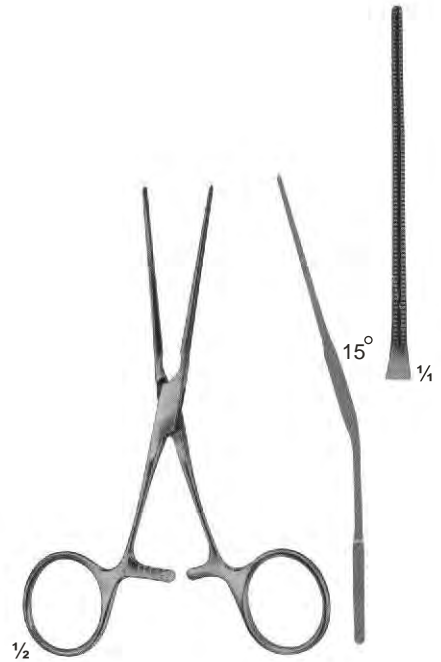

17-284
COOLEY
125 mm

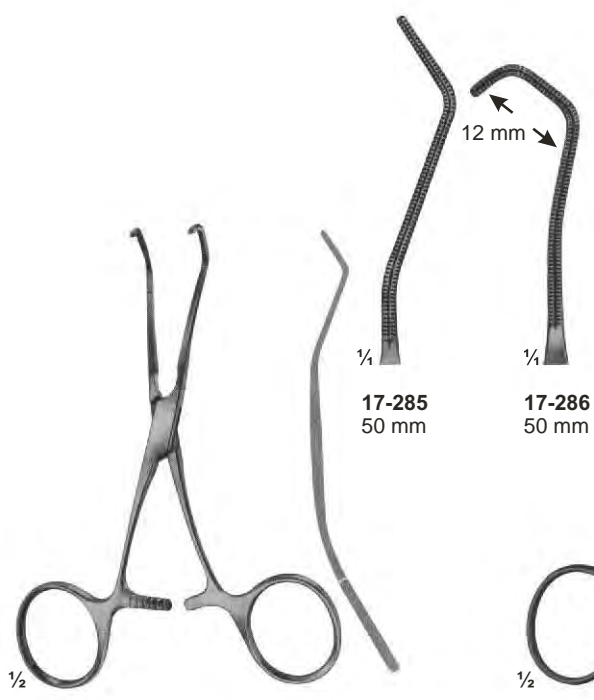

17-285
50 mm

17-286
50 mm

17-285 - 286
COOLEY
120 mm, 115 mm

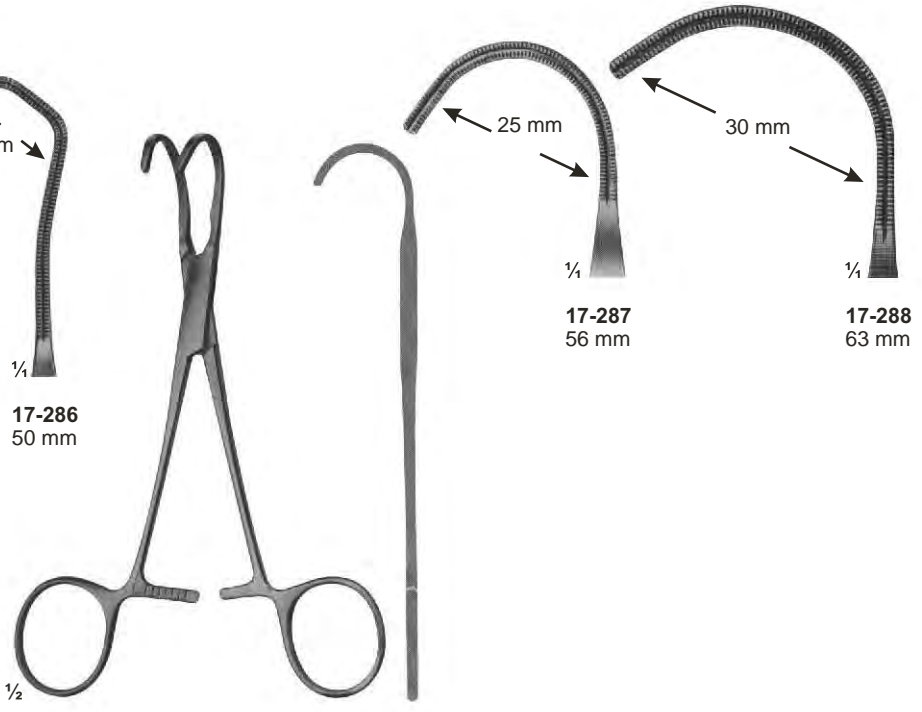

17-287
56 mm

17-288
63 mm

17-287 - 288
COOLEY-BACK
150 mm, 115 mm

Aorta-Anastomosis Clamps

REALSTAR SURGICAL INSTRUMENTS

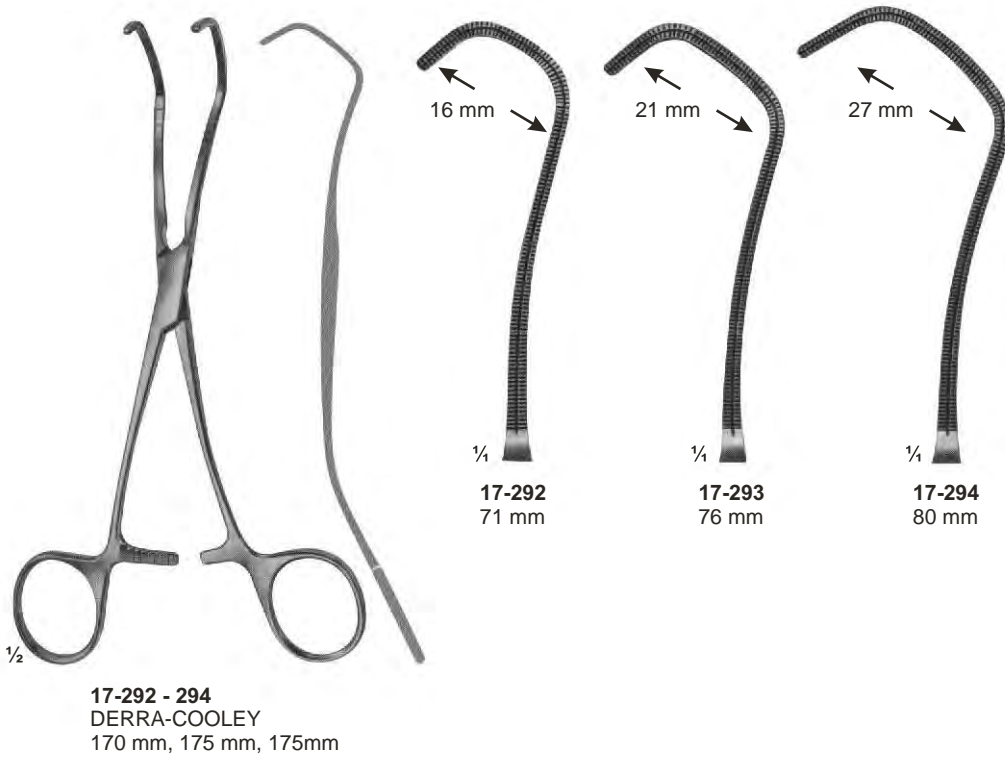
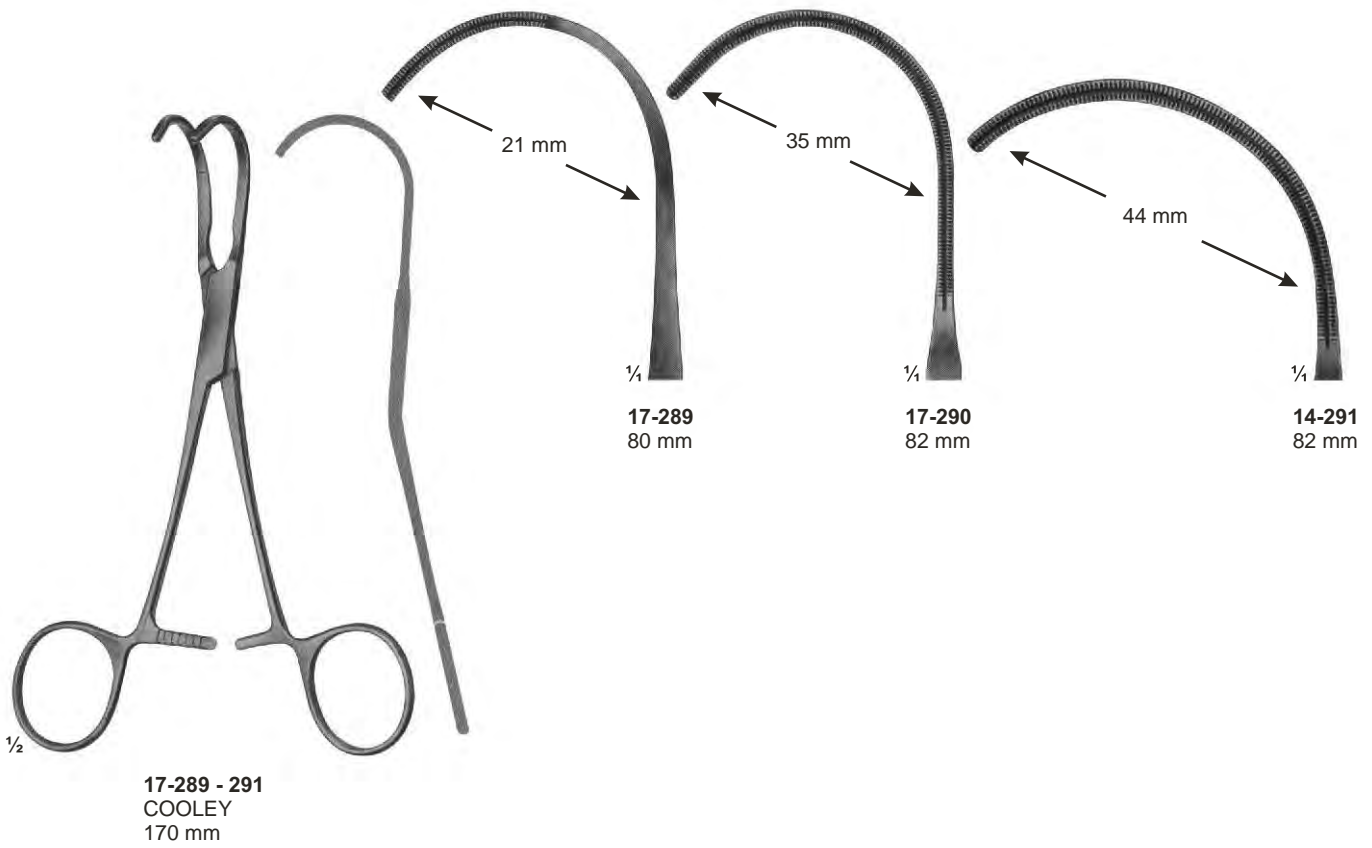

Aorta-Anastomosis Clamps

REALSTAR SURGICAL INSTRUMENTS

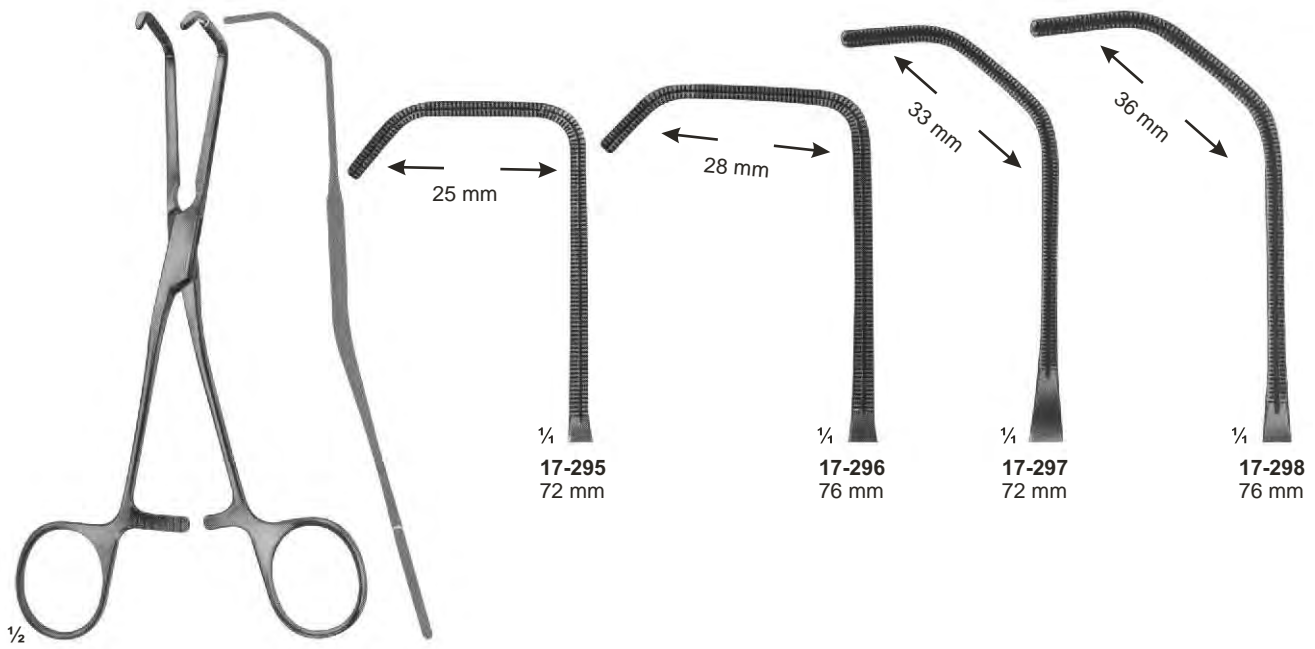

17-295 - 298
COOLEY
 165 mm, 165 mm
 175 mm, 180 mm

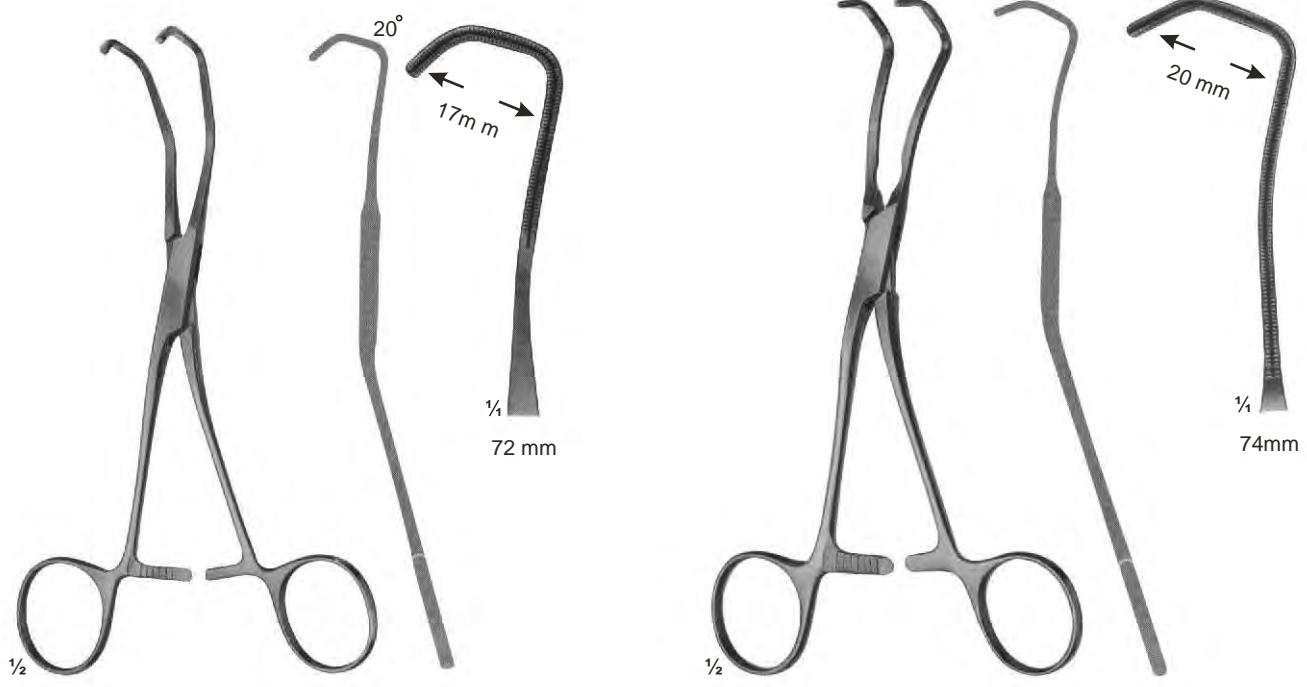

17-299
COOLEY
 170 mm

17-300
COOLEY
 175 mm

Aorta-Anastomosis Clamps

REALSTAR SURGICAL INSTRUMENTS

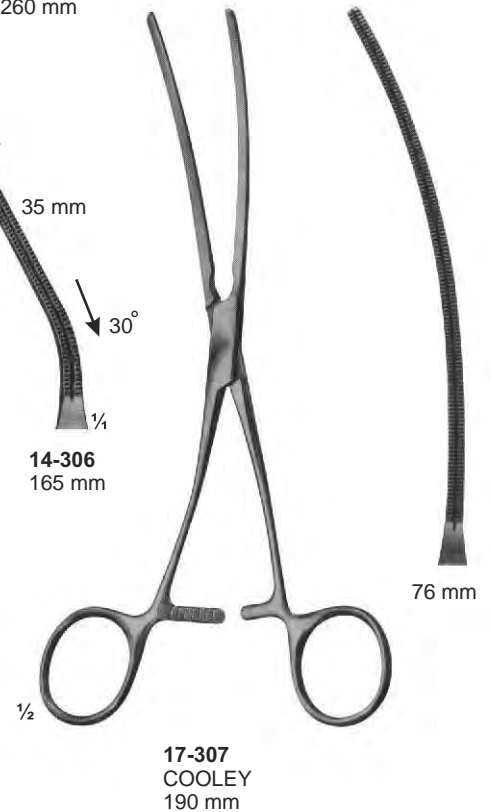
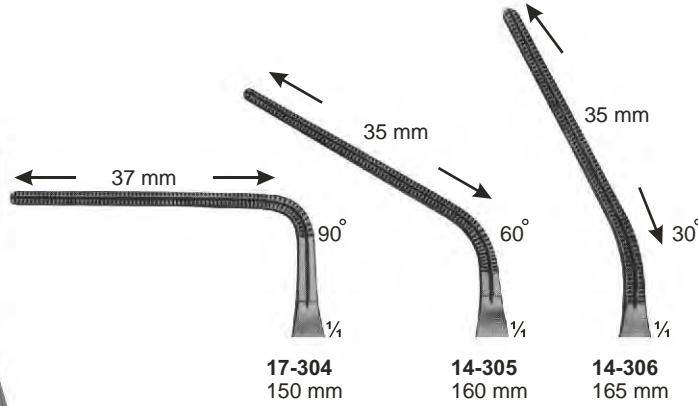
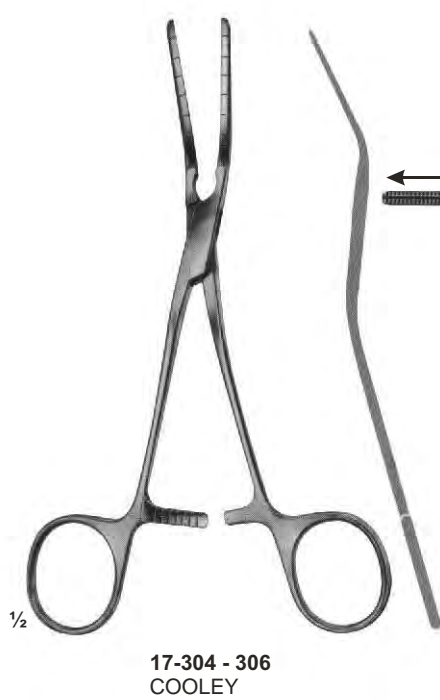
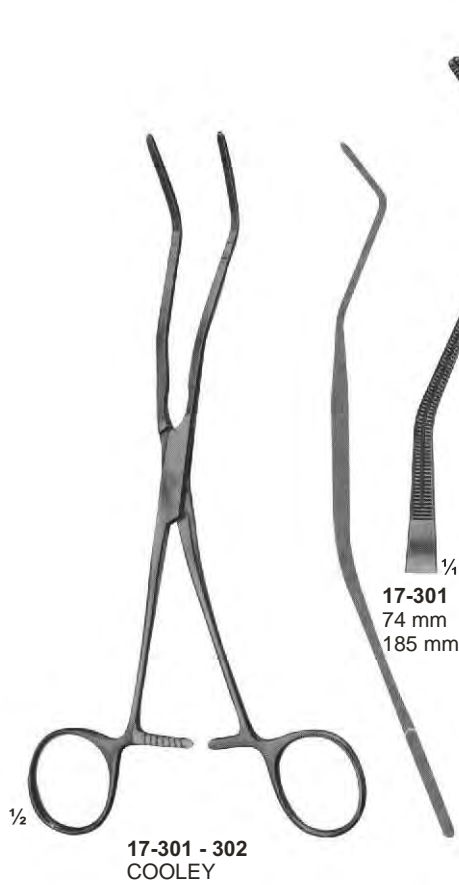

Aorta-Anastomosis Clamps

REALSTAR SURGICAL INSTRUMENTS

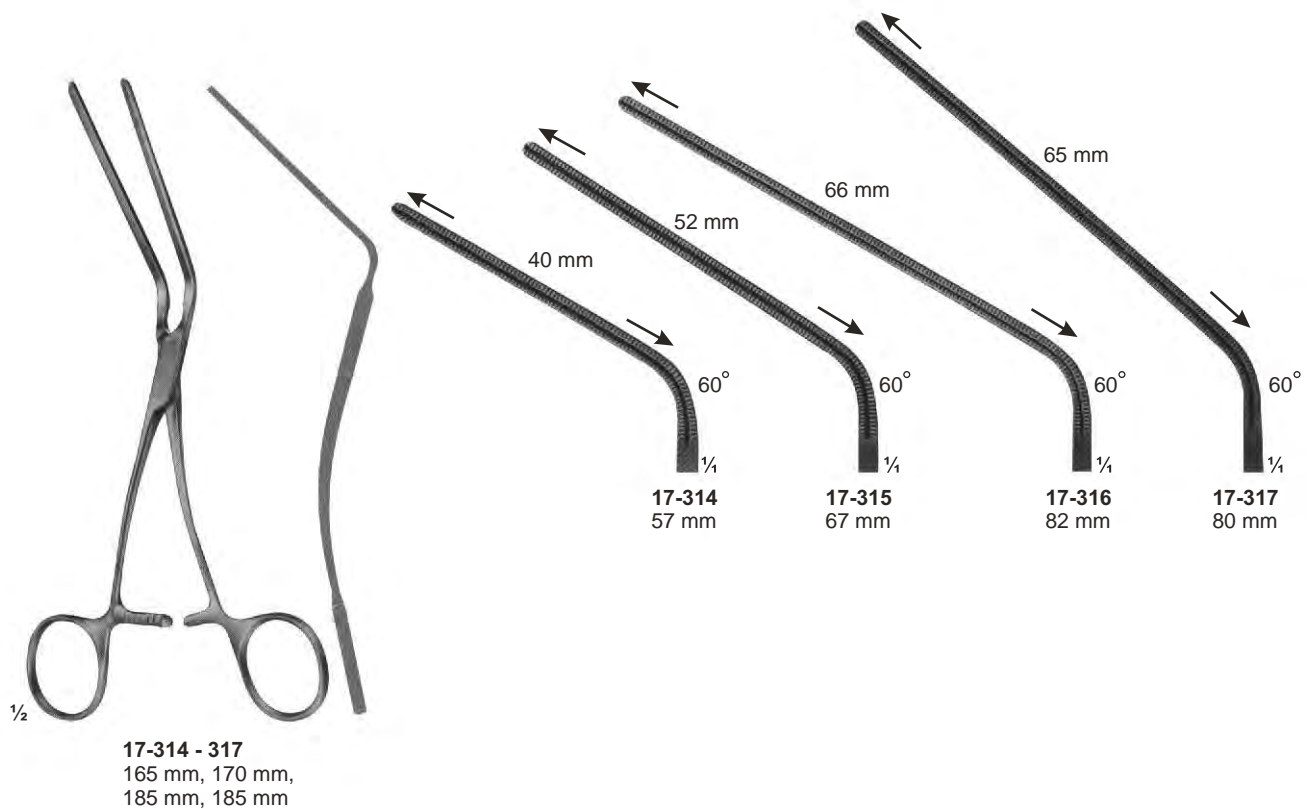
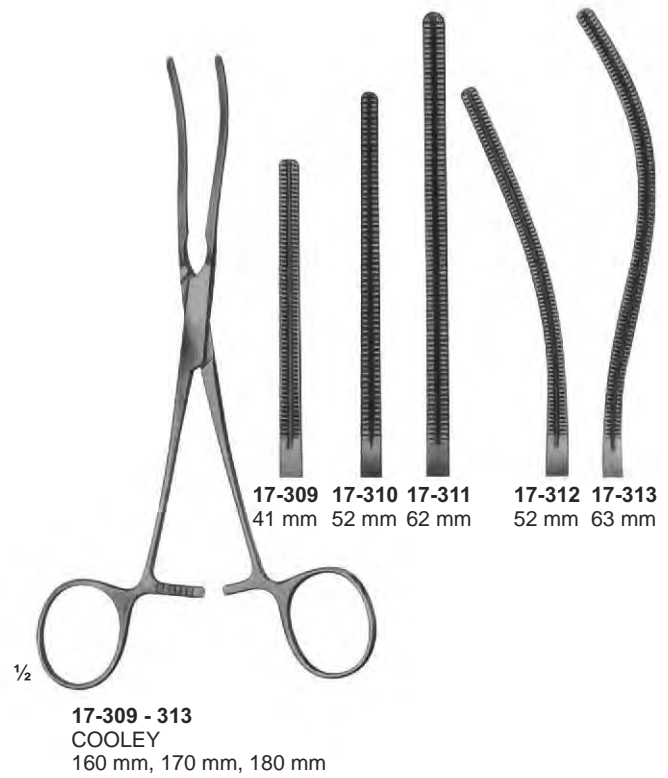
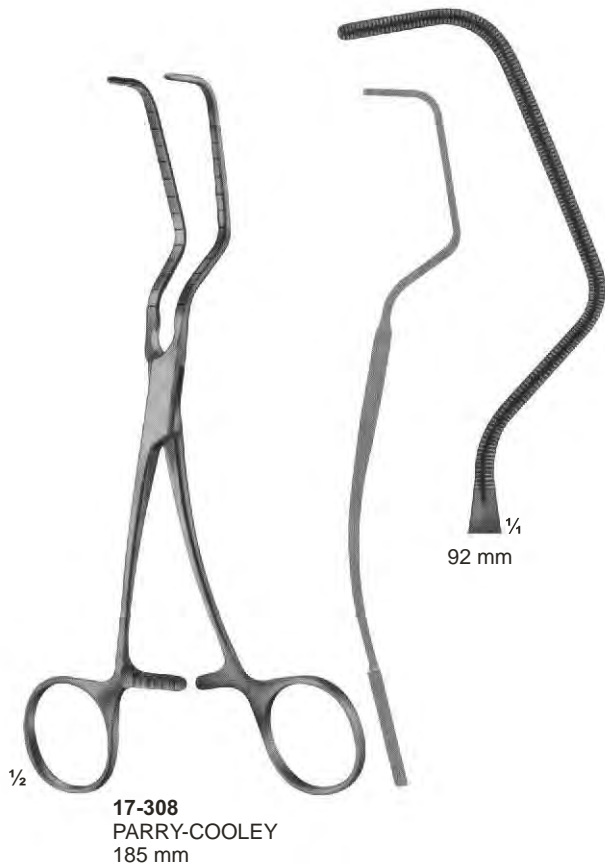

Multi-Purpose Clamps

REALSTAR SURGICAL INSTRUMENTS



DARDIK			
17-318	150 mm	17-323	170 mm
17-319	150 mm	17-324	170 mm
17-320	150 mm	17-325	170 mm
17-321	145 mm	17-326	160 mm
17-322	130 mm	17-327	135 mm

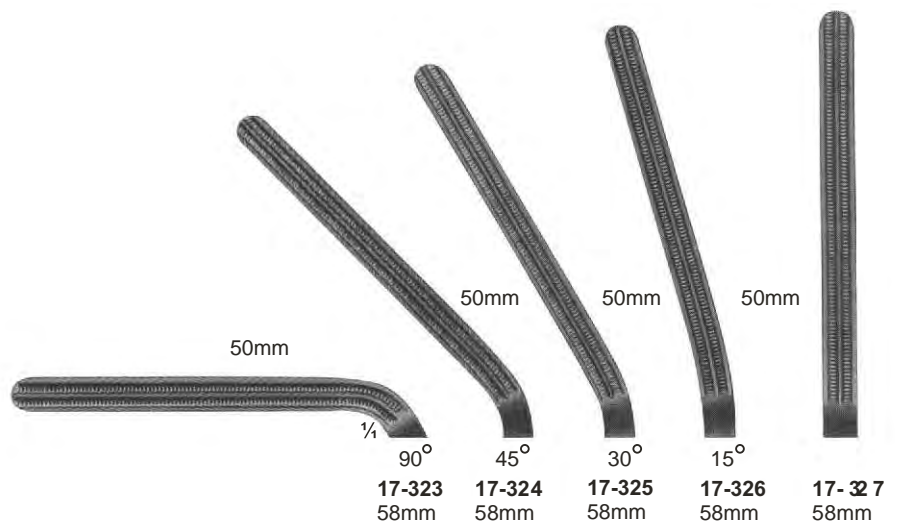
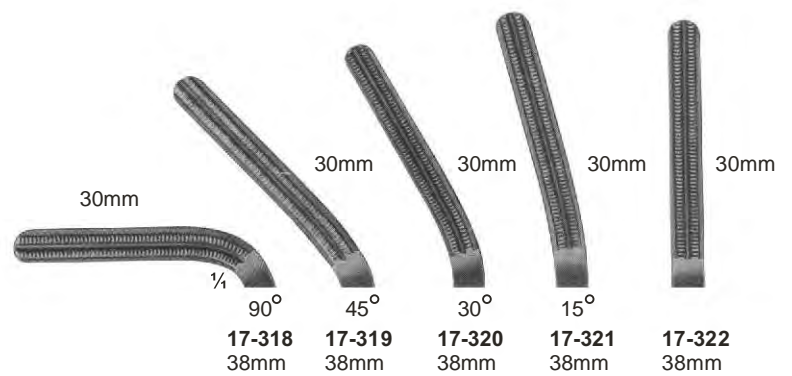

Multi-Purpose Clamps

REALSTAR SURGICAL INSTRUMENTS

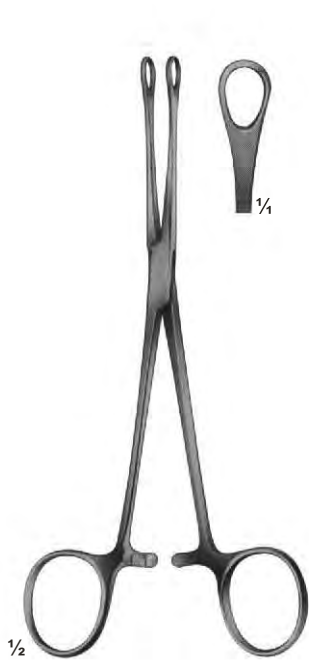

17-328
WILLIAMS
160 mm



17-329
TUTTLE
230 mm



17-330
NELSON
230 mm

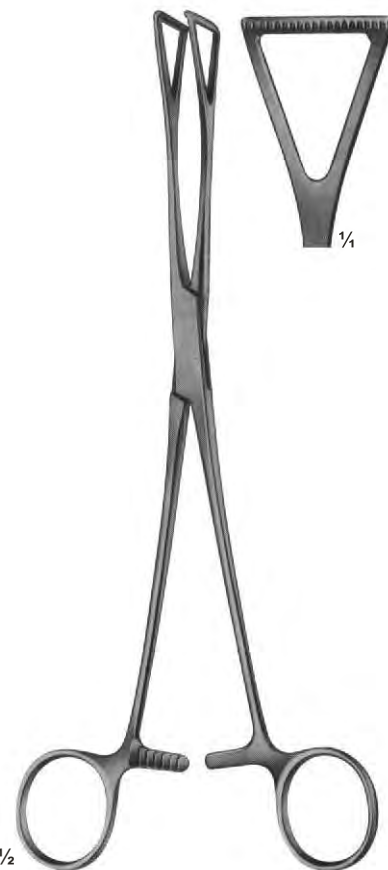

17-331
DUVAL
230 mm

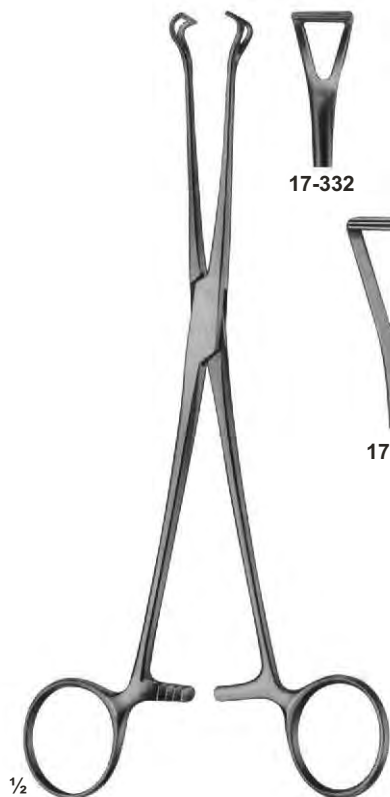

BABCOCK
17-332 170 mm
17-333 215 mm
17-334 220 mm

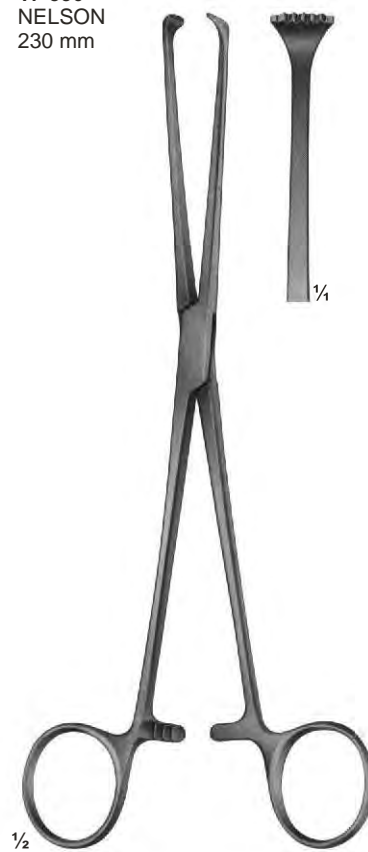

17-335
ALLIS
220 mm

Multi-Purpose Clamps

**REALSTAR SURGICAL
INSTRUMENTS**

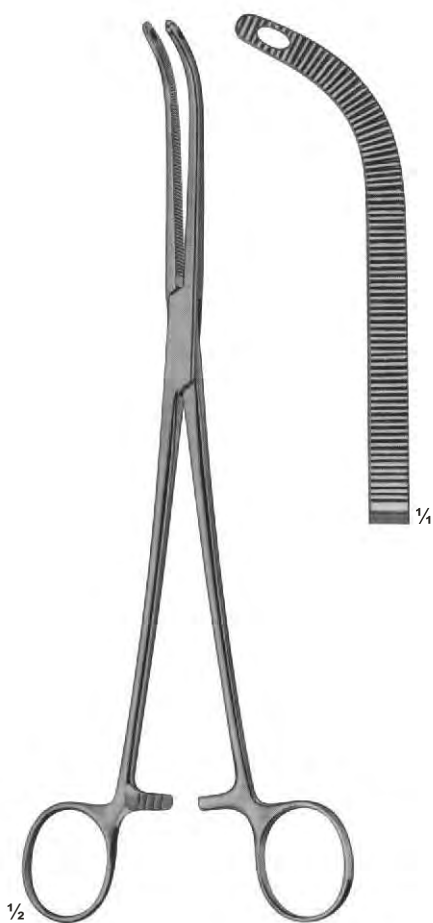

**17-336
FINOCHIETTO**
245 mm

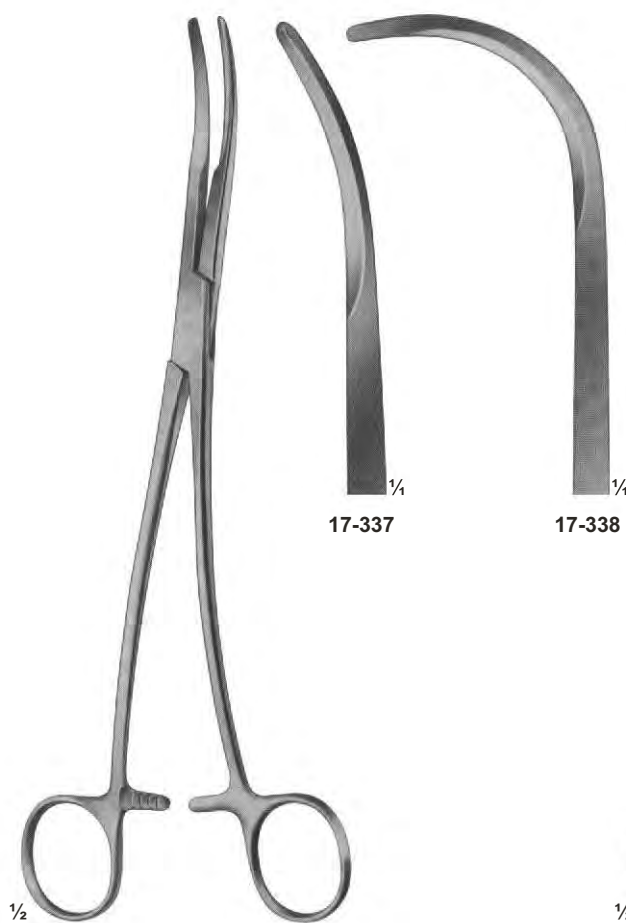

17-337

17-338

**17-337 - 338
SEMB**
244 mm



**17-339
WIKSTROEM**
205 mm

**REALSTAR SURGICAL
INSTRUMENTS**

SERVING TO SAVE LIVES

Multi-Purpose Clamps

REALSTAR SURGICAL INSTRUMENTS



17-340
MIXTER
230 mm



17-341 - 342
MIXTER

17-341
220 mm

17-342
250 mm



17-343
HOPFNER
160 mm

Multi-Purpose Clamps

REALSTAR SURGICAL INSTRUMENTS

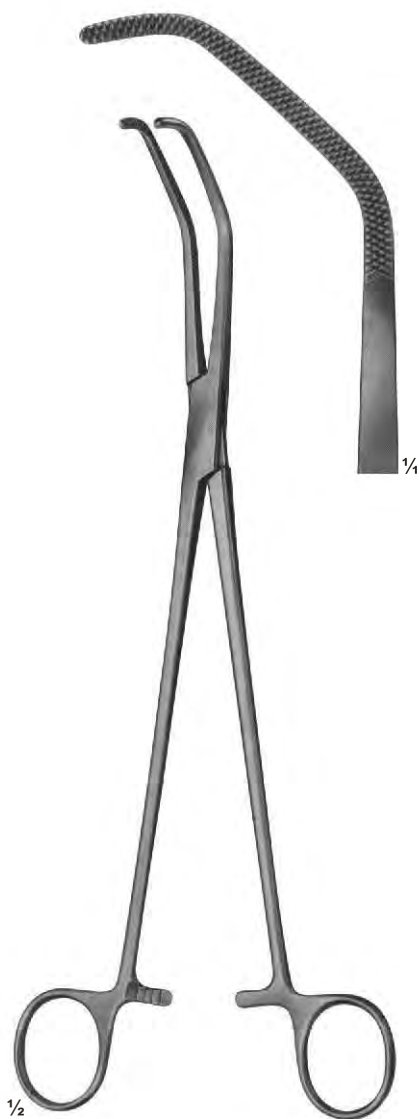

17-344
SATINSKY
265 mm



17-345
SATINSKY
265 mm

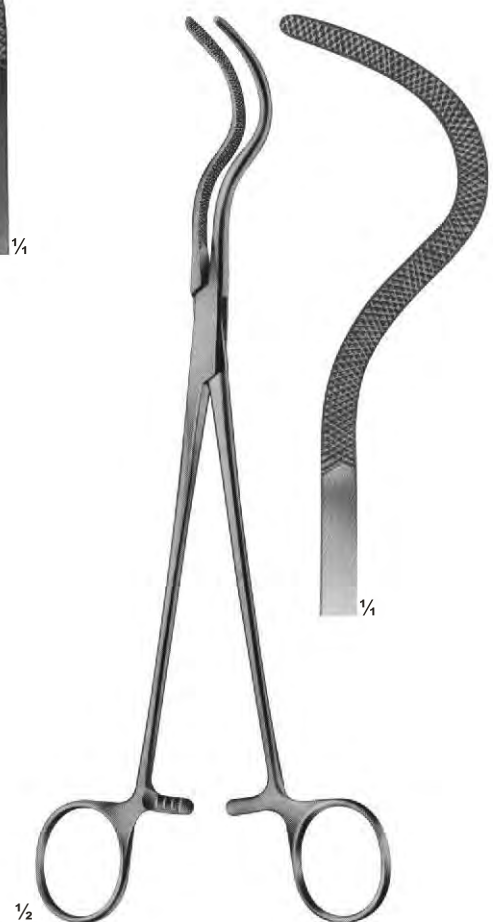

17-346
HARKEN
240 mm

Multi-Purpose Clamps

REALSTAR SURGICAL INSTRUMENTS



17-347
PERTUISET
Carotid Clamp
90 mm

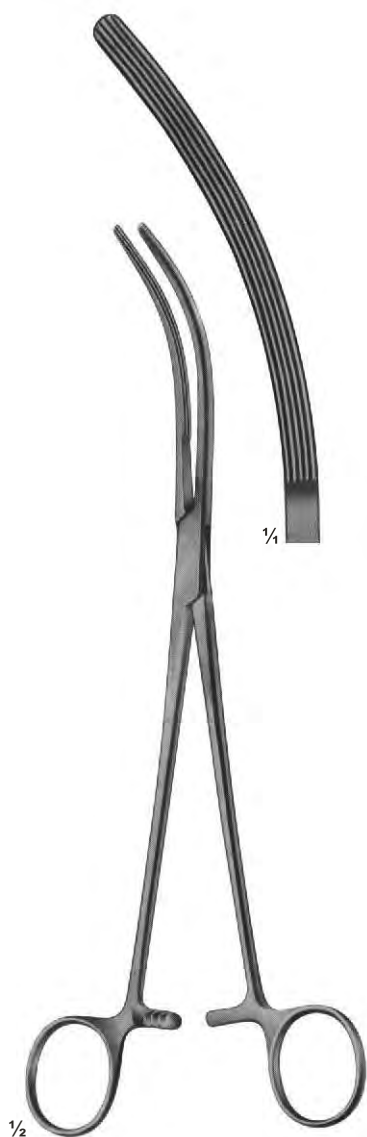

17-348
CRAFOORD-SELLORS
240 mm



17-349 - 350
CRAFOORD
240 mm

Multi-Purpose Clamps

REALSTAR SURGICAL INSTRUMENTS



17-351
PRICE THOMAS
225 mm



17-352
jaws with pins

17-353
jaws with pins

17-352 - 353
PRICE THOMAS
225 mm

Rib Shears

REALSTAR SURGICAL INSTRUMENTS



17-354
SCHUMACHER
Sternum shears
210 mm



17-355
LEBSCHÉ
Sternum chisel
200 mm



17-356
230 mm



17-357
COLLIN
195 mm



17-358
GLUCK
190 mm



17-359
GLUCK
190 mm



17-360
BRUNNER
Universal Pattern
340 mm



17-361
GIERTZ-STILLE
250 mm

Rib Holding Forceps, Bone Cutting Forceps

REALSTAR SURGICAL INSTRUMENTS



17-362
SEMB
Rib-and Bone
Holding forceps
190 mm



17-363
SEMB
Rib-and Bone
Holding forceps
190 mm

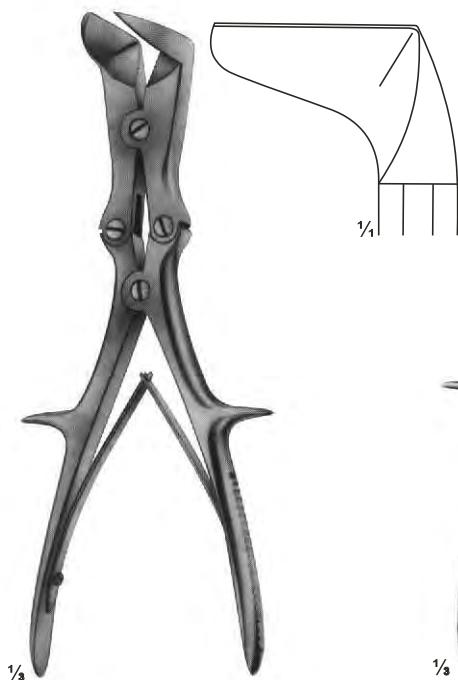

17-364
LISTON-STILLE
265 mm

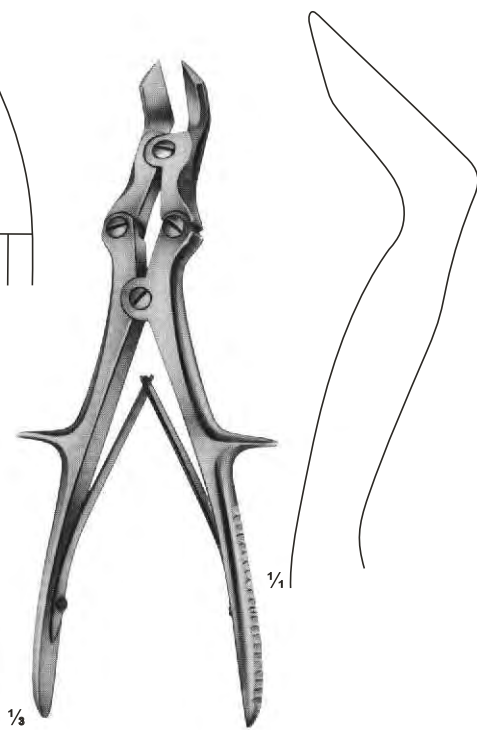

17-365
LISTON-KEY-HORSLEY
255 mm

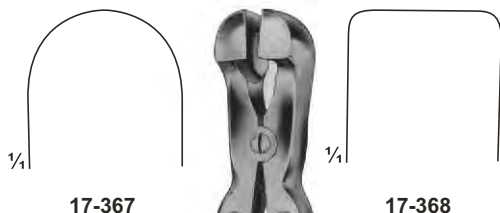

17-367

17-368

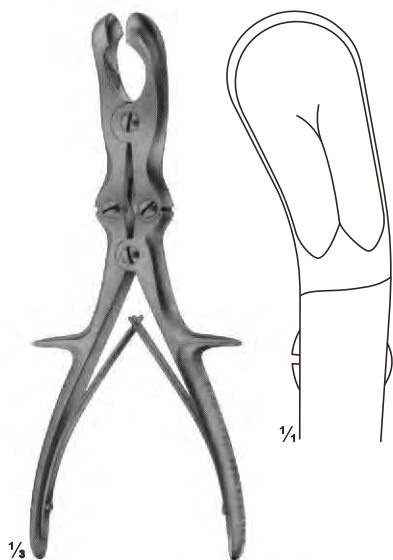

17-366
SEME
Rib Rongeur to shorten
the rib stumps
240 mm



17-367-368
SAUERDRUCH-CORYLLOS
Rib rongeurs to shortn
the rib stumbes
310 mm

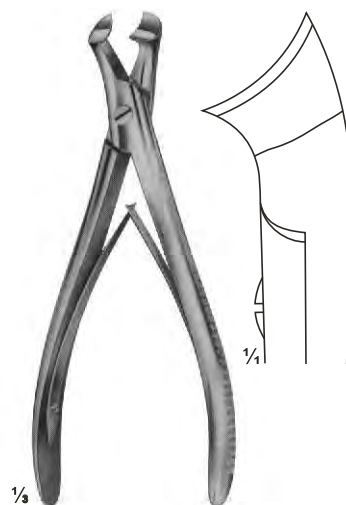

17-369
MARKWALDER
Rib Rongeur to Round
the rib stumps
190 mm

Rib Raspatories

REALSTAR SURGICAL INSTRUMENTS



17-370

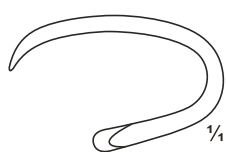

17-371



1/2

17-370 - 371
DOYEN
for children
175 mm



17-372



17-373



1/2

17-372 - 373
DOYEN
for adults
175 mm

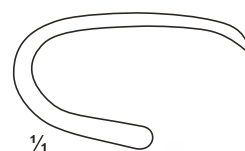

17-374

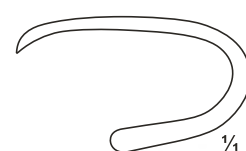

17-375



1/2

17-374 - 375
DOYEN
240 mm



Rib Raspatories

REALSTAR SURGICAL INSTRUMENTS



1/2
17-376 - 380
SEMB
230 mm

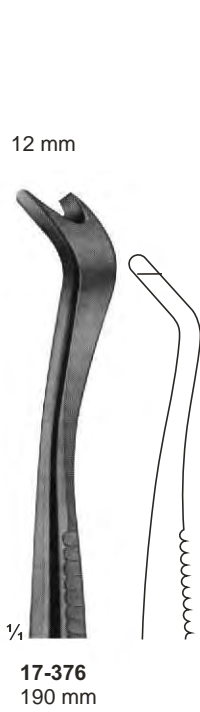

12 mm
17-376
190 mm



12 mm
17-377



13 mm
17-378



13 mm
17-379



15 mm
17-380



1/2
17-381
LANGENBECK
190 mm



17-382 5 mm
17-383 10 mm
17-384 15 mm
17-385 20 mm
17-386 25 mm

1/2
17-382 - 386
LAMBOTTE
215 mm



1/2
17-387
ALEXANDER
210 mm

Rib Spreaders

REALSTAR SURGICAL INSTRUMENTS

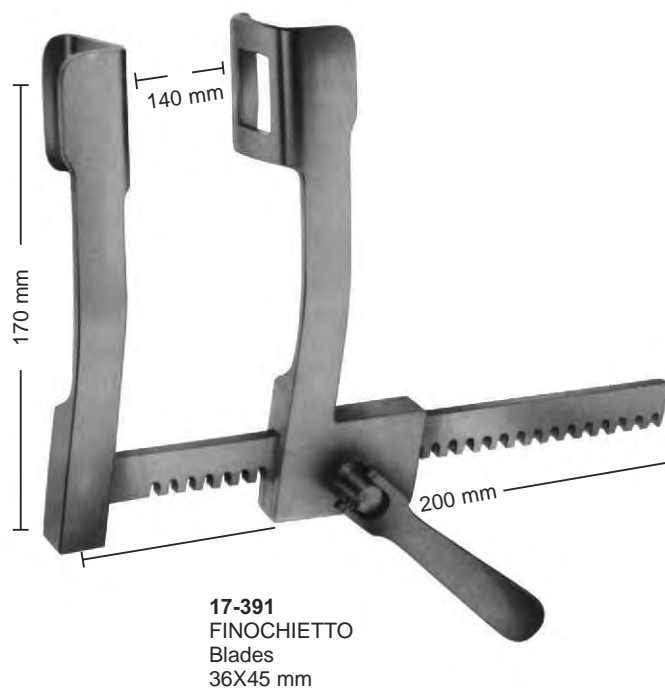
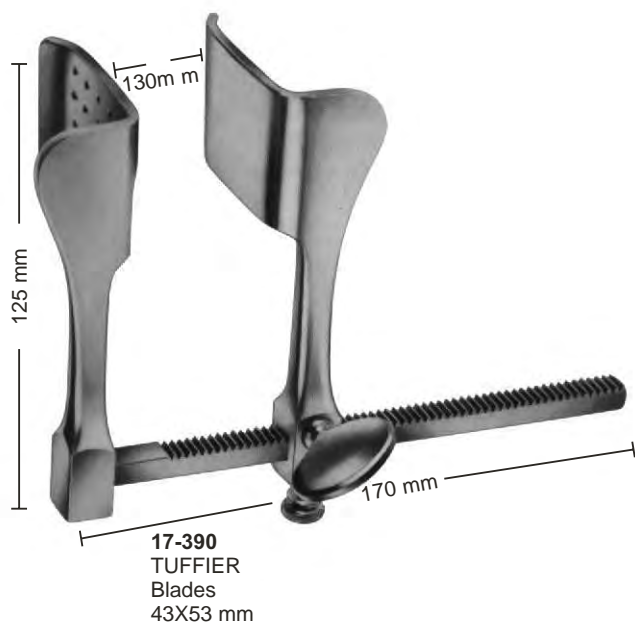
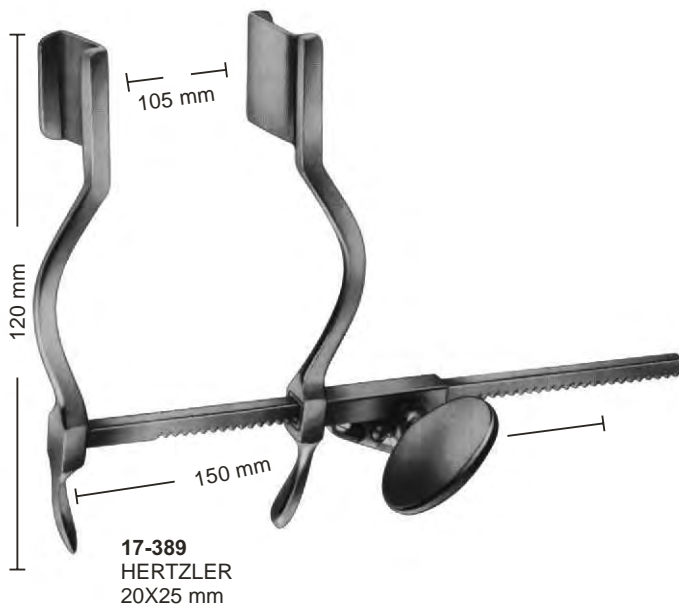
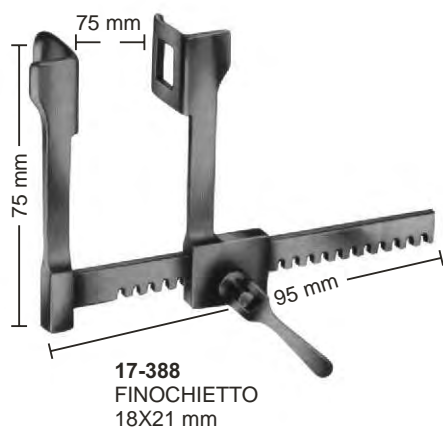

Rib Spreaders

REALSTAR SURGICAL INSTRUMENTS

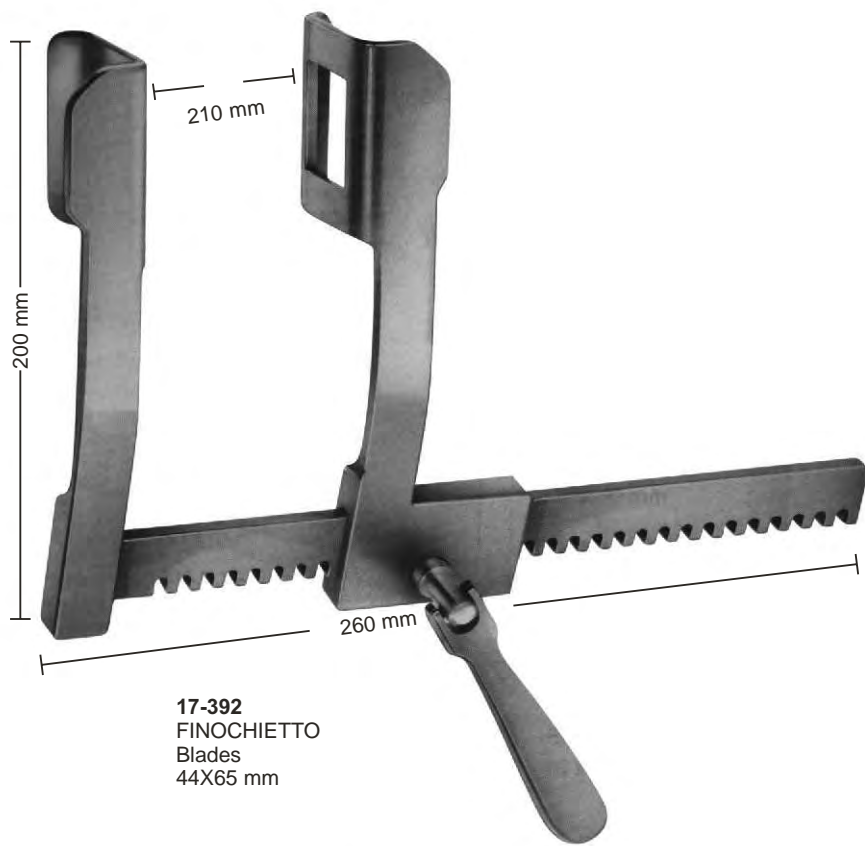

17-392
FINOCHIETTO
Blades
44X65 mm

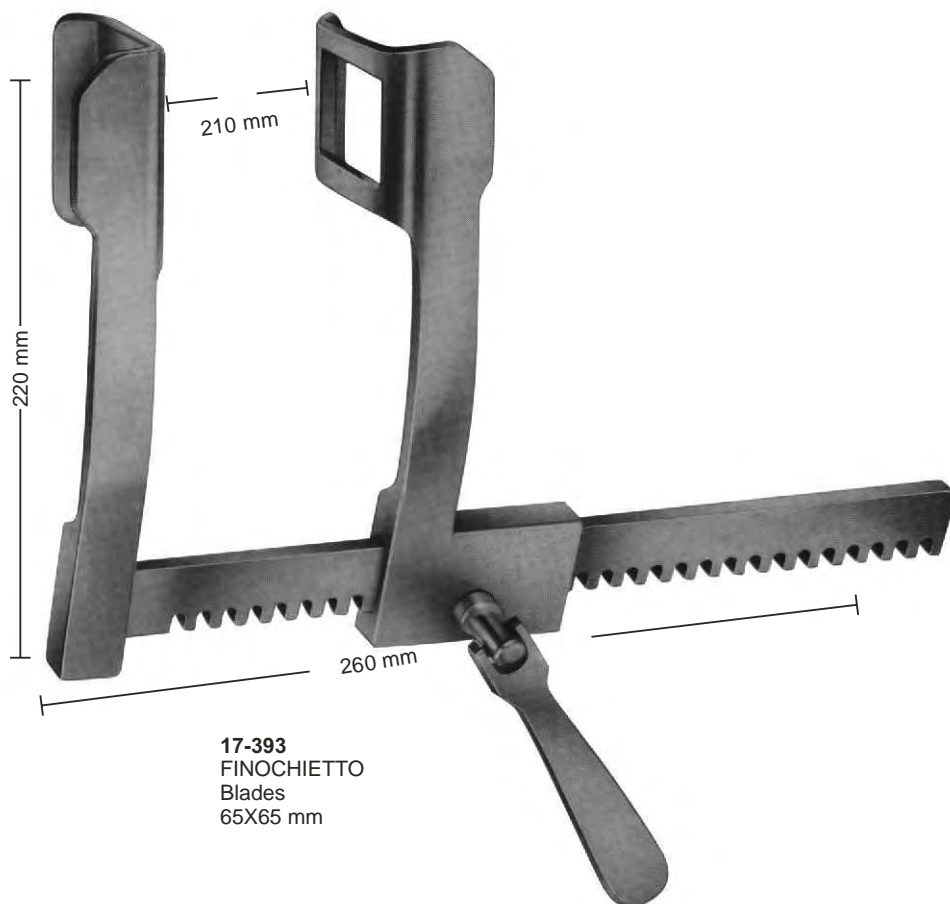

17-393
FINOCHIETTO
Blades
65X65 mm

Rib Spreaders

REALSTAR SURGICAL INSTRUMENTS



17-395
Blades
46x67 mm



17-396
Blades
80x67 mm



17-397
Blades
46x67 mm



17-398
Blade, Only, for preparation
of a. Mammaria, 25.5x80mm

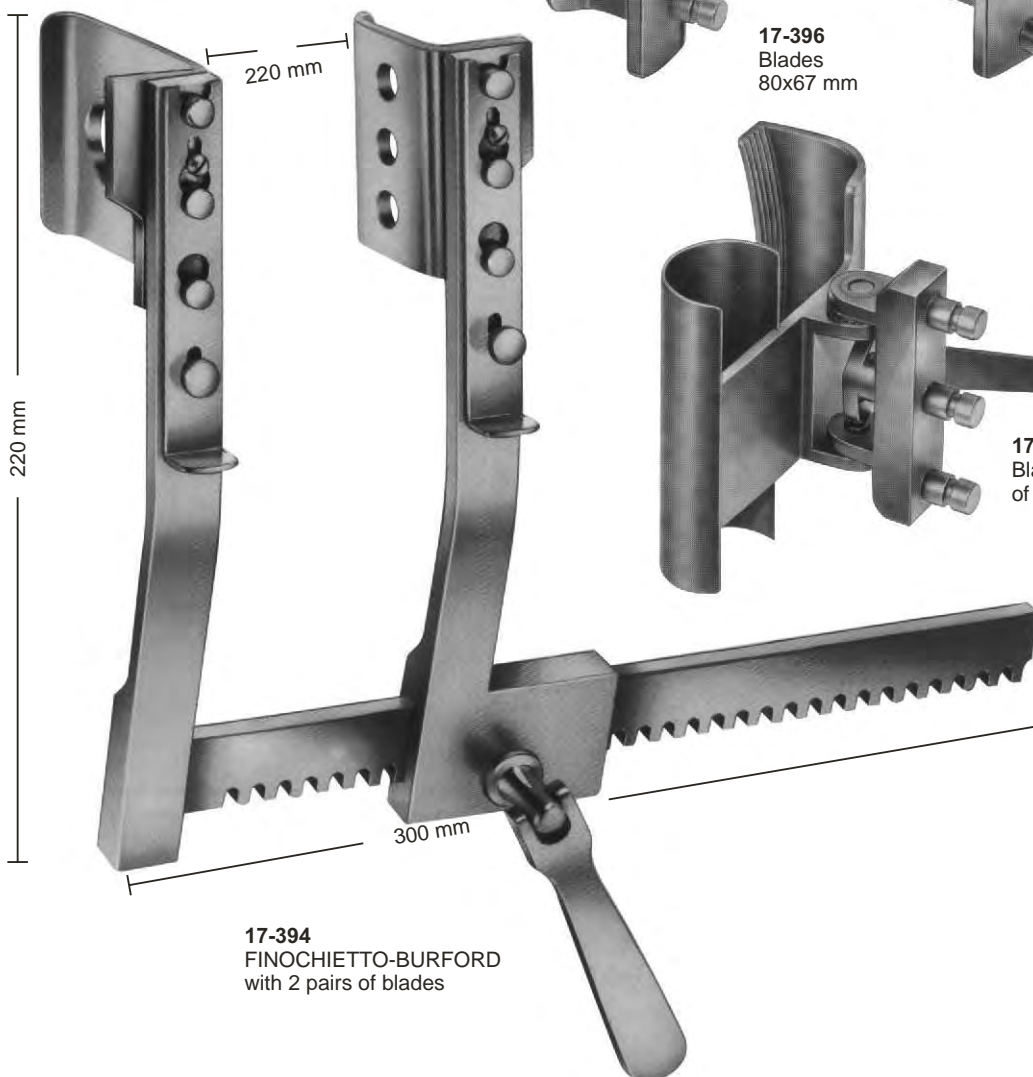
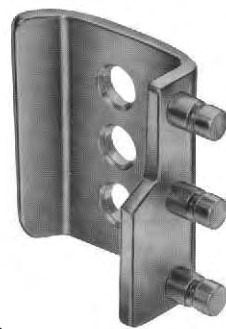

17-394
FINOCHIETTO-BURFORD
with 2 pairs of blades

Rib Spreaders

REALSTAR SURGICAL INSTRUMENTS

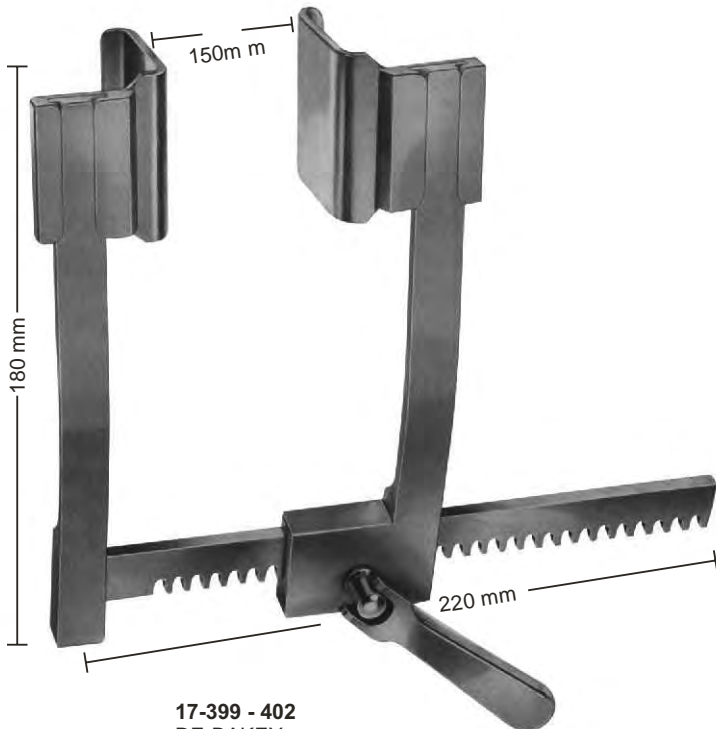

17-399 - 402
DE-BAKEY
with 3 pairs of blades

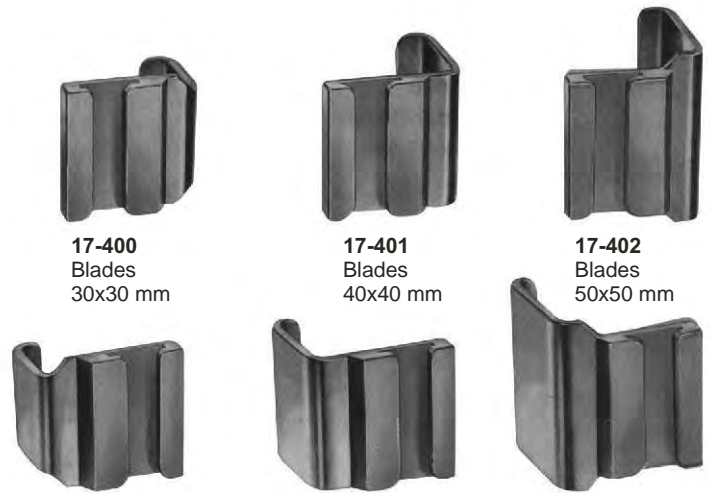

17-400
Blades
30x30 mm

17-401
Blades
40x40 mm

17-402
Blades
50x50 mm

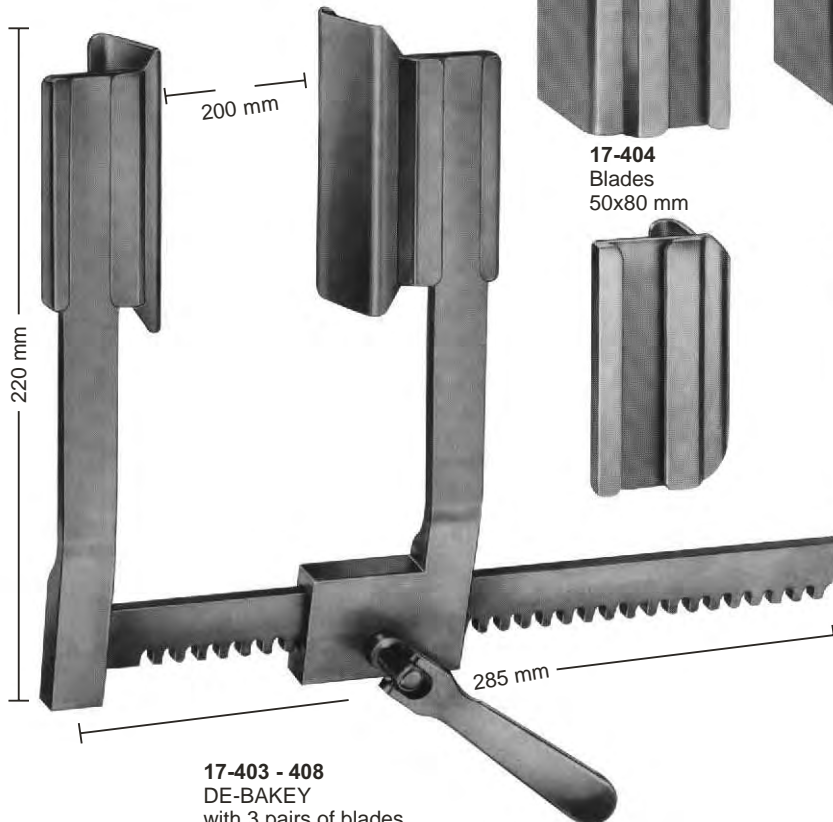

17-403 - 408
DE-BAKEY
with 3 pairs of blades

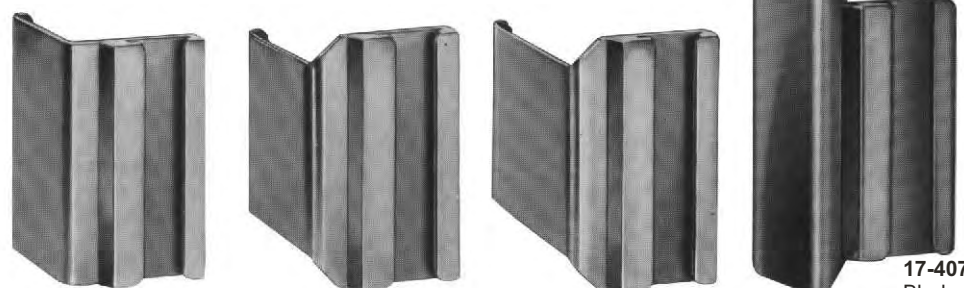

17-404
Blades
50x80 mm

17-405
Blades
80x60 mm

17-406
Blades
50x80 mm

17-407
Blades
40x100 mm

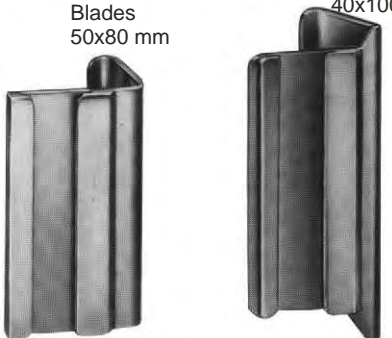

17-408
Sternotomy Blades
50x660 mm

Sternotomy Spreaders

**REALSTAR SURGICAL
INSTRUMENTS**

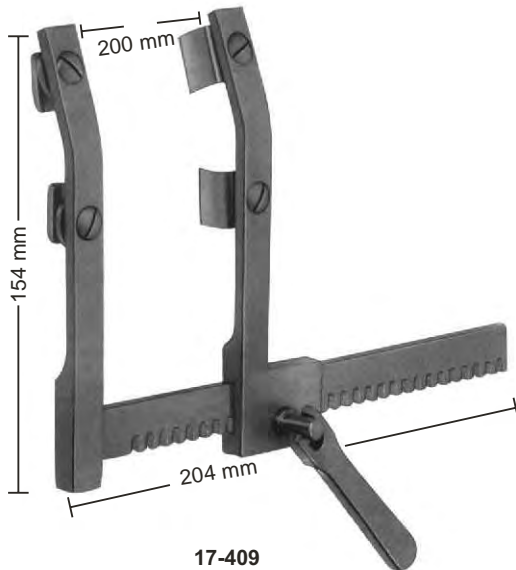

17-409
MORSE
Sternotomy spreader
for children, with moveable
double, each blade
12x20 mm

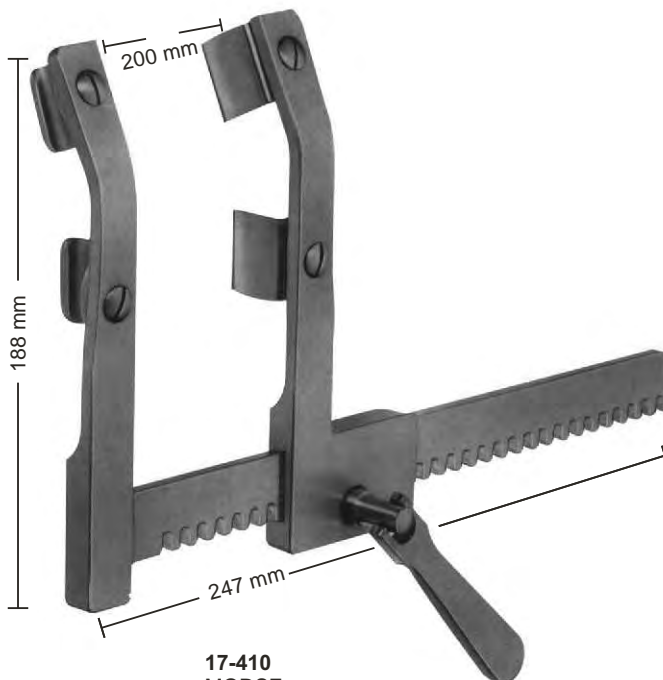

17-410
MORSE
Sternotomy spreader
for adults, with moveable
double, each blade
19x19 mm

Sternotomy- Spreaders

**REALSTAR SURGICAL
INSTRUMENTS**

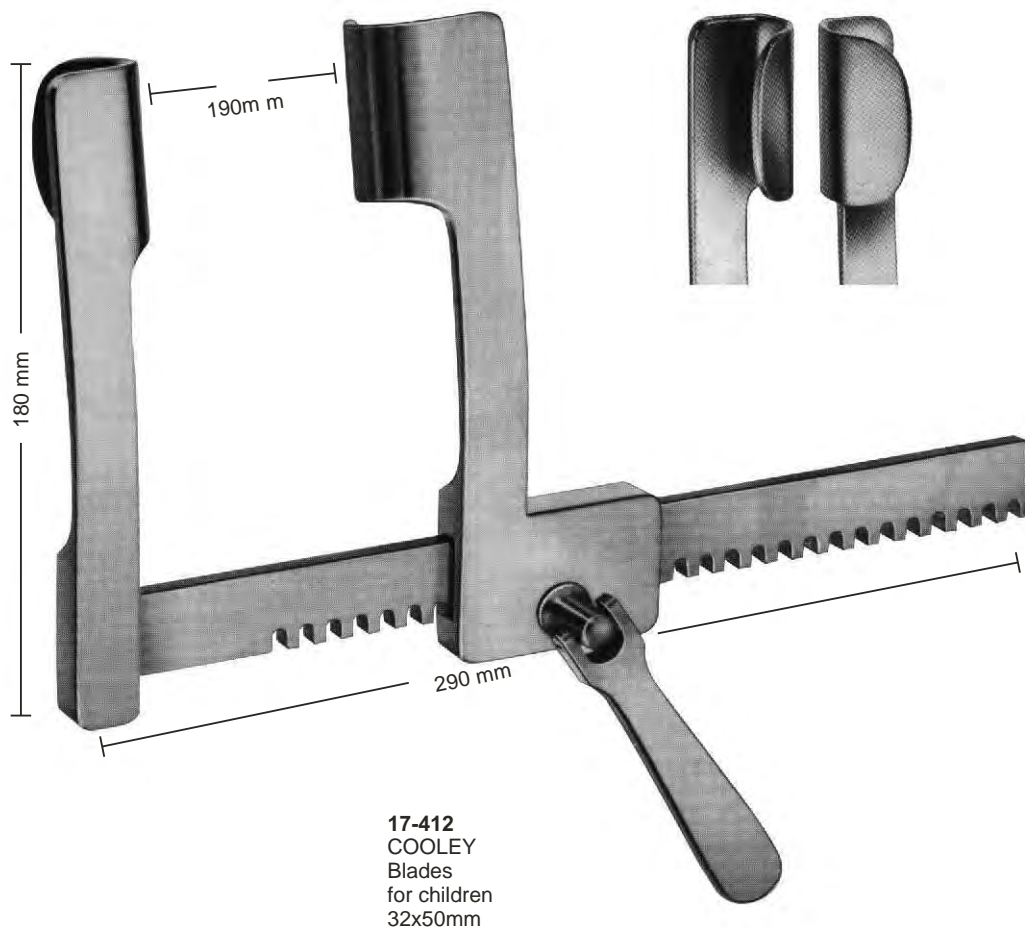
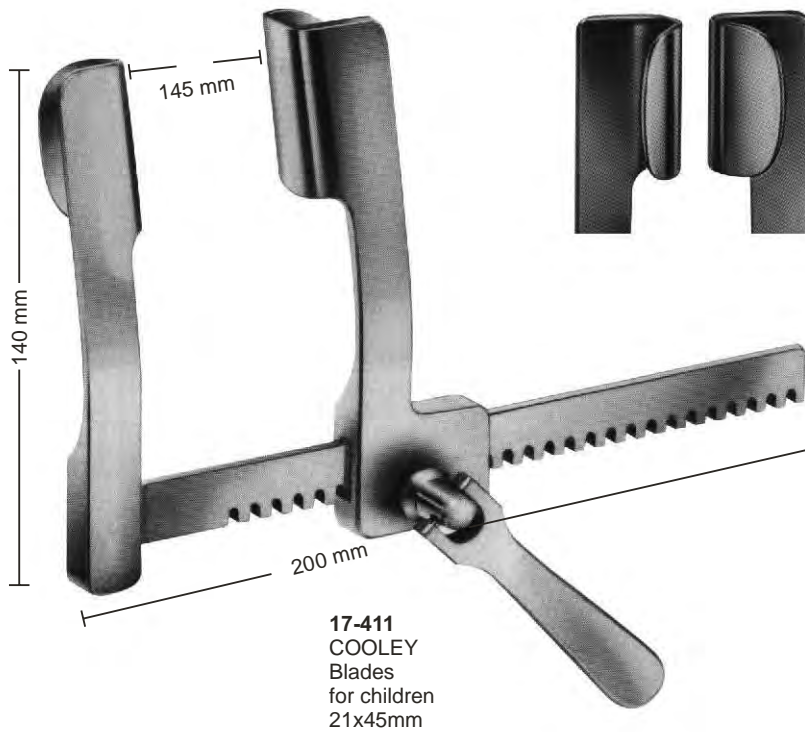

**REALSTAR SURGICAL
INSTRUMENTS**

SERVING TO SAVE LIVES

Thoracic Retractors

REALSTAR SURGICAL INSTRUMENTS



17-414
Blades
75x75 mm



17-415
Blades
42x65 mm

Blades with Ball Snap System
Delivery: in Pairs

17-413 - 415
Thoraxsperrer (Mercedes-Sperrer)
complete consisting of:
17-413 Retractor only
17-414 1 Pair of blades 42x65 mm
17-415 1 Pair of blades 75x75 mm



17-416
SELLORS
Rib spreader-and contractor
with swivel blades
200 mm



17-417
BAILEY
150 mm



17-418
for children

17-419
for children

17-418 - 419
BAILEY
200 mm

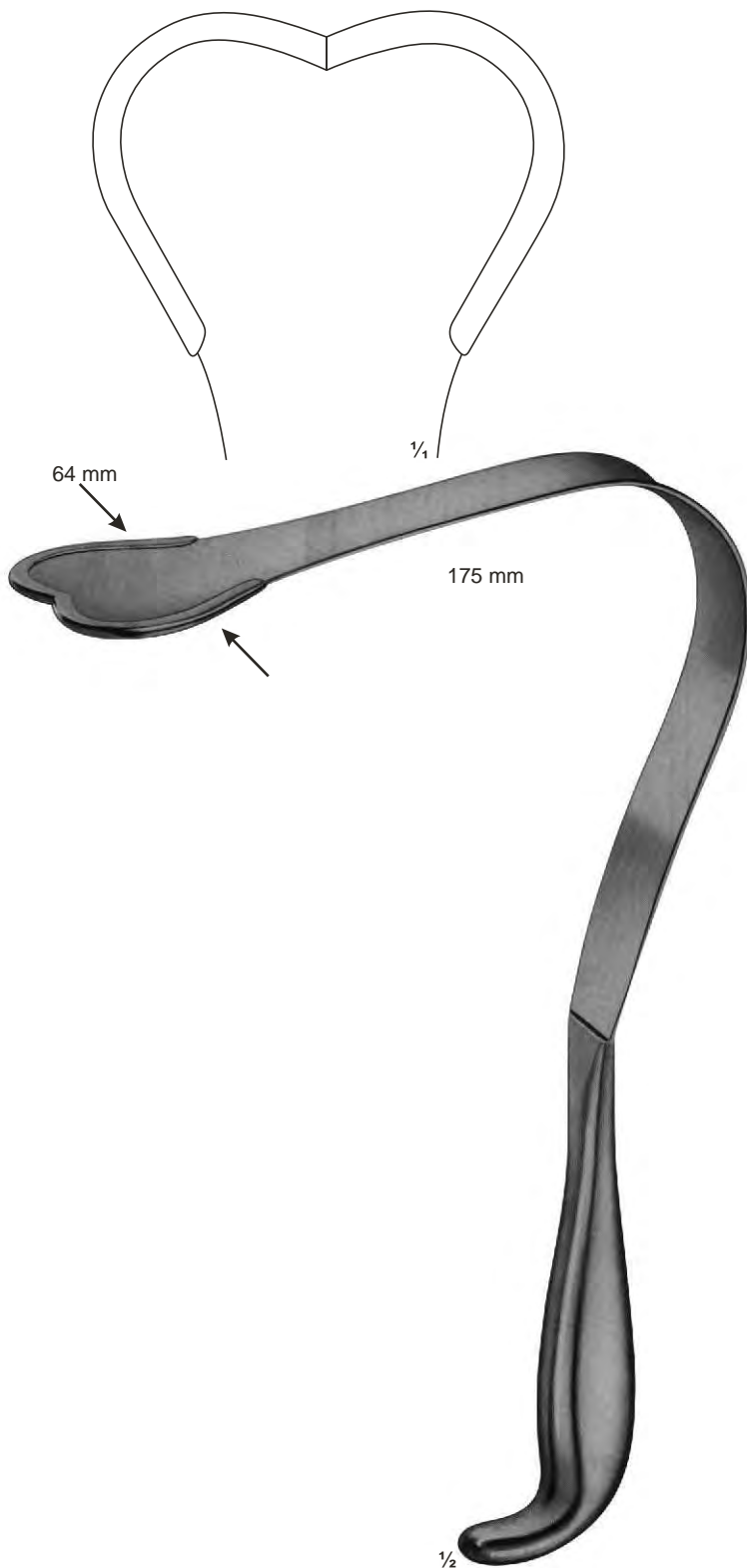

17-420
HARRINGTON-PEMBERTON
federnd/flexible
295 mm

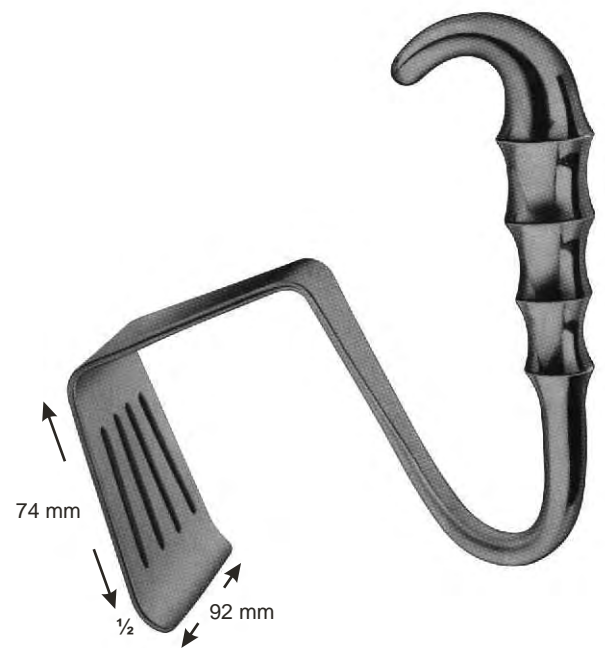

17-421
DAVIDSON
Scalpel haken



17-422
ALLISON
255 mm



17-423
ALLISON
320 mm



17-424
DE BAKEY
With central bore,
3.0mm diam.
with lateral slots
275 mm



17-425
YANKAUER
With central bore,
2.0mm diam.
285 mm

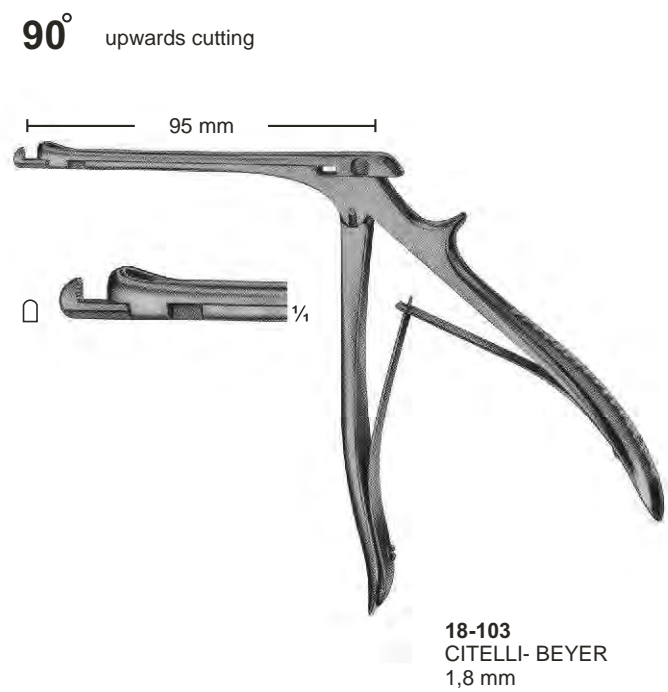
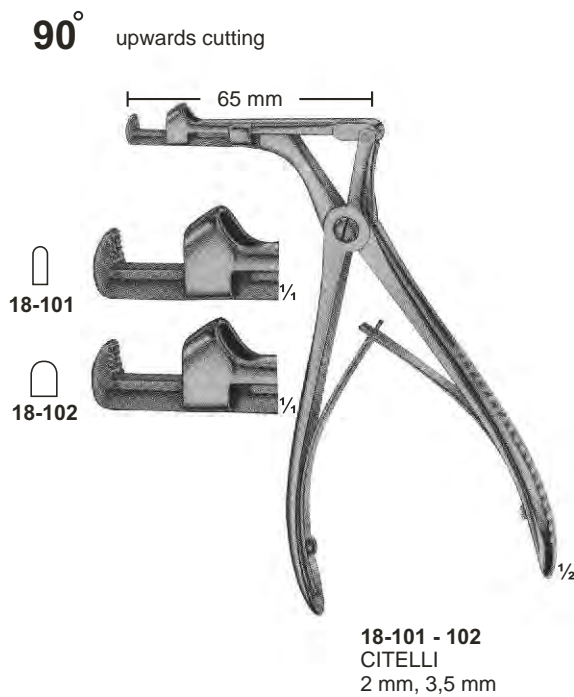
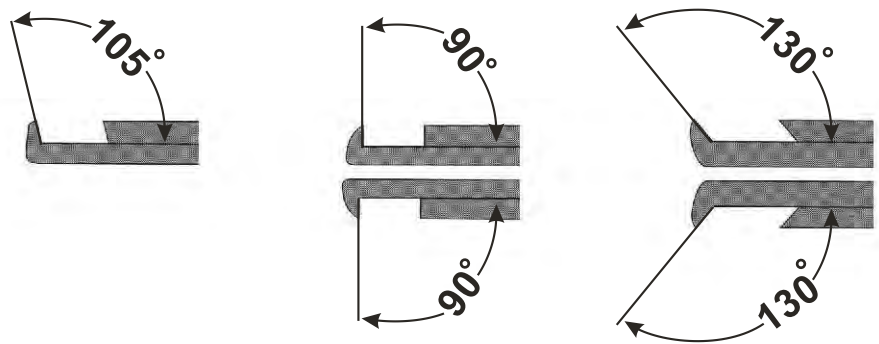

Punches

REALSTAR SURGICAL INSTRUMENTS

90° upwards cutting

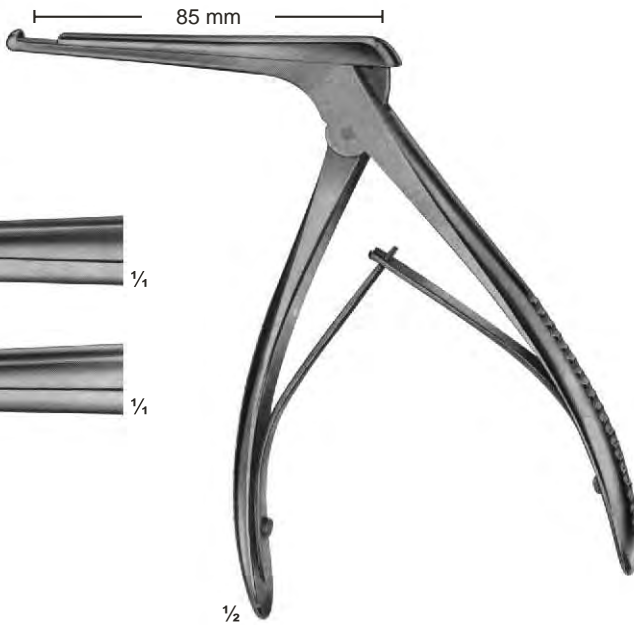

18-104
4 mm



1/4

18-105
5 mm



1/4

18-104 - 105
KERRISON

90° upwards cutting

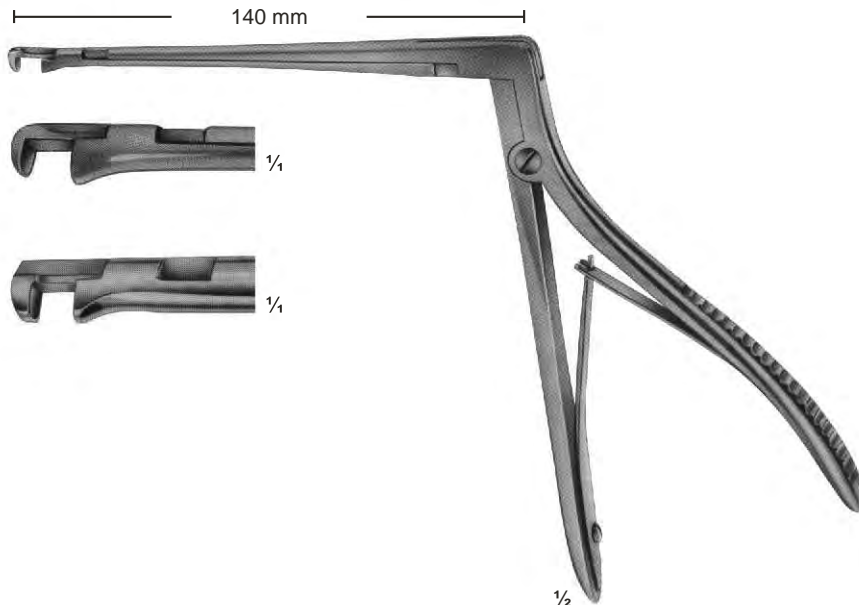

18-106
3,3 mm



1/4

18-107
4,0 mm



1/4

18-106 - 107
HAJEK-KOFLER

Punches

REALSTAR SURGICAL INSTRUMENTS

130° upwards cutting

18-108
1 mm □

18-109
2 mm □

18-110
3 mm □

18-111
4 mm □

18-112
5 mm □

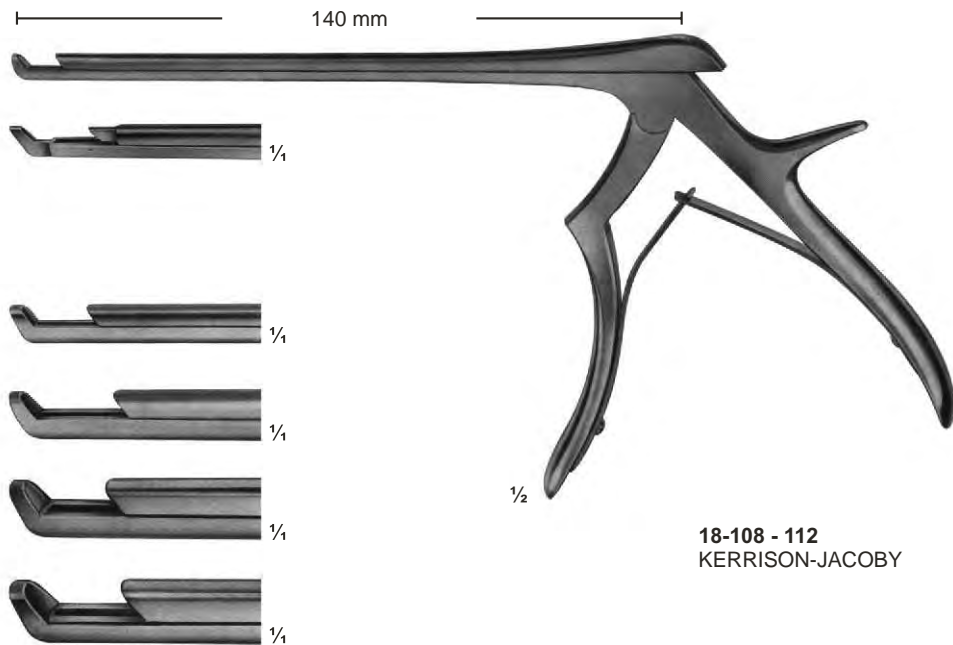

18-108 - 112
KERRISON-JACOBY

90° upwards cutting

18-113
1 mm □

18-114
2 mm □

FERRIS-SMITH-KERRISON

18-115
3 mm □

18-116
4 mm □

18-117
5 mm □

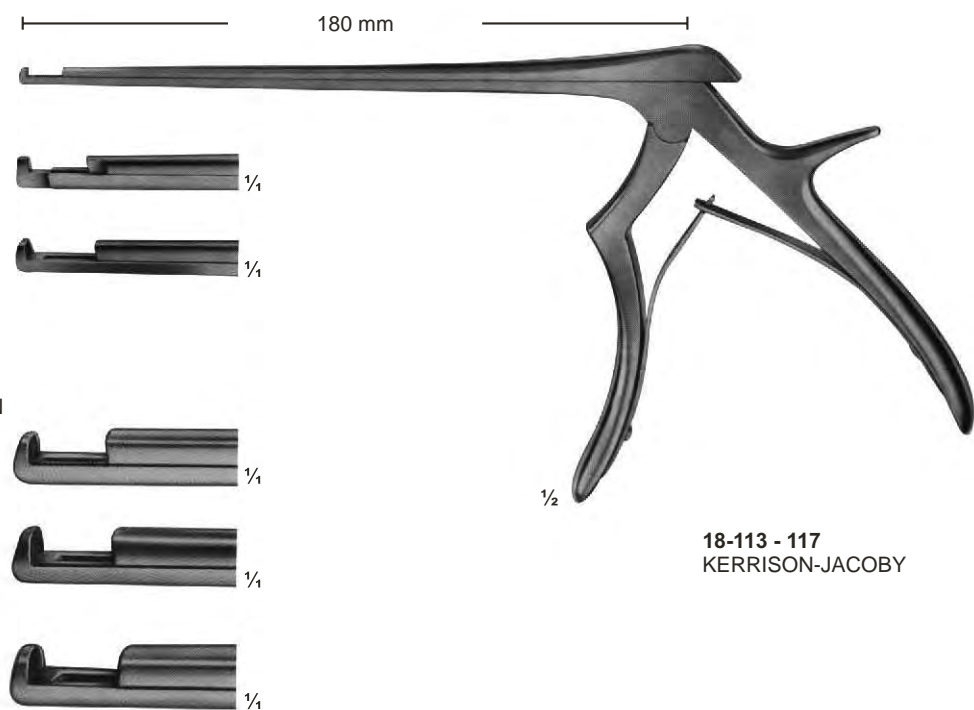

18-113 - 117
KERRISON-JACOBY

Angled positions for rongeurs

- 18-118**
3,0 mm
- 18-119**
3,6 mm
- 18-120**
4,2 mm
- 18-121**
4,8 mm
- 18-122**
5,8 mm

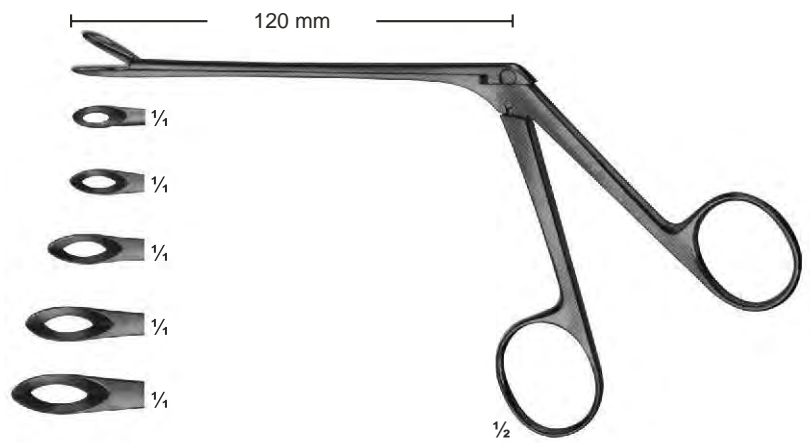

18-118 - 122
WEIL-BLAKESLEY

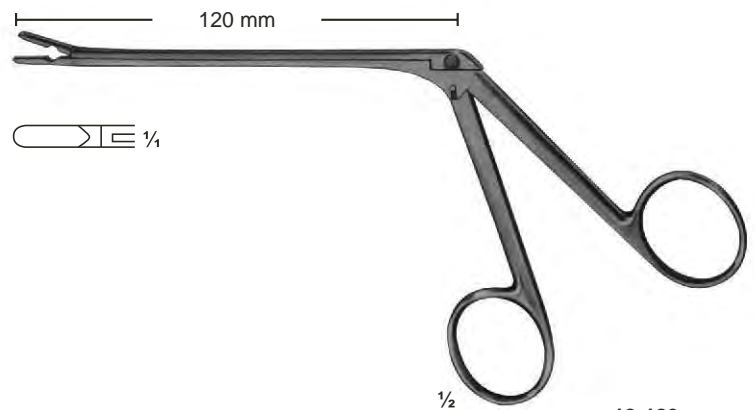

18-123
TAKAHASHI
3 mm

130°

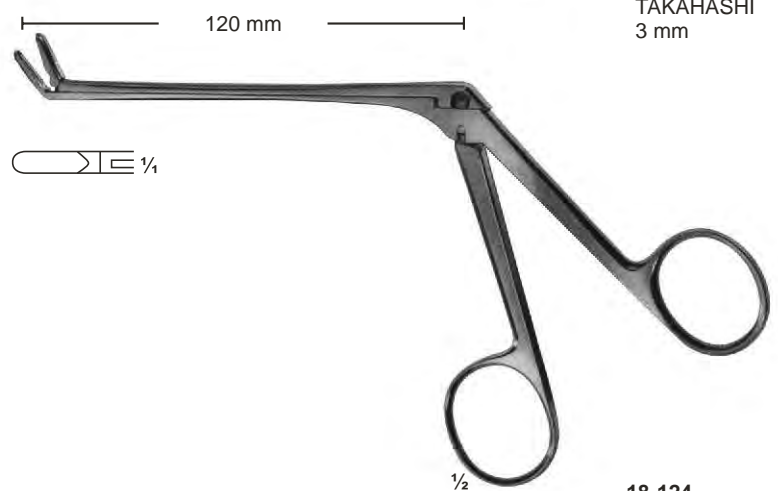

18-124
TAKAHASHI
3 mm

18-125
2 X 10 mm

18-126
3 X 10 mm

18-127
4 X 10 mm

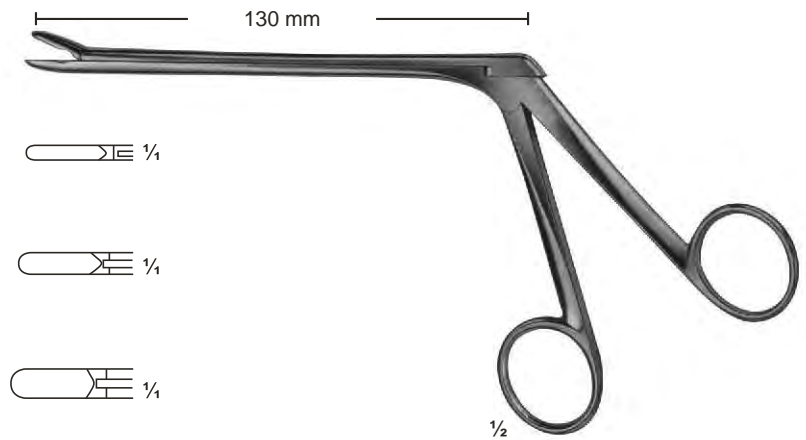

18-125 - 127
LOVE-GRUENWALD

18-128
2 mm

18-129
3 mm

18-130
4 mm

18-131
5 mm

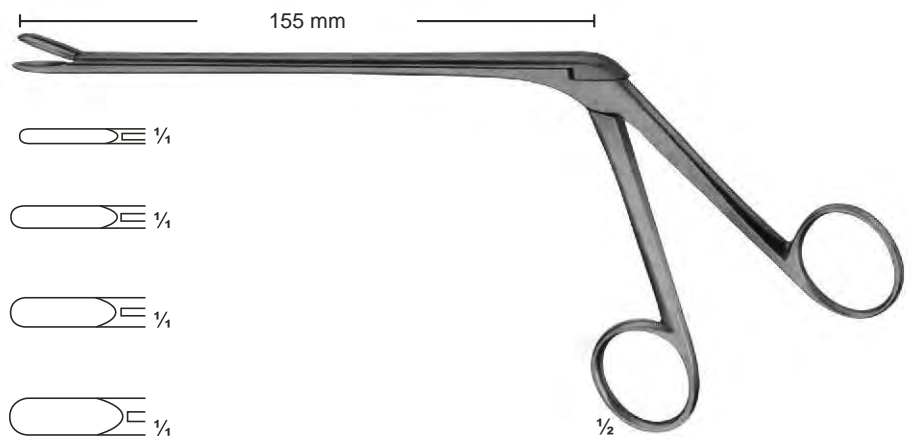

18-128 - 131
CASPAR

18-132
2 mm

18-133
3 mm

18-134
4 mm

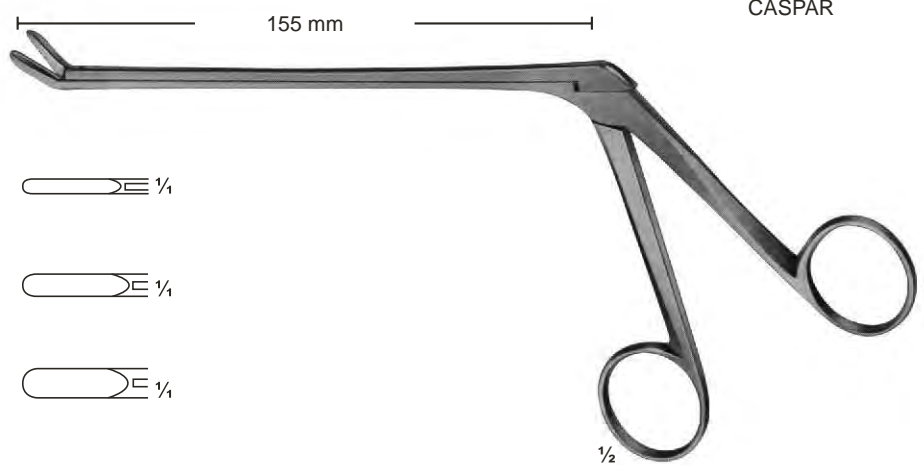

18-132 - 134
CASPAR

Rongeurs

REALSTAR SURGICAL INSTRUMENTS

155 mm

18-135
2 mm

18-136
3 mm

18-137
4 mm

1/2

18-135 - 137
CASPAR

Length of shaft 140 mm	Length of shaft 160 mm	Length of shaft 185 mm	size of jaws
18-138	18-143	18-148	2 X12 mm
18-139	18-144	18-149	3 X12 mm
18-140	18-145	18-150	4 X14 mm
18-141	18-146	18-151	5 X14 mm
18-142	18-147	18-152	6 X16 mm

1/2

18-138 - 152
CASPAR

Length of shaft 140 mm	Length of shaft 160 mm	Length of shaft 185 mm	size of jaws
18-153	18-156	18-159	3 X12 mm
18-154	18-157	18-160	4 X14 mm
18-155	18-158	18-161	5 X14 mm

1/2

18-153 - 161
CASPAR

Rongeurs

REALSTAR SURGICAL INSTRUMENTS

Length of shaft 140 mm	Length of shaft 160 mm	Length of shaft 185 mm	size of jaws
18-162	18-164	185-166	3 X12 mm
18-163	18-165	18-167	4 X14 mm

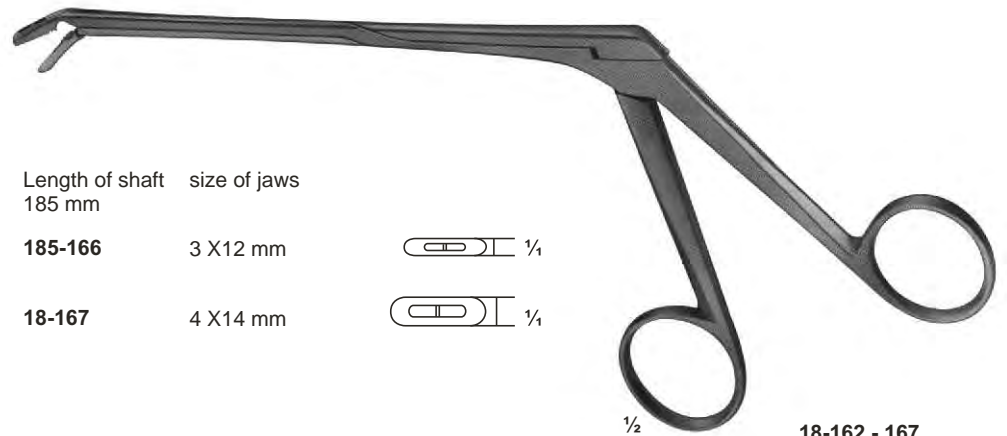
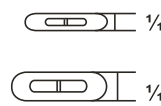

18-162 - 167
GUSHING

18-168
2 X 10 mm
GUSHING



18-169
3 X 10 mm
LOVE-GRUENWALD

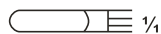

18-170
4 X 10 mm
SPURLING

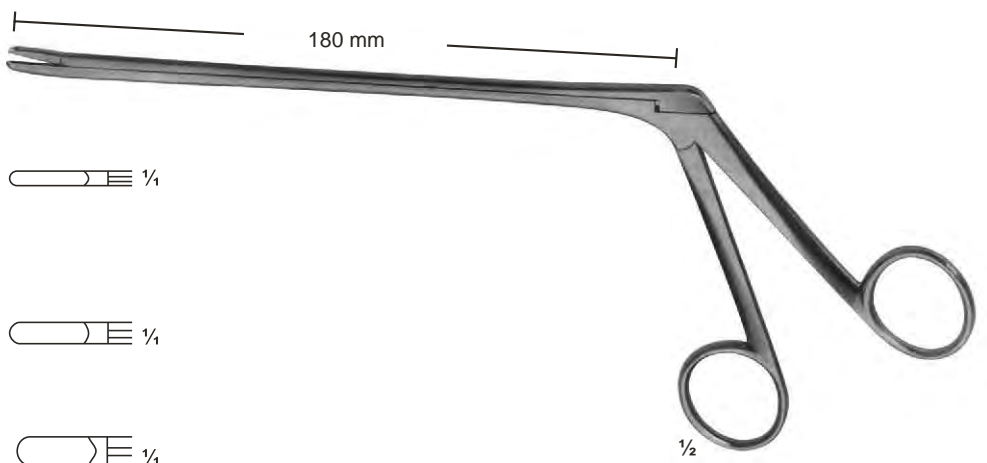
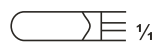

18-168 - 170
LOVE-GRUENWALD

18-171
3 X 10 mm
LOVE-GRUENWALD



18-172
4 X 10 mm
SPURLING

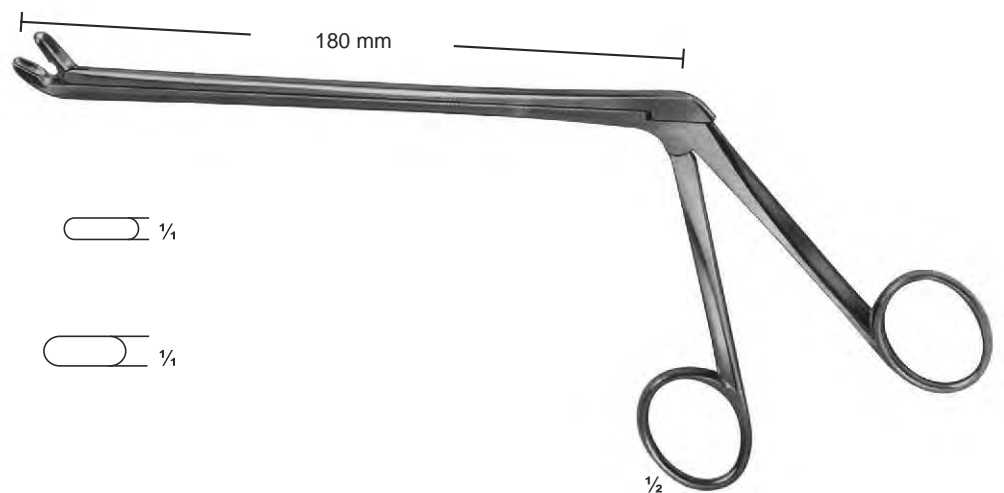

18-171 - 172
LOVE-GRUENWALD

18-173
3 X 10 mm
LOVE-GRUENWALD

18-174
4 X 10 mm
SPURLING

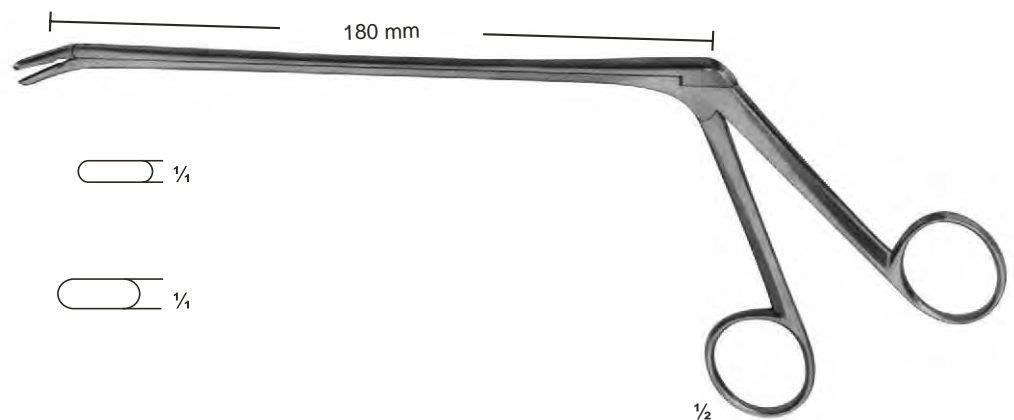

18-173 - 174
LOVE-GRUENWALD

18-175
7 mm

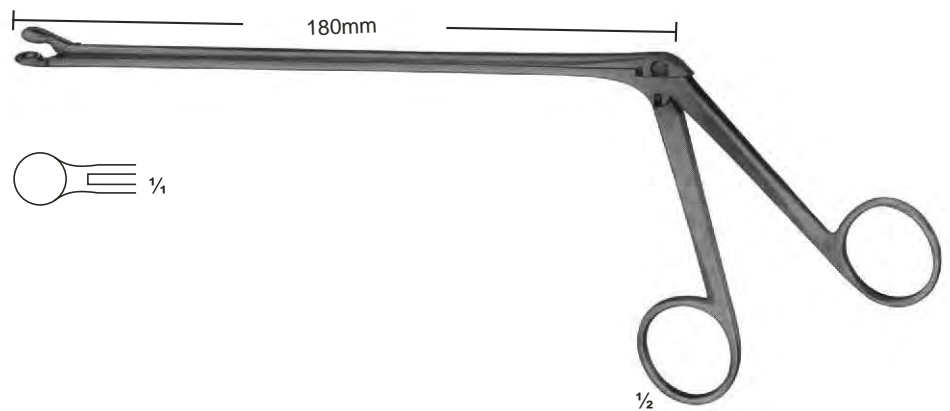

18-175
OLDBERG

18-176
YASARGIL
2,2 mm

18-177
YASARGIL
3,5 mm

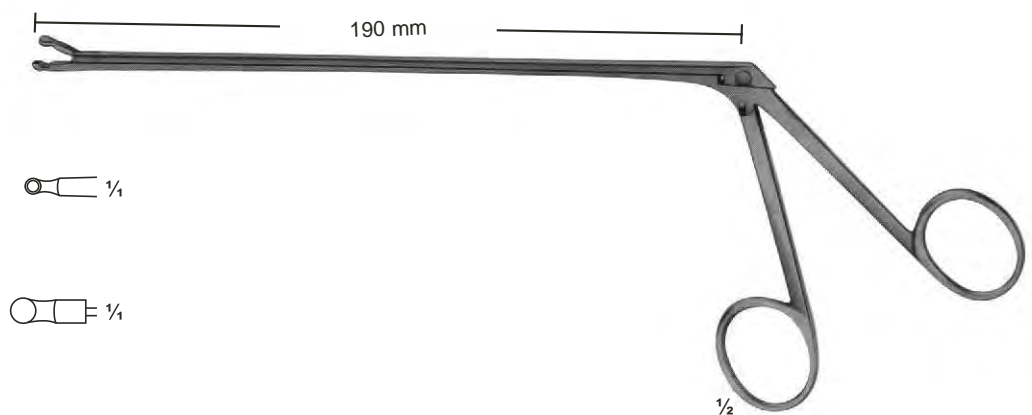

18-176 - 177

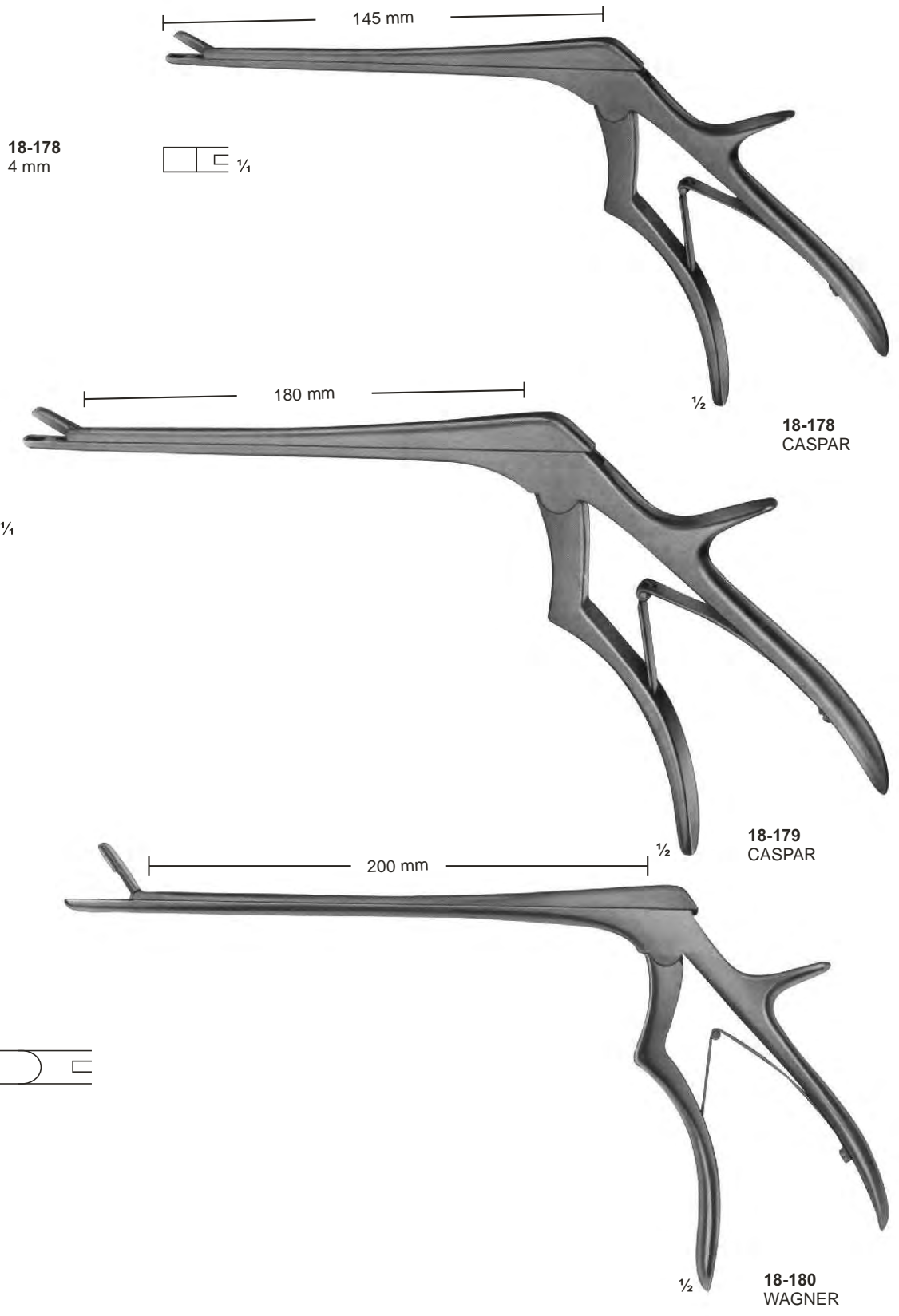



19-101
Comprimeter. Compression apparatus for producing exsanguination in the extremities. Manometer registers up to 600 mm Hg. Complete, consisting of :
19-101 2 Pump with manometer
19-102 3 Cuff for the leg
19-103 14 Cuff for the upper arm



19-104 3 Cuff for the leg
19-105 4 Cuff for the lower arm
19-106 5 Cuff for children
19-107 14 Cuff for the upper arm

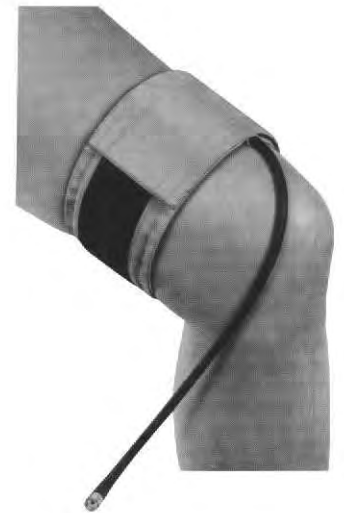

19-108
ESMARCH
Staubinde
Compression bandage
5 m lang/long
6 cm breit/wide



19-109
ESMARCH
Stauschlauch
Compression tube
1 m lang/long

Amputation and Resection Knives

REALSTAR SURGICAL INSTRUMENTS



19-110
Length of blades
Phalangeal knife
105 mm



19-111
Length of blades
Interosseous knife
110 mm



19-112
Length of blades
Periosteum knife
with raspatory
65 mm



19-113 - 114
LANGENBECK
Length of blades
Resection knives
55 mm



19-113

19-114

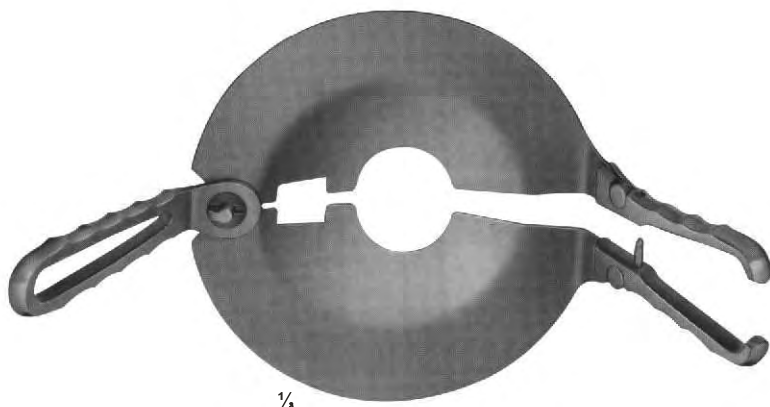

¼

19-115
PERCY
removeable handles

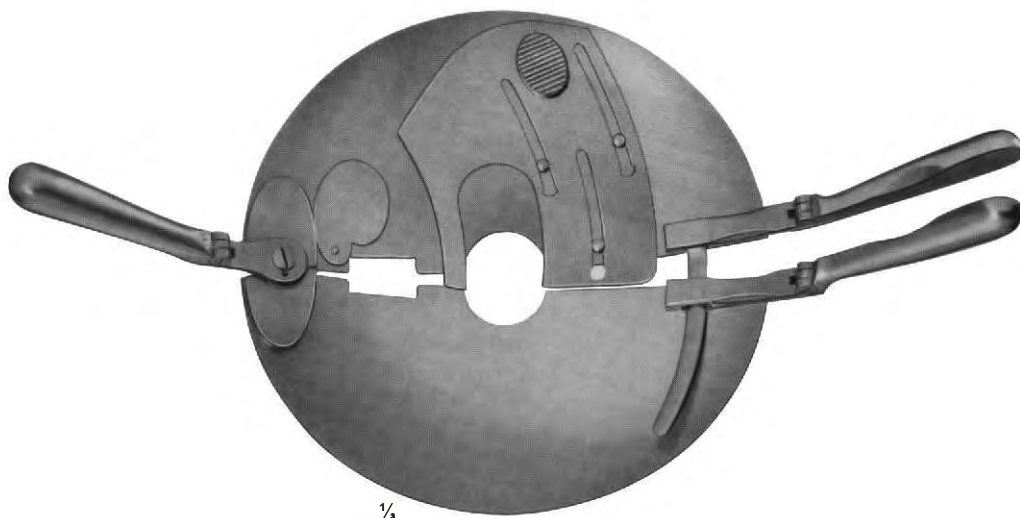

¼

19-116
PERCY
reversible handles

Amputation Saws

REALSTAR SURGICAL INSTRUMENTS



$\frac{1}{4}$
19-117
CHARRIEER
Length of blade
215 mm
complete with one saw
blade each
350 mm
Spare saw blades, carbon steel
19-118 12 mm
19-119 20 mm



$\frac{1}{4}$
19-120
RUST
Length of blade
235 mm
complete with one saw
blade each
390 mm
19-121 Bow only
Spare saw blades, carbon steel
19-122 6 mm
19-123 8 mm
19-124 12 mm
19-125 20 mm

Amputation Saws

REALSTAR SURGICAL INSTRUMENTS

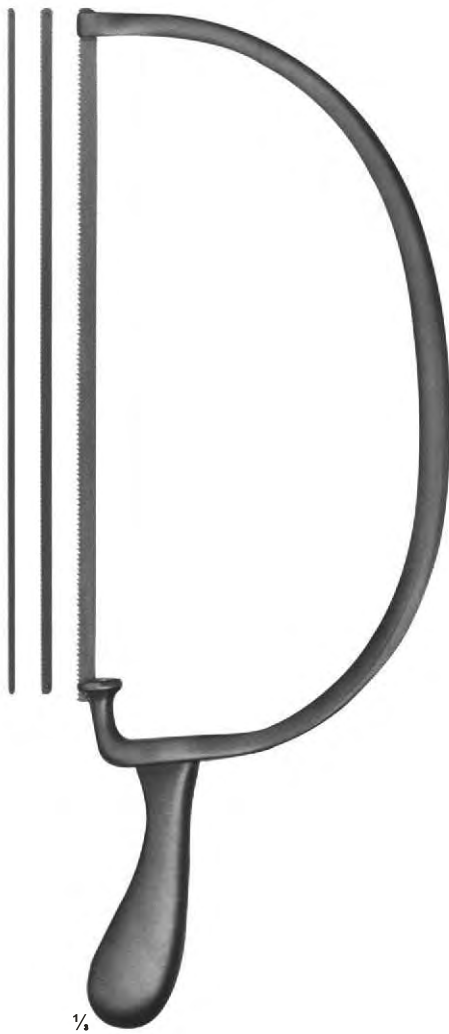

1/4

19-126
BIER
Length of blade
270 mm
complete with one saw
blade each
420 mm
Spare saw blades, carbon steel
19-127 4 mm
19-128 6 mm
19-129 8 mm



1/4

19-130
CHARRIERE
Length of blade
180 mm
Spare saw blades,
carbon steel
270 mm

19-131
CHARRIERE
Length of blade
240 mm
Spare saw blades,
carbon steel
340 mm



1/4

19-132
SATTERLEE
Length of blade
200 mm
Spare saw blades,
carbon steel
290 mm



1/4

19-133
LANGENBACK
Length of blade
115 mm
Metacarpal saw
235 mm



OLIVECRONA
19-134 300 mm
19-135 400 mm
19-136 500 mm
19-137 700 mm

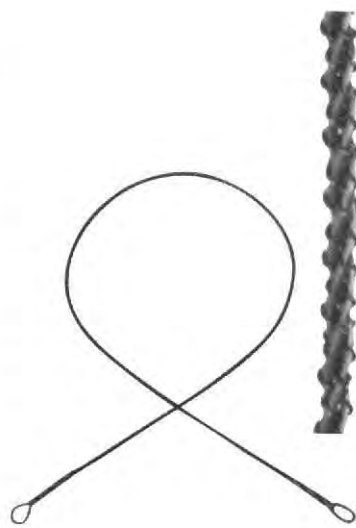

GIGLI
19-138 300 mm
19-139 400 mm
19-140 500 mm
fine, 6 wires twisted
19-141
coarses, 4 wires twisted



$\frac{1}{4}$
19-142
GIGLI
Handle



$\frac{1}{2}$
19-143
LEBSCHE
Conductor for
wire saws, malleable
250 mm

Elevators and Bone Levers

REALSTAR SURGICAL INSTRUMENTS

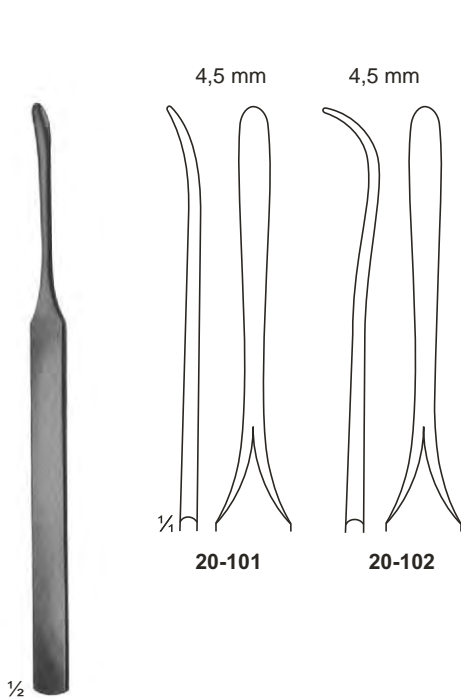

20-101 - 102
KONIG
155 mm

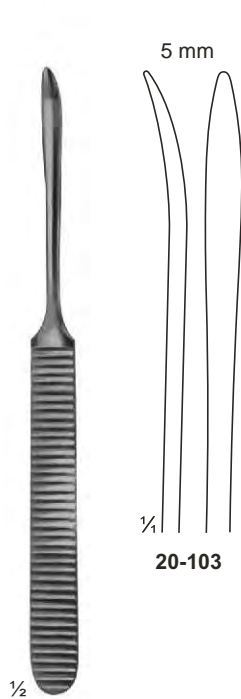

20-103
WILLIGER
165 mm

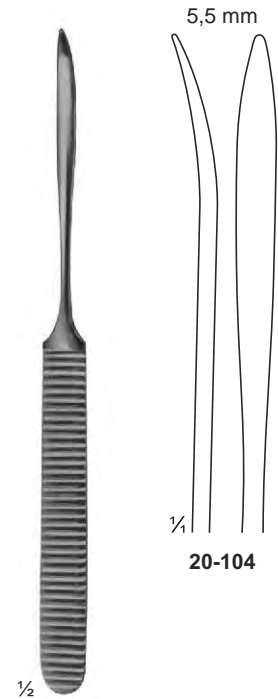

20-104
WILLIGER
170 mm

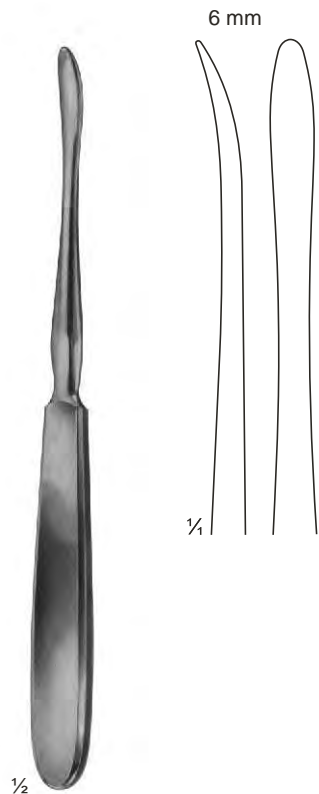

20-105
QUERVAIN
195 mm

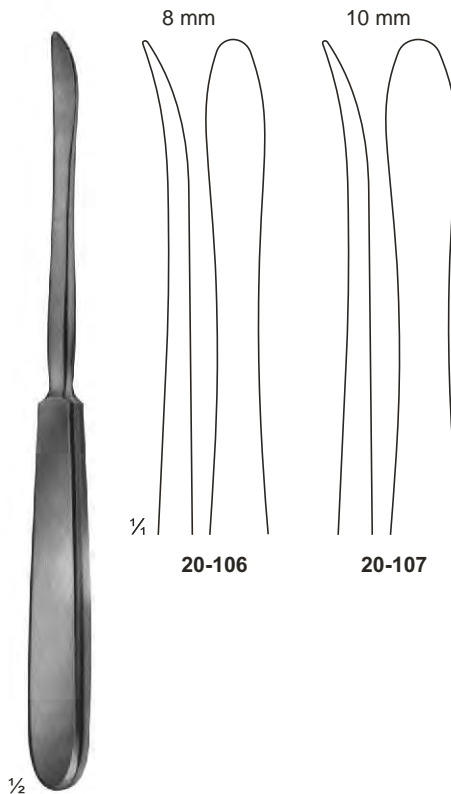

20-106 - 107
LANGENBACK
195 mm

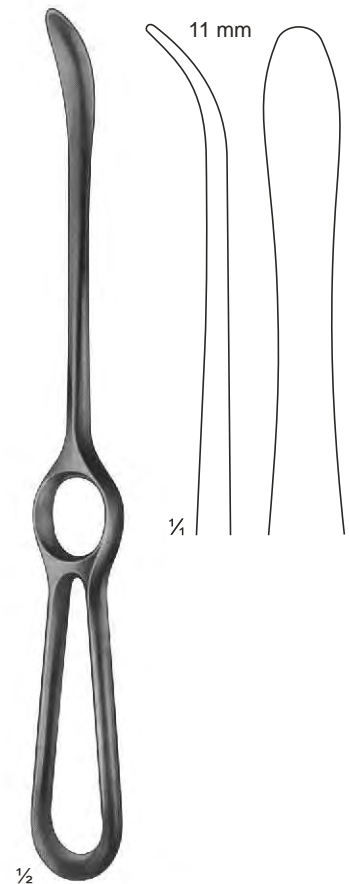

20-108
LANGENBACK
230mm

Bone Levers

REALSTAR SURGICAL INSTRUMENTS

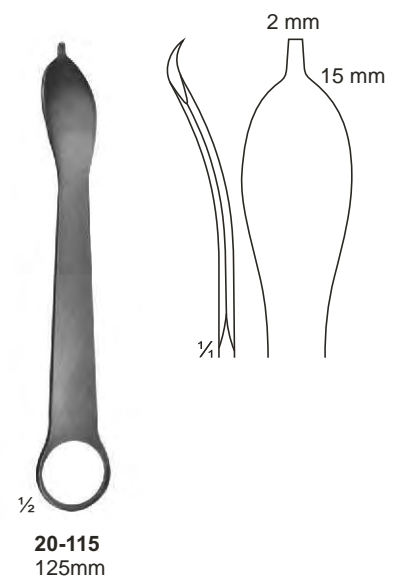
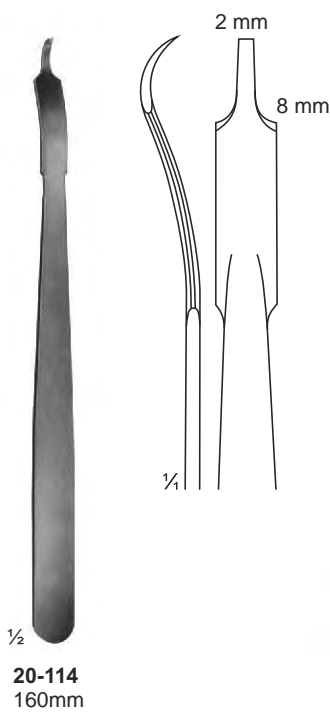
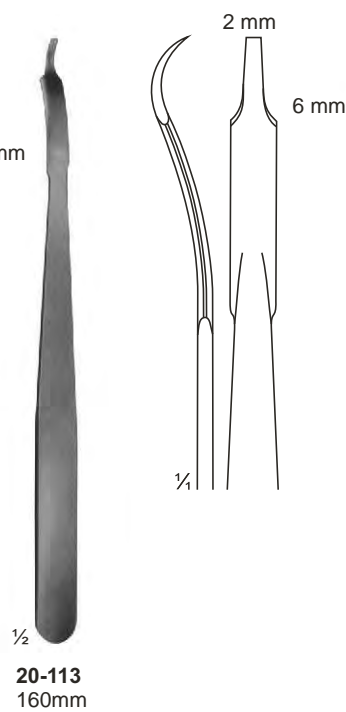
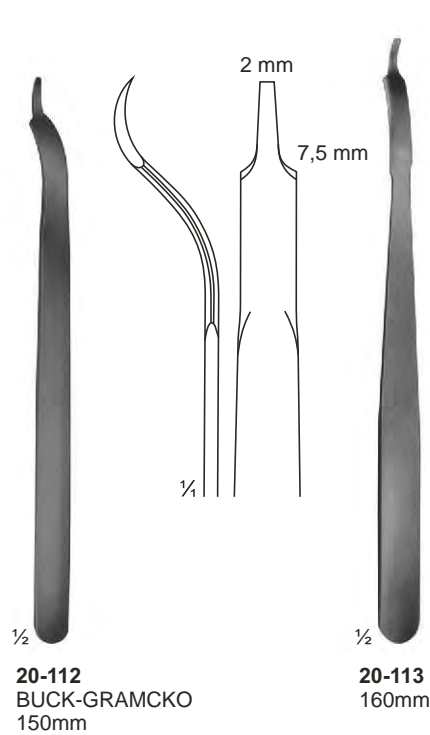
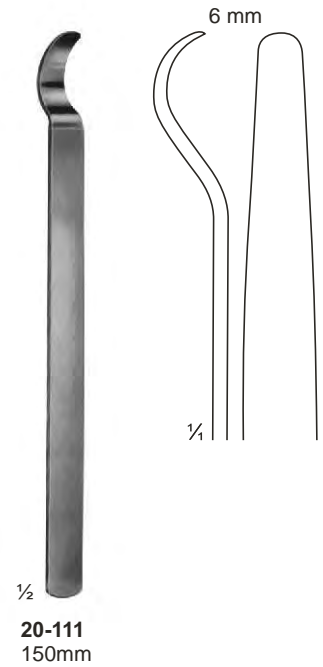
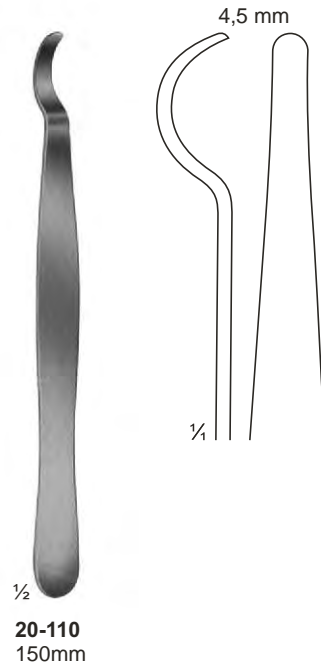
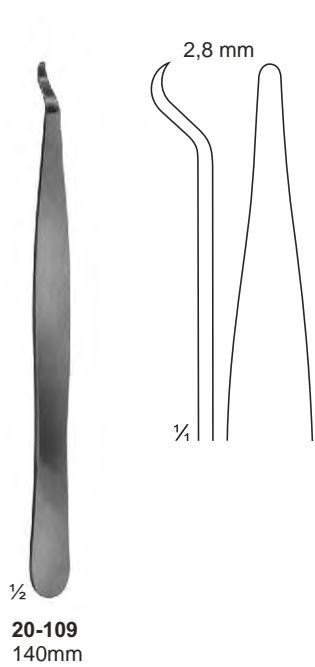

Bone Levers

REALSTAR SURGICAL INSTRUMENTS



20-116
LANE TRETOWAN
215mm

20-117
LANE
255mm

20-118
LANGE-HOHMANN
250mm

20-119 - 120
LANGE-HOHMANN
20-119 265mm
20-120 280mm

Bone Levers

REALSTAR SURGICAL INSTRUMENTS

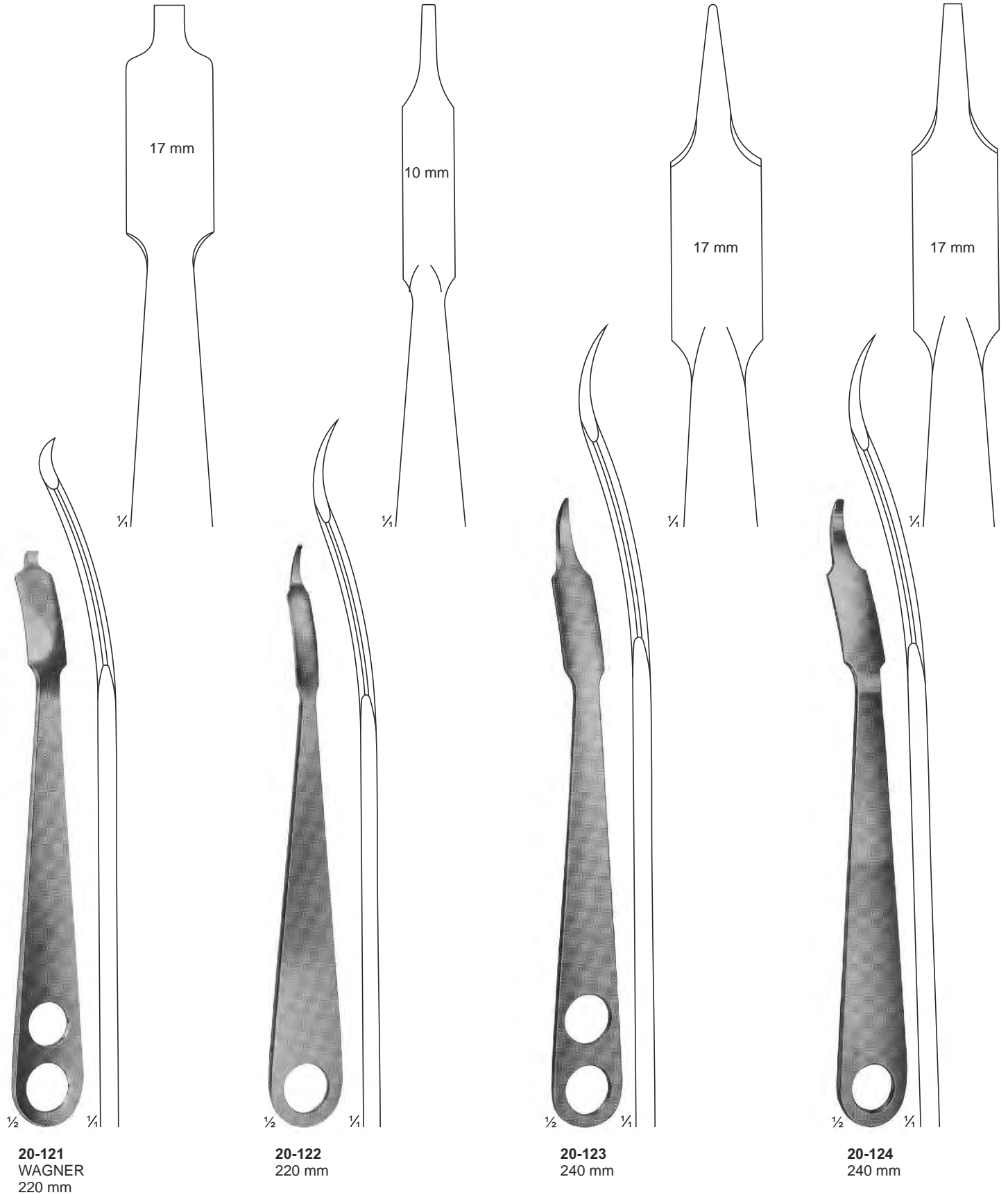

20-121
WAGNER
220 mm

20-122
220 mm

20-123
240 mm

20-124
240 mm

Bone Levers

REALSTAR SURGICAL INSTRUMENTS

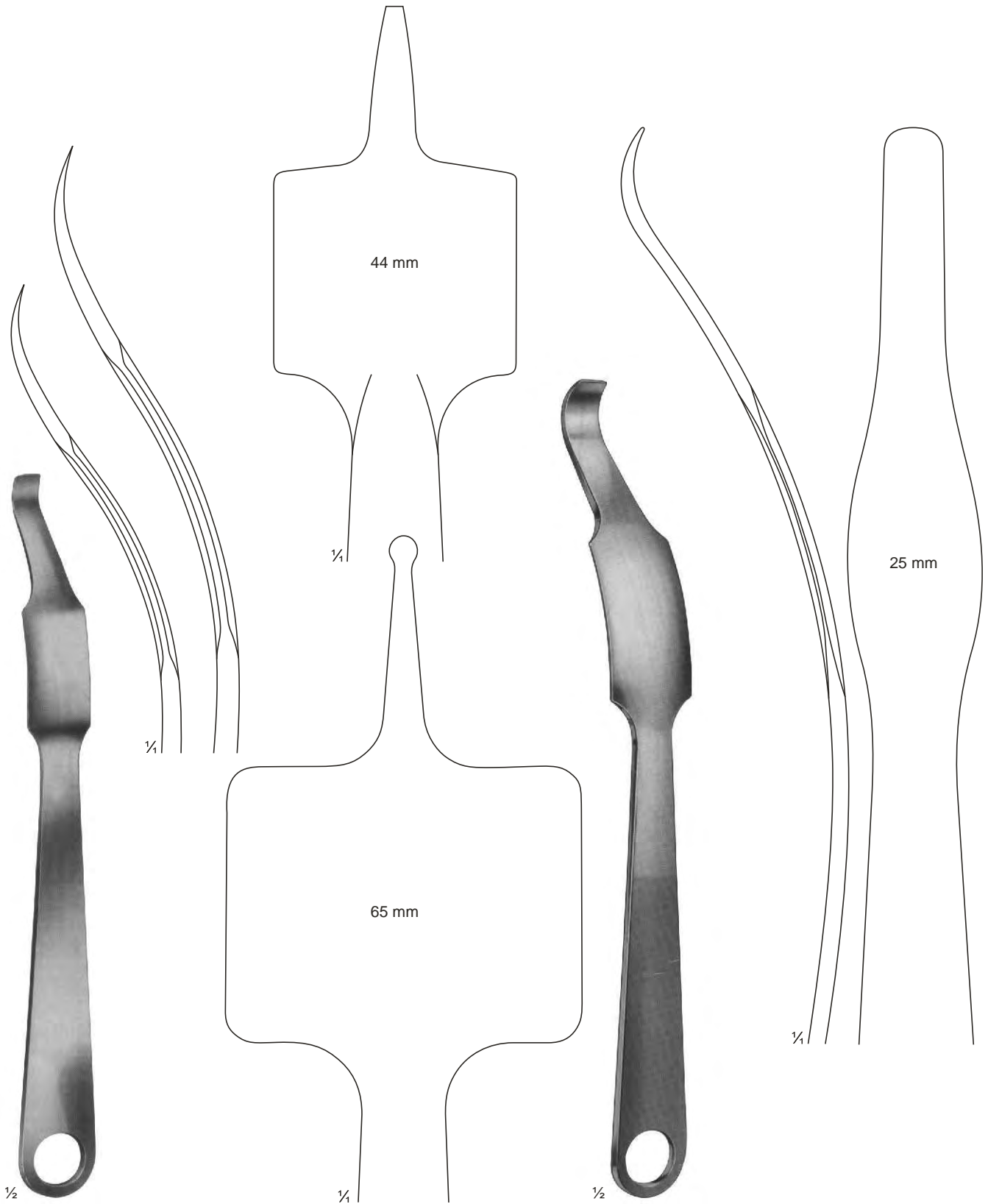

20-125 - 126
 VERBRUGGE-MULLER
 20-125 240 mm
 20-126 255 mm

20-127
 260 mm

Bone Levers

REALSTAR SURGICAL INSTRUMENTS

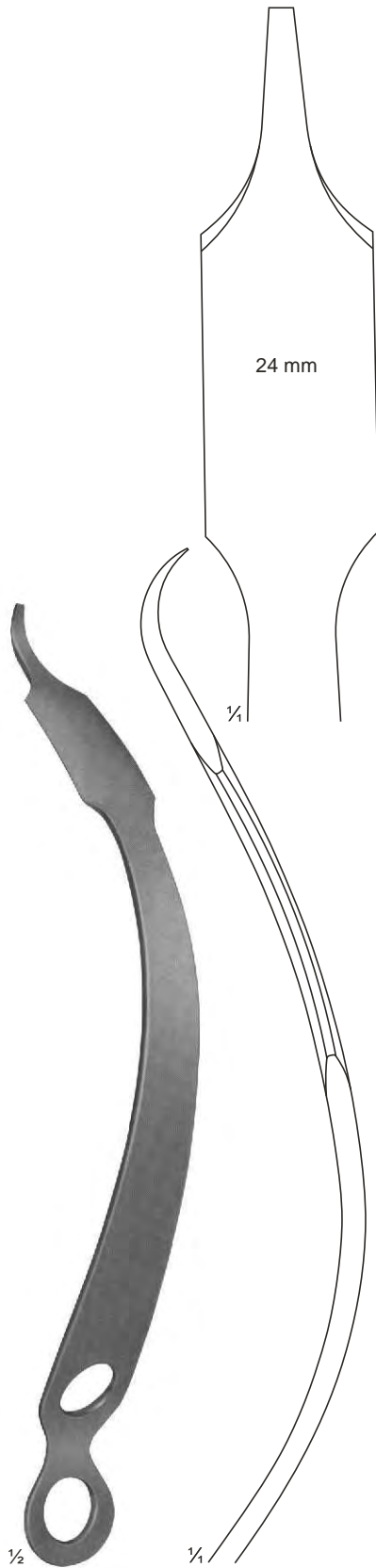

20-128
HOHMANN-ALDINGER
270 mm

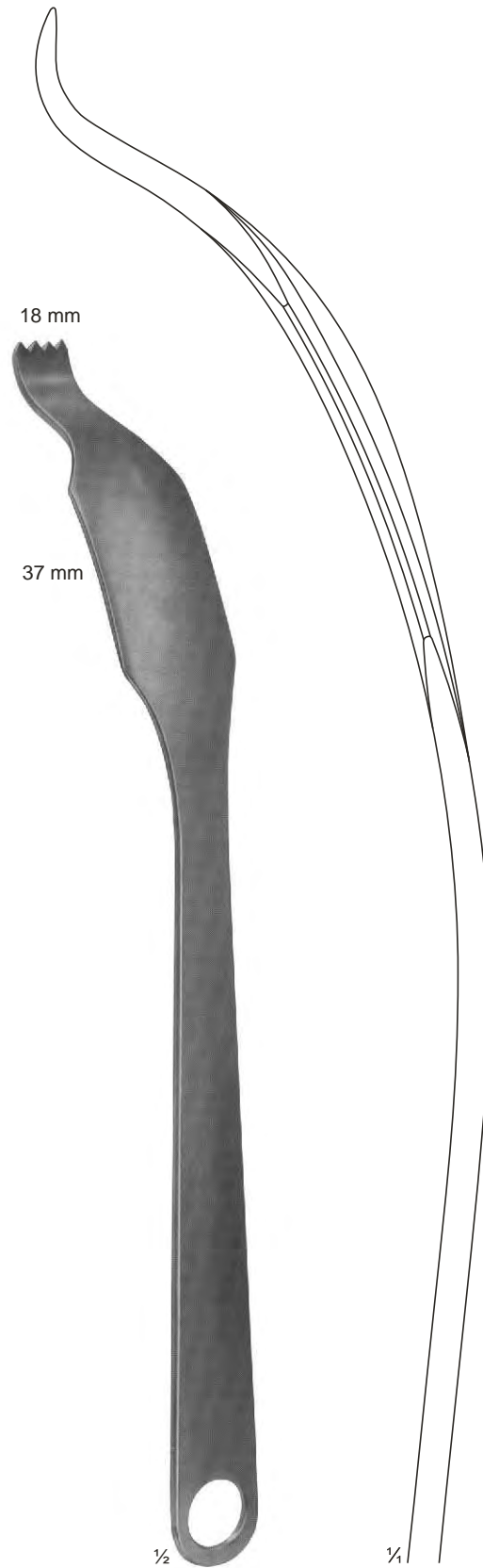

20-129
SCHUMACHER mod. WAGNER
345 mm

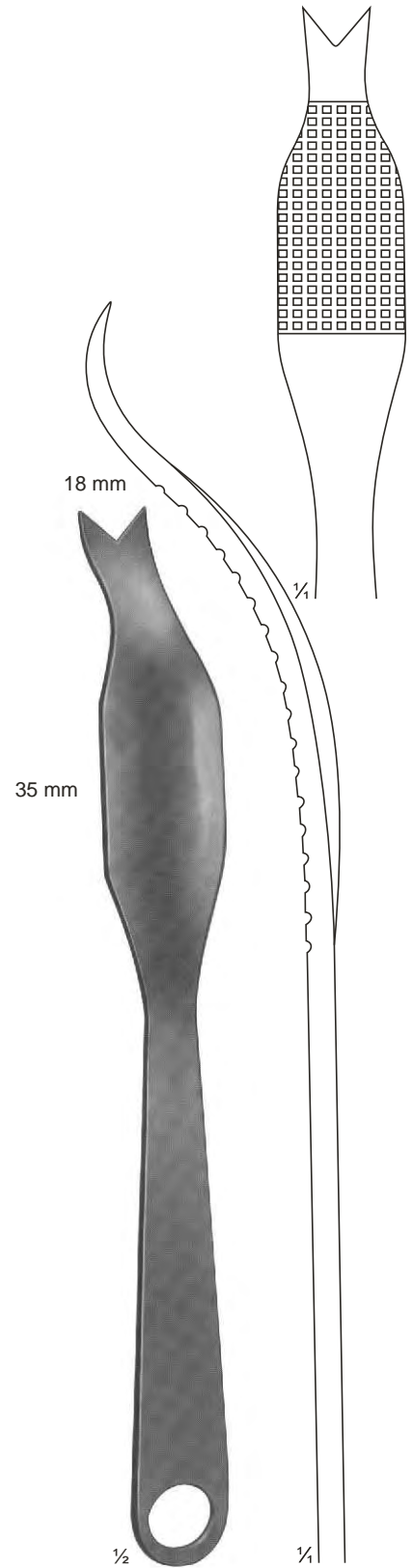

20-130
SCHUMACHER
290 mm

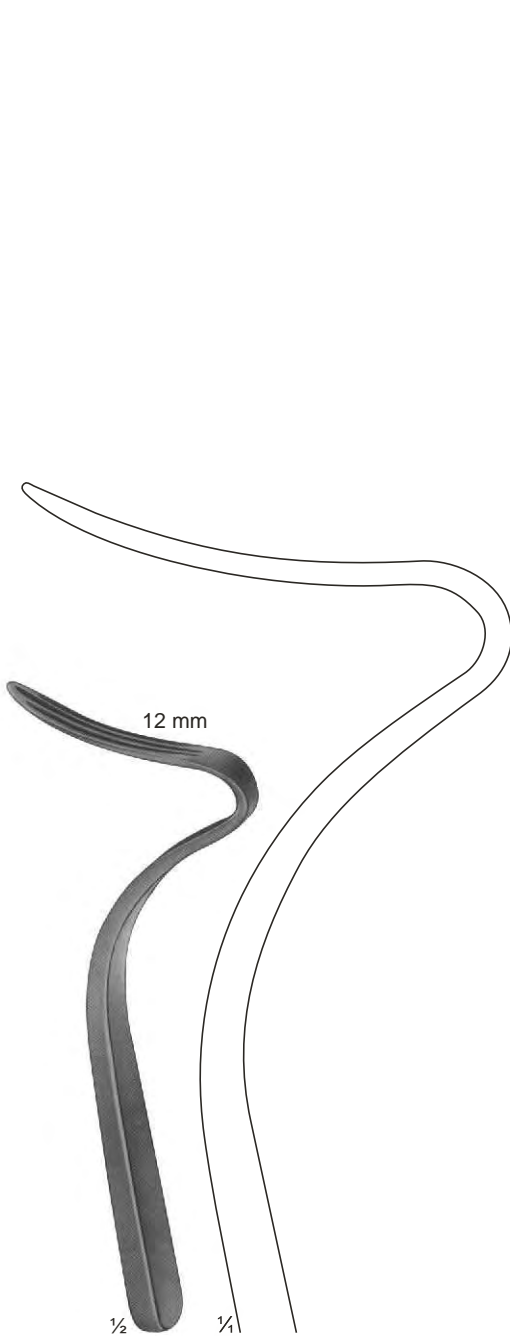

20-131
TAGER
Bone lever for
angle joint operations
175 mm



20-132
BENNETT
235 mm

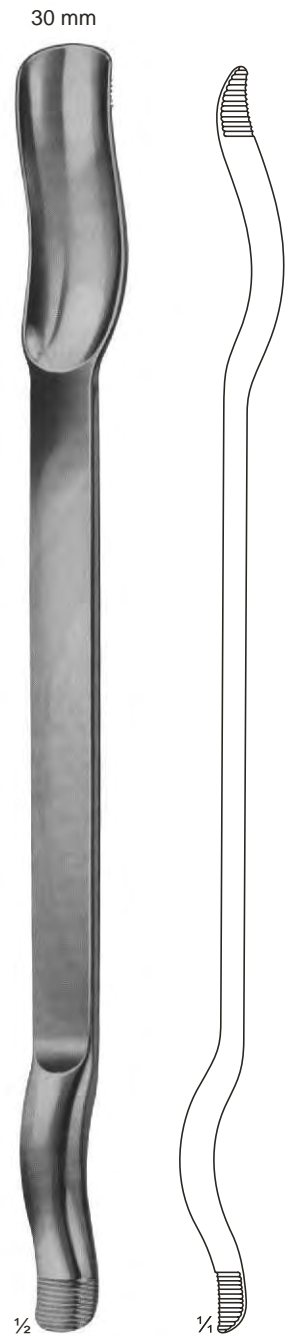

20-133
MURPHY-LANE
Luxation lever
340 mm

Raspatories

REALSTAR SURGICAL INSTRUMENTS

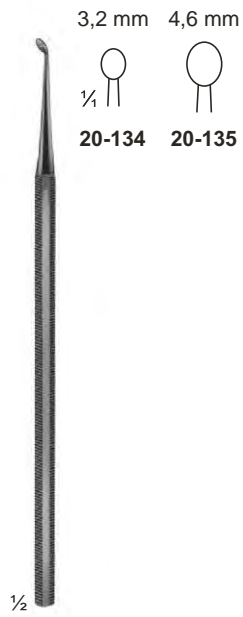

20-134 - 135
PARTSCH
150 mm

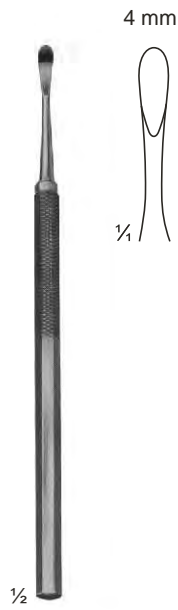

20-136
PARTSCH mod. LANGE
145 mm



20-137
MC KENTY
155 mm

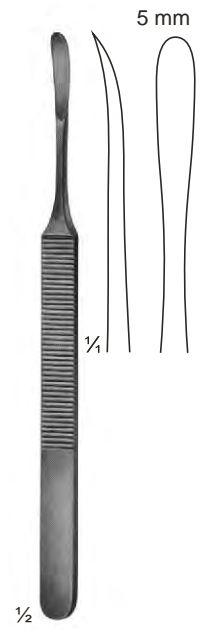

20-138
KONIG
155 mm

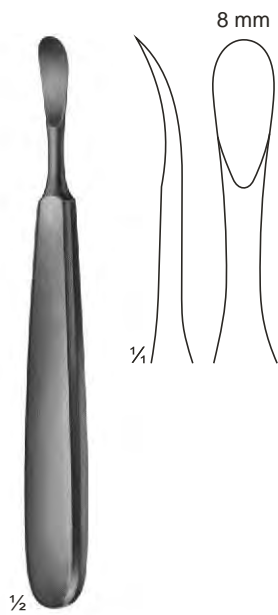

20-139
TRELAT
150 mm

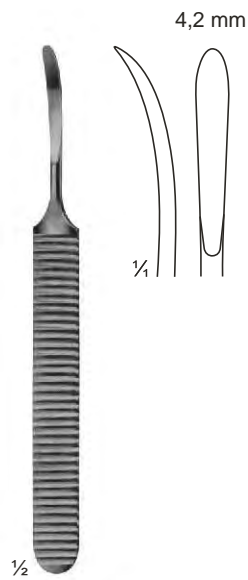

20-140
WILLIGER
140 mm

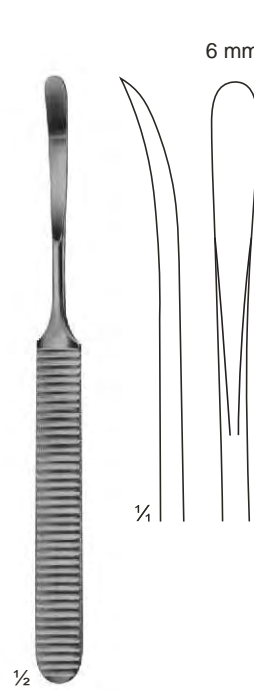

20-141
WILLIGER
160 mm

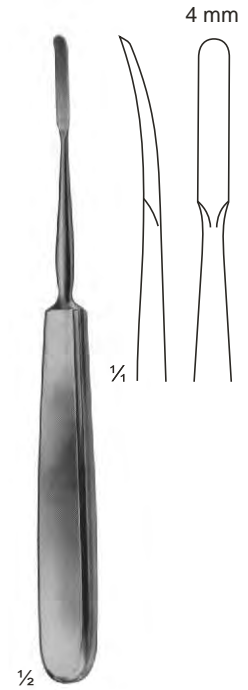

20-142
JOSEPH
170 mm

Raspatories

REALSTAR SURGICAL INSTRUMENTS

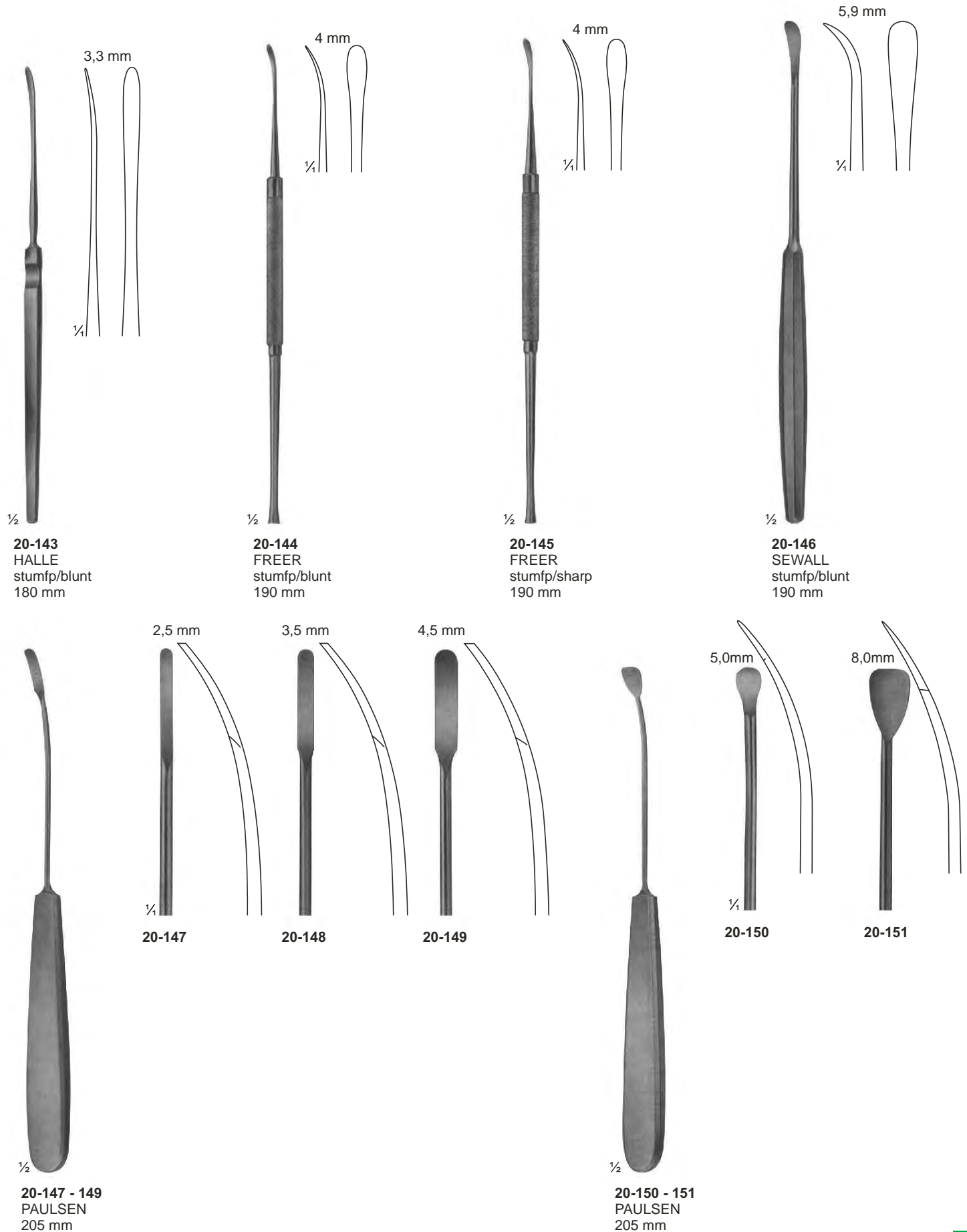

Raspatories

REALSTAR SURGICAL INSTRUMENTS

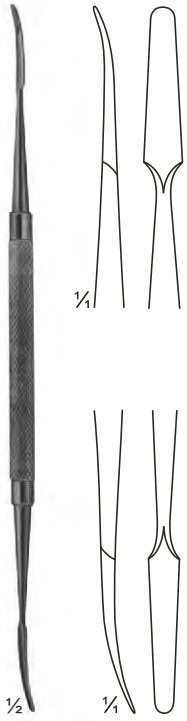

20-152
KILLIAN
sharp/blunt
185 mm

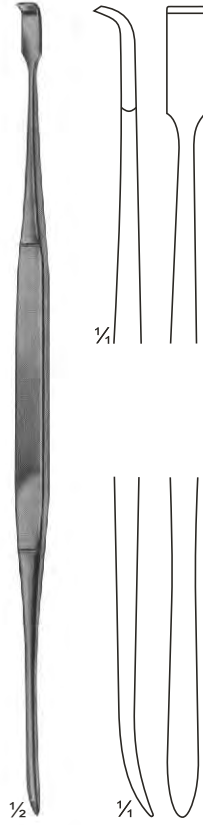

20-153
HOWARTH
sharp/blunt
215 mm

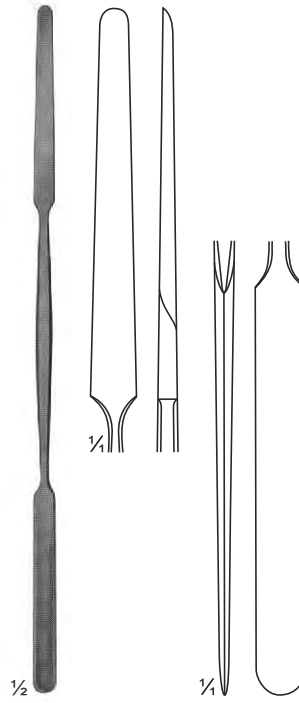

20-154
KILLIAN
sharp/blunt
185 mm

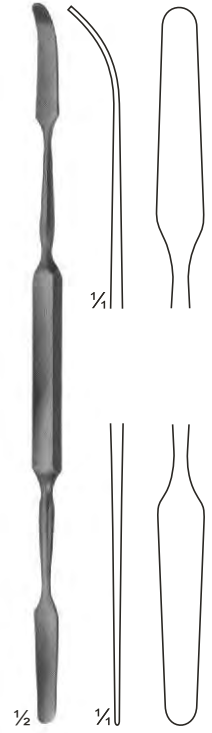

20-155
MAC DONALD
blunt/blunt
185 mm

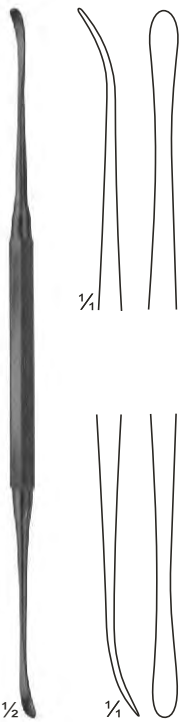

20-156
FREER
sharp/blunt
185 mm

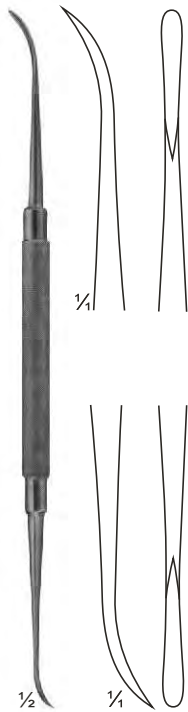

20-157
FREER-YASARGIL
sharp/sharp
185 mm

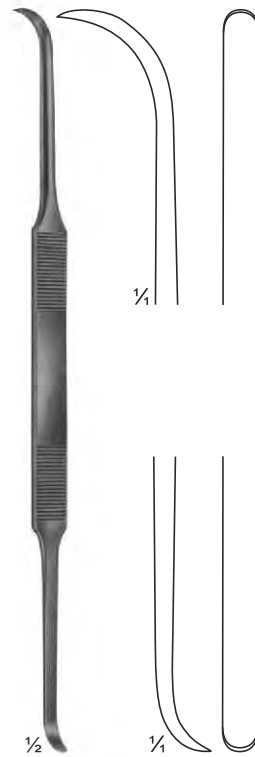

20-158
COTTLE
sharp/sharp
200 mm

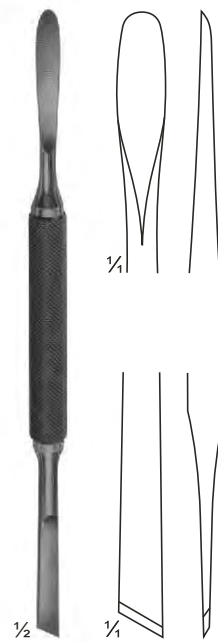

20-159
MEAD
sharp/sharp
165 mm

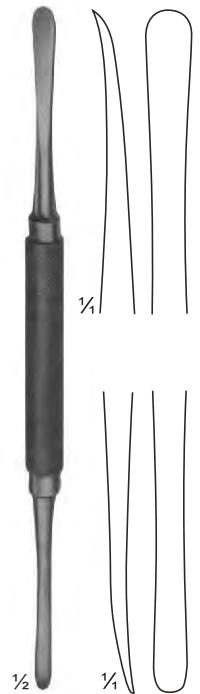

20-160
MOLT
sharp/sharp
180 mm

Raspatories

REALSTAR SURGICAL INSTRUMENTS

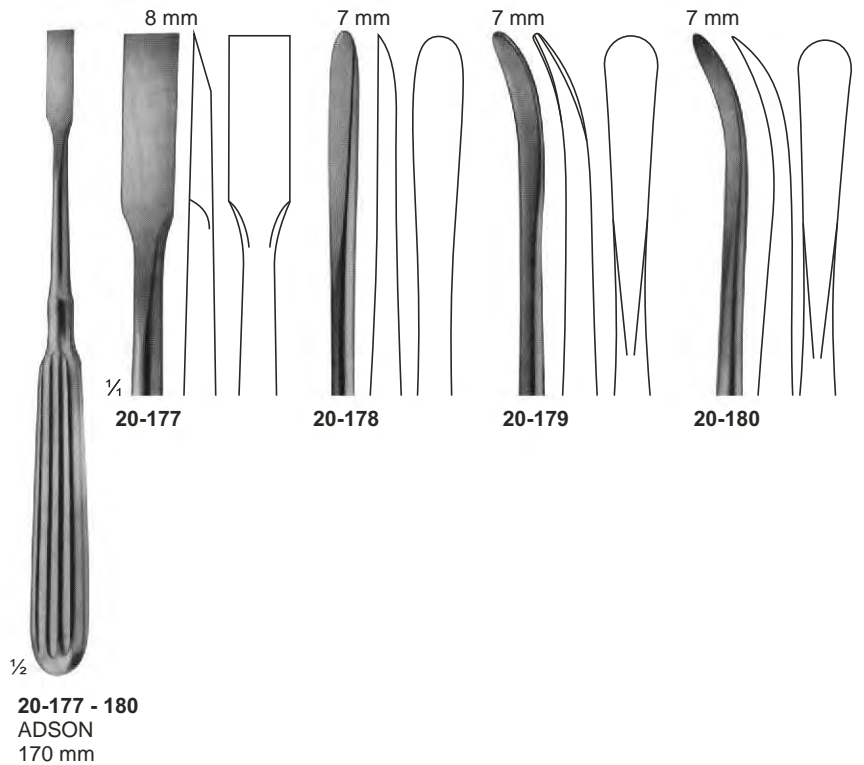
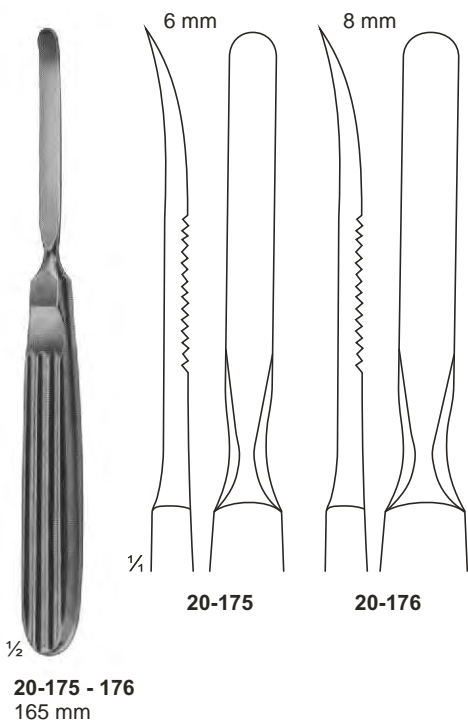
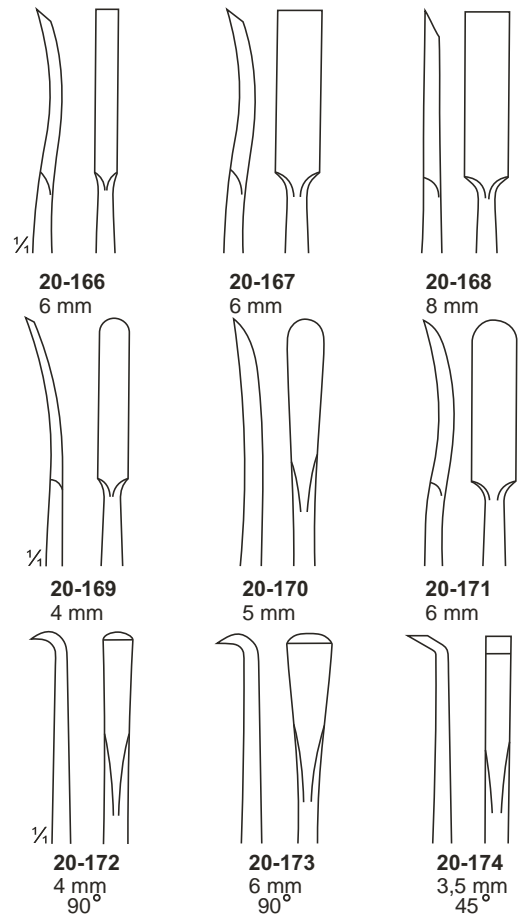
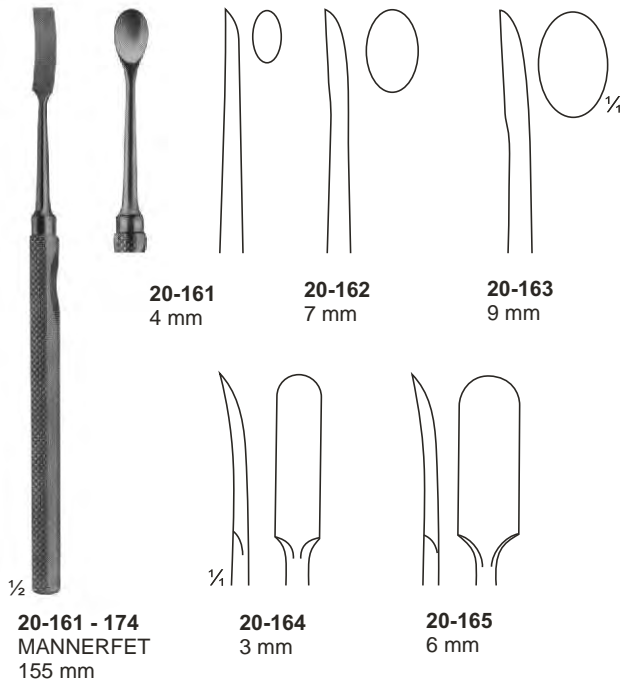

Raspatories

REALSTAR SURGICAL INSTRUMENTS

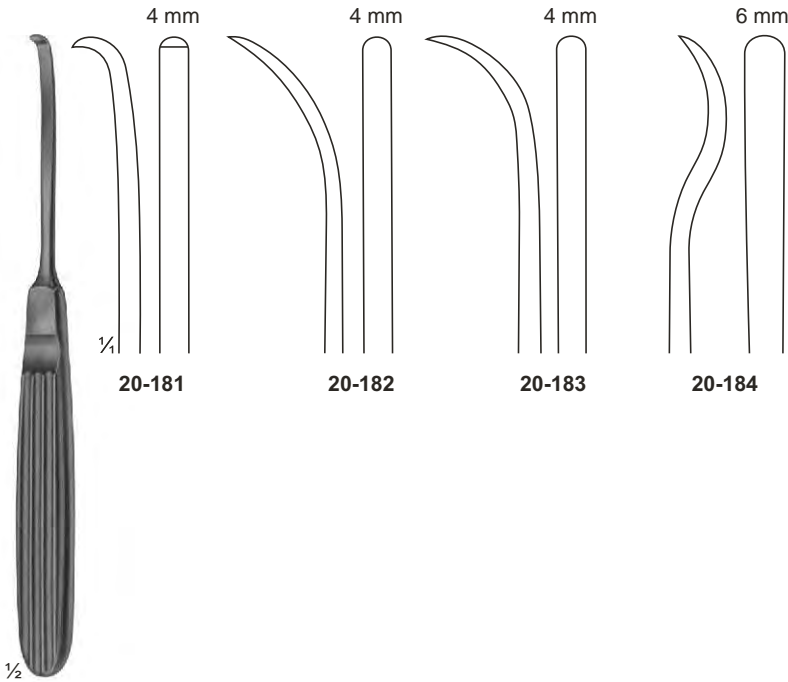

20-181 - 184
MUHLING
 170 mm

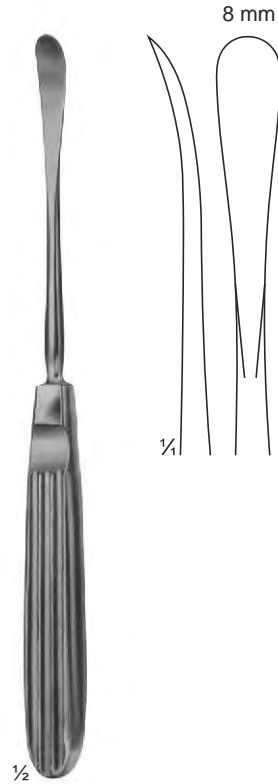

20-185
COTTLE
 175 mm

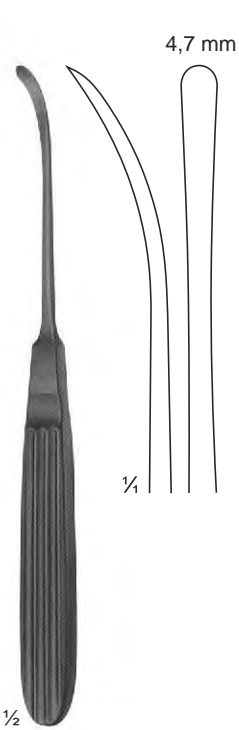

20-186
LANDOT
 175 mm

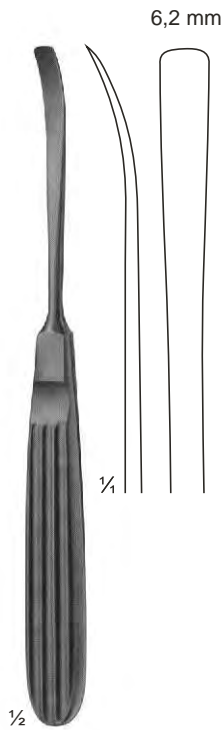

20-187
CASPER
 180 mm

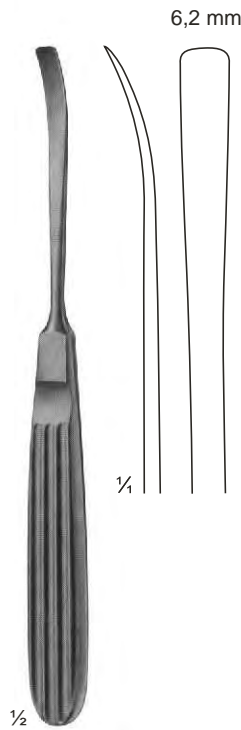

20-188
CASPER
 180 mm

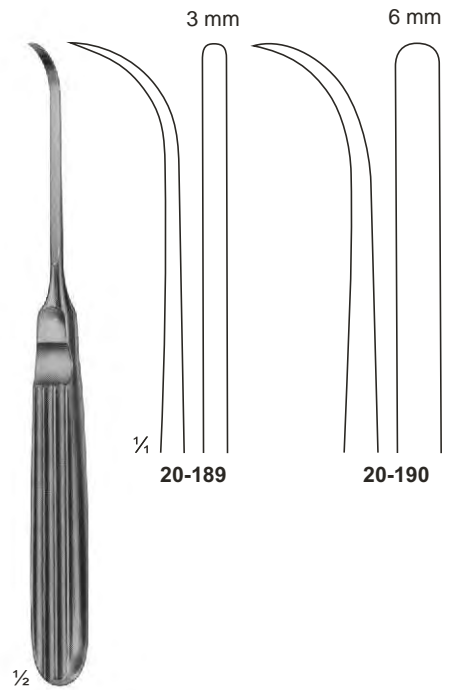

20-189 - 190
 170 mm

Raspatories

REALSTAR SURGICAL INSTRUMENTS

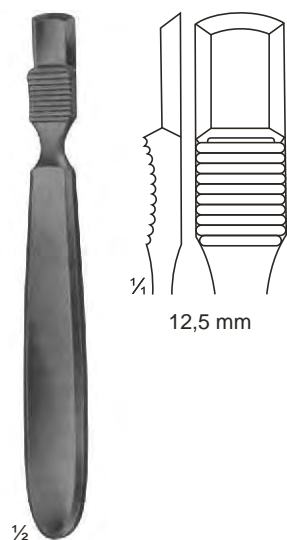

20-191
FARABEU
140 mm

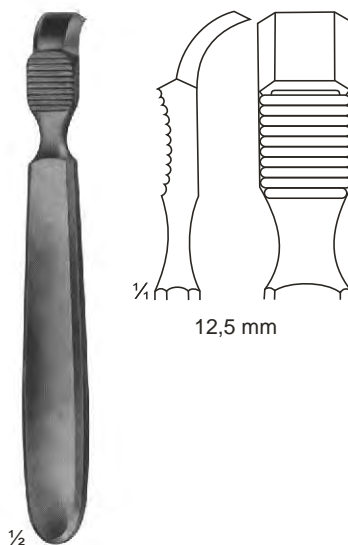

20-192
FARABEU
140 mm

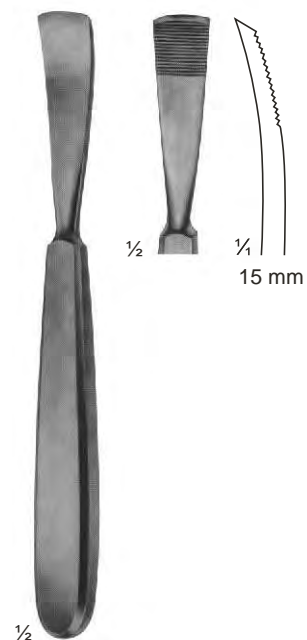

20-193
JANSEN
165 mm

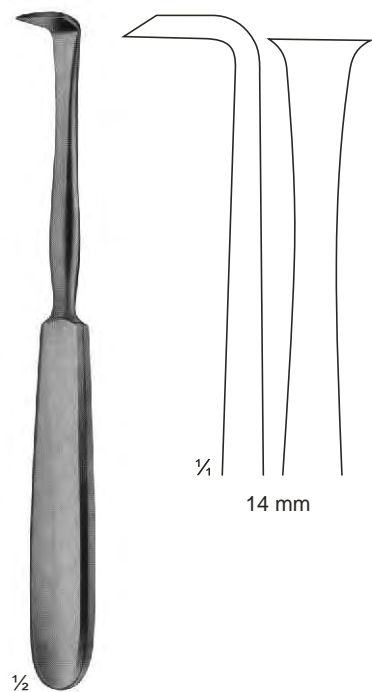

20-194
LANGENBACK
180 mm

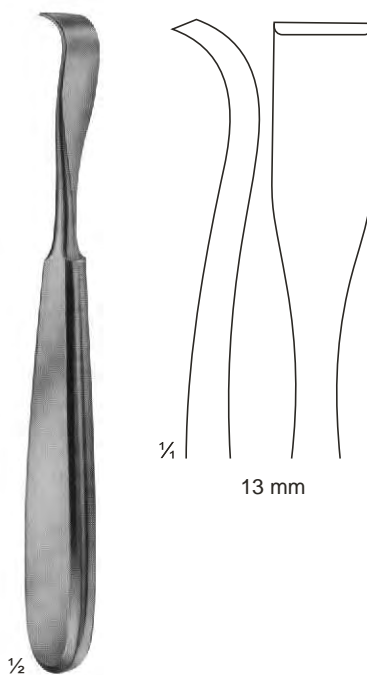

20-195
SCHNEIDER
175 mm

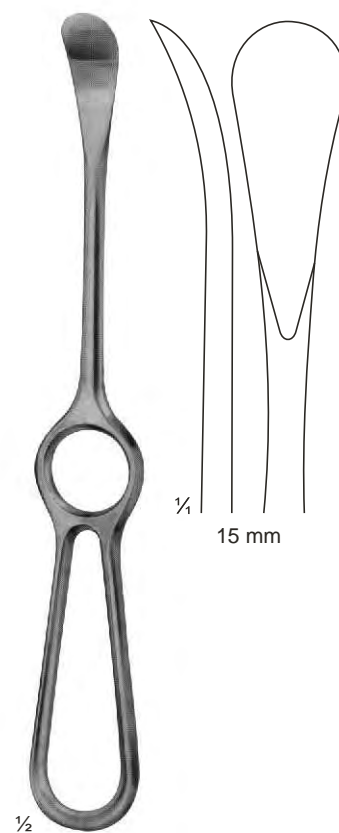

20-196
SEDILLOT
215 mm

Raspatories

REALSTAR SURGICAL INSTRUMENTS

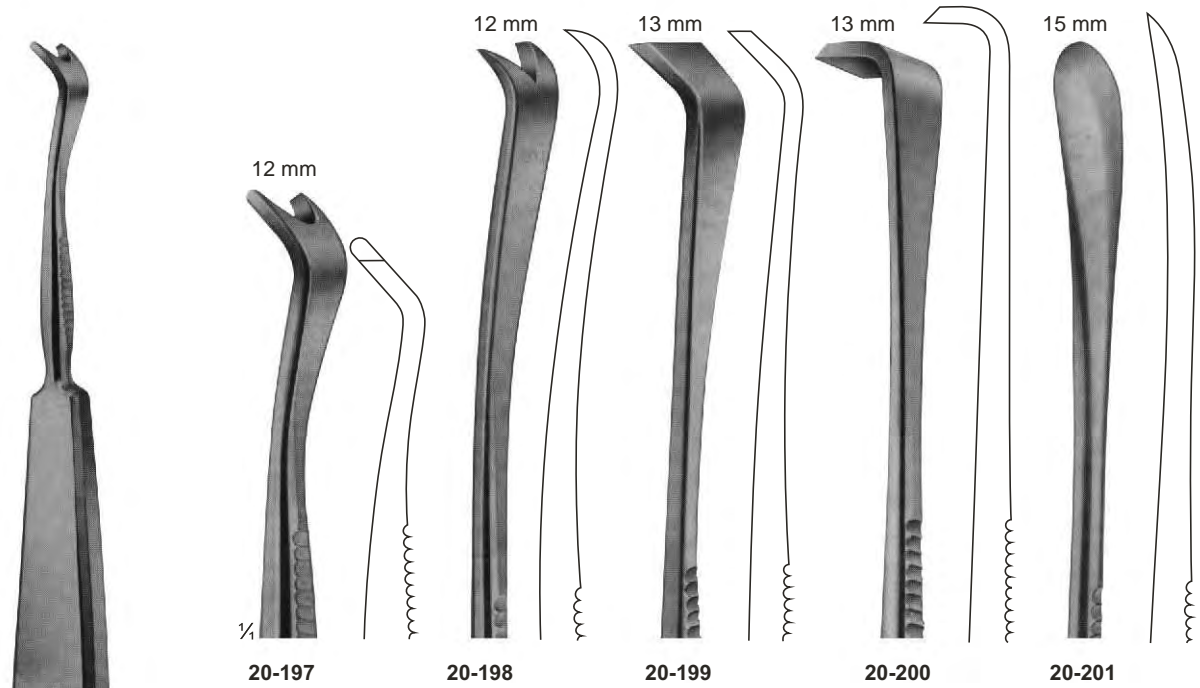

1/2
20-197 - 201
SEMB
230 mm



20-206

20-207

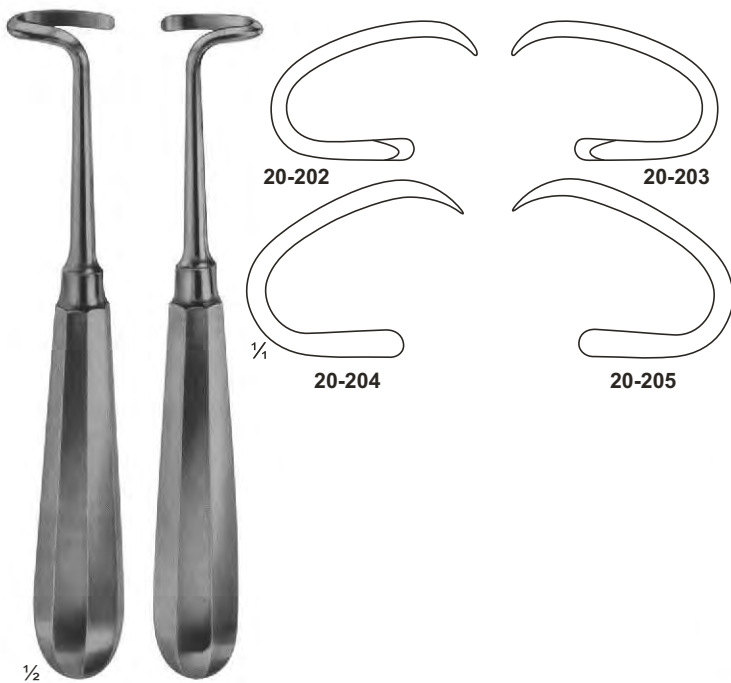

20-202 - 203
DOYEN
for children
20-204 - 205
for adults
175 mm

20-206 - 207
DOYEN
240 mm

Raspatories with HARTPRESS-handle

REALSTAR SURGICAL INSTRUMENTS

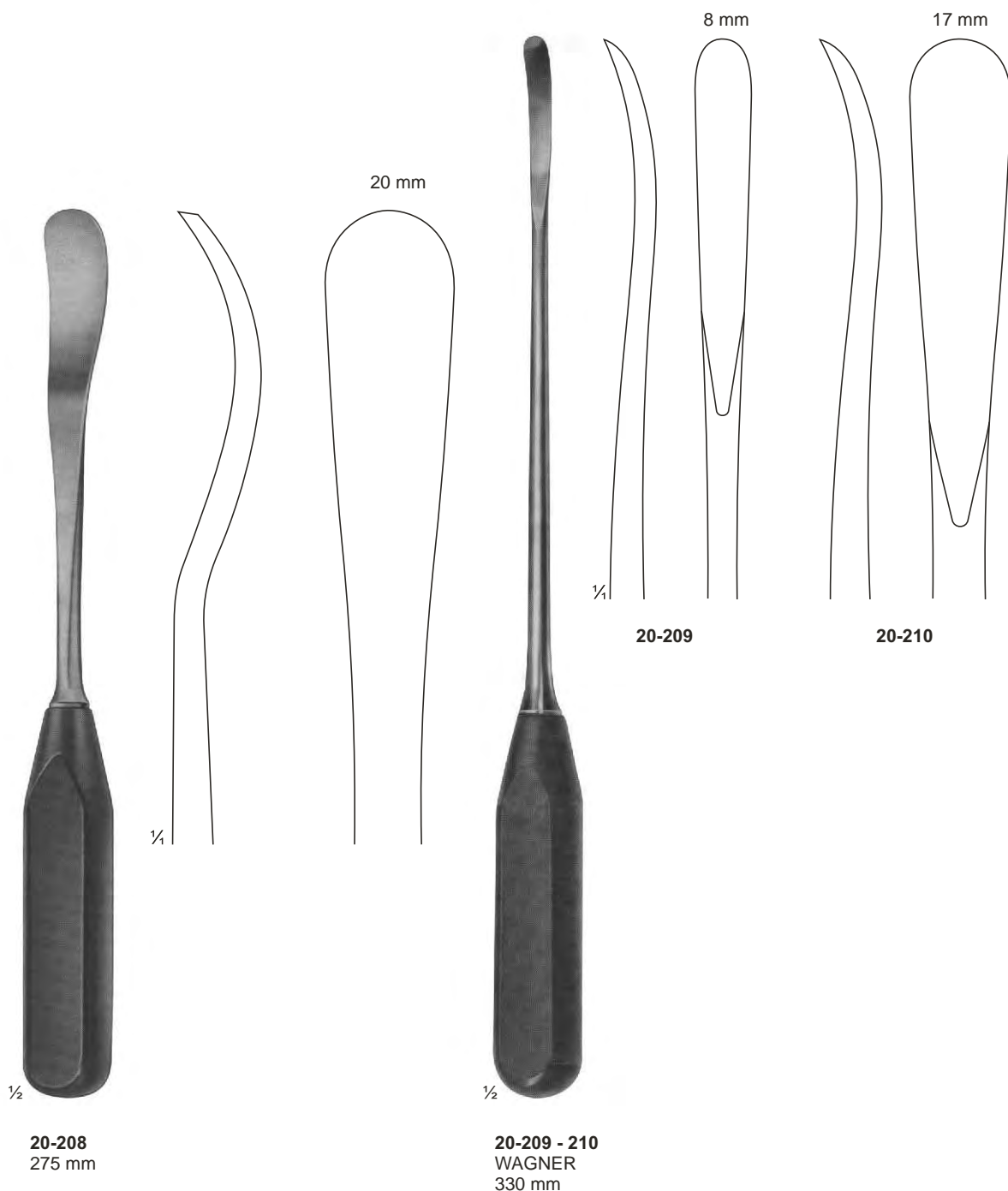

Bone File and Rasps

REALSTAR SURGICAL INSTRUMENTS

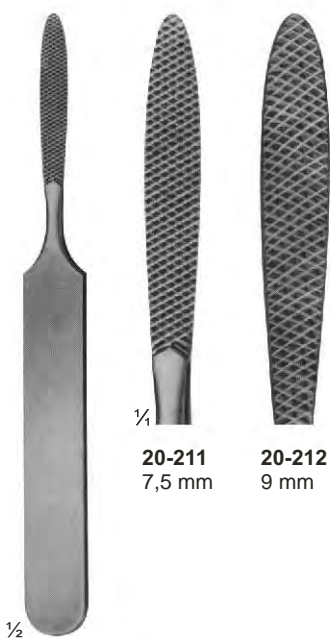

20-211
7,5 mm

20-212
9 mm

20-211
JOSEPH
fine, chequered

20-212
coarse, chequered
165 mm

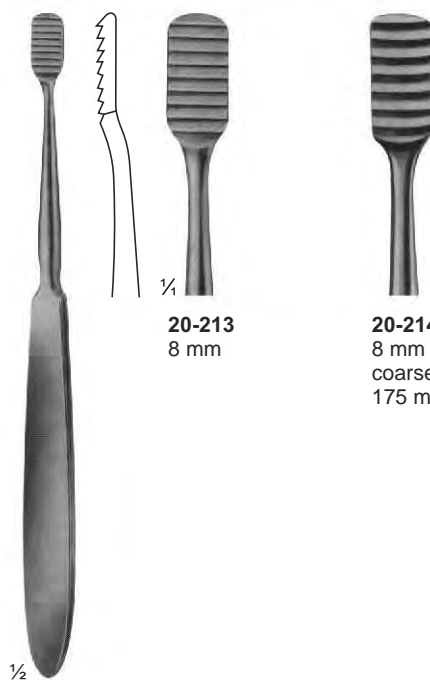

20-213
8 mm

20-214
8 mm
coarse, teeth
175 mm

20-213
LEWIS
fine, teeth



20-215
9 mm

20-215
MALTZ
down stroke
180 mm

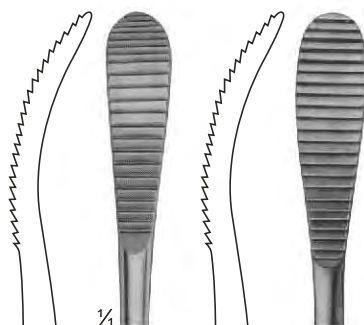

20-216
9 mm

20-217
9 mm



20-216
AUFRICHT
up stroke
20-217
down stroke
220 mm



20-218
6,5 mm

20-218
GALLAHER
190 mm

Bone File and Rasps

REALSTAR SURGICAL INSTRUMENTS

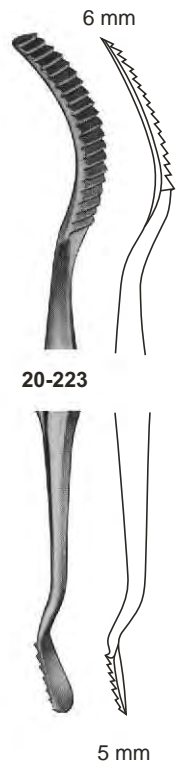
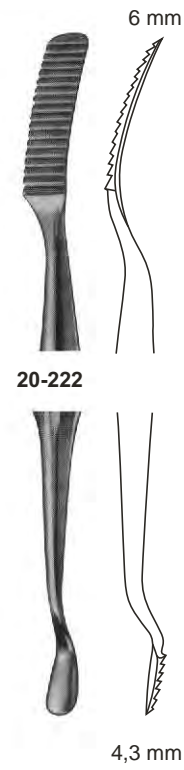
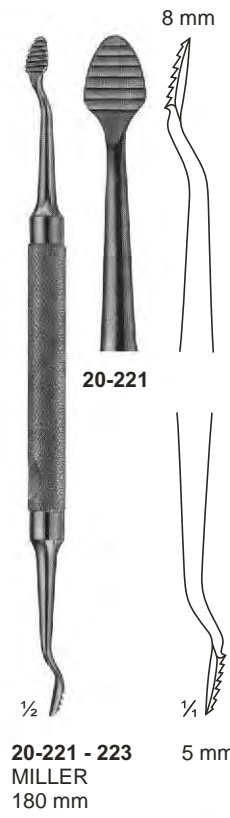
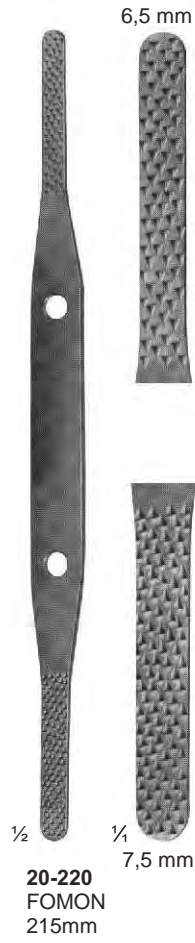
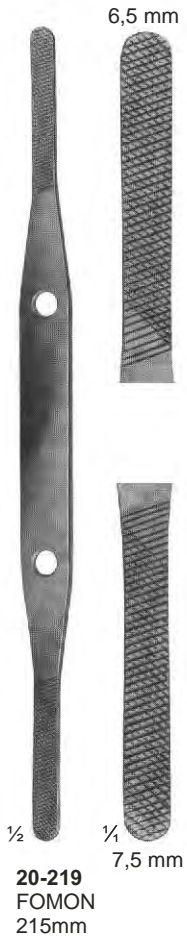

Bone File and Rasps

REALSTAR SURGICAL INSTRUMENTS

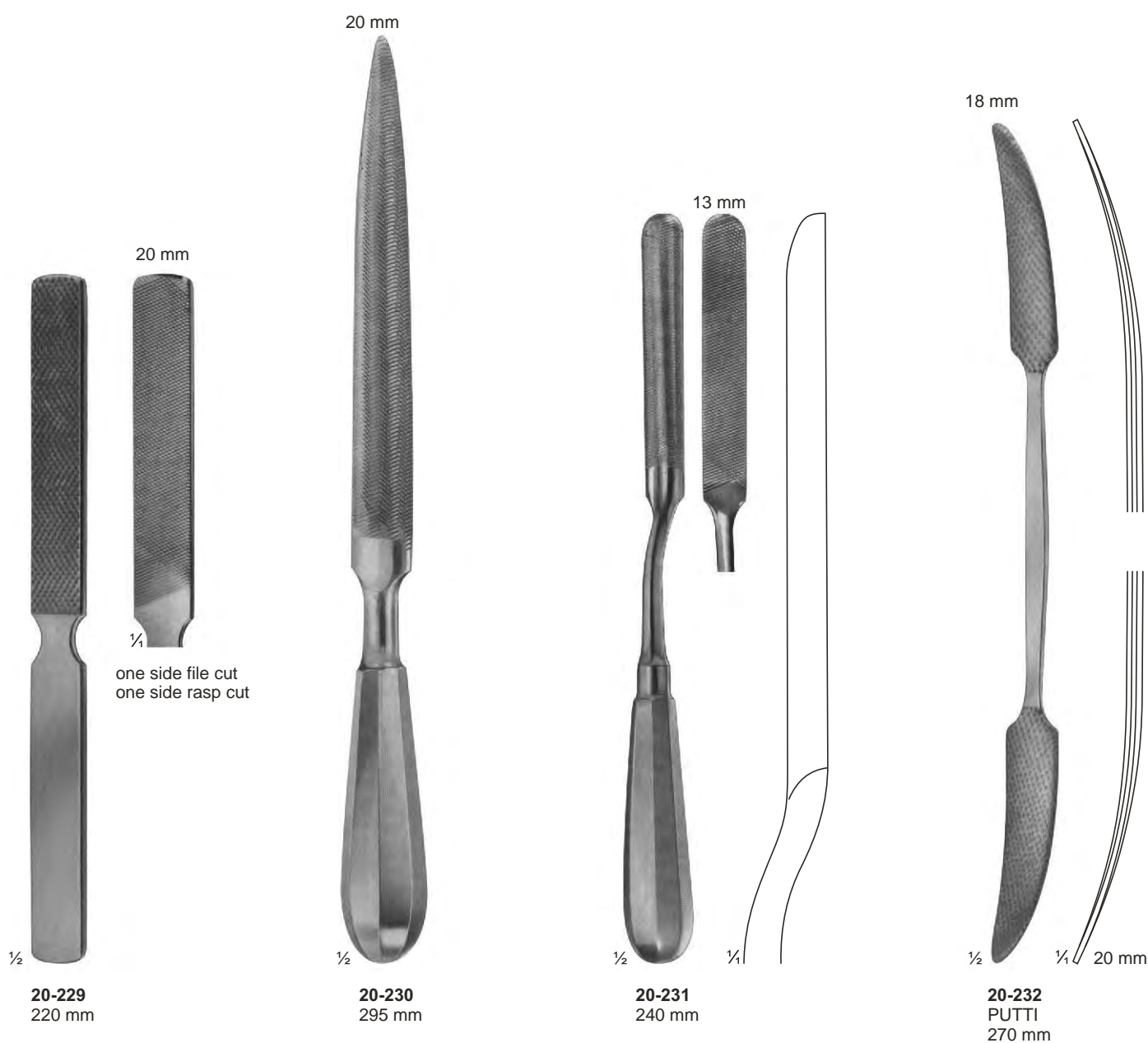

Bone Curettes

REALSTAR SURGICAL INSTRUMENTS



20-233
JACOBSON
140 mm

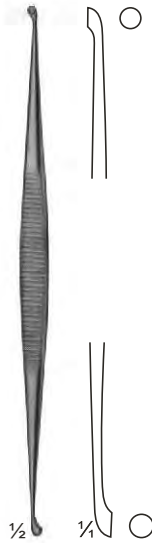

20-234
MARTINI
140 mm



20-235
MARTINI
140 mm



20-236
WILLIGER
145 mm



20-237
JANZEN
160 mm



20-238
BARTH
180 mm

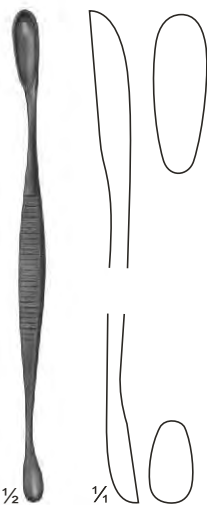

20-239
VOLKMANN
130 mm

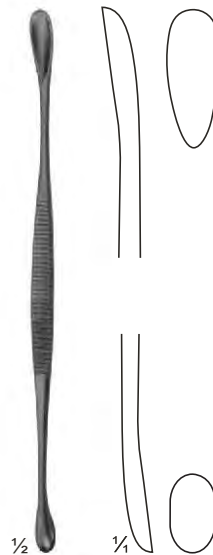

20-240
VOLKMANN
145 mm

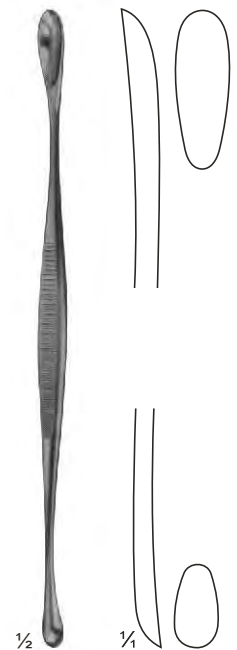

20-241
VOLKMANN
170 mm

Bone Curettes

REALSTAR SURGICAL INSTRUMENTS



20-242
JANSEN
160 mm



20-243
HEMINGWAY
170 mm

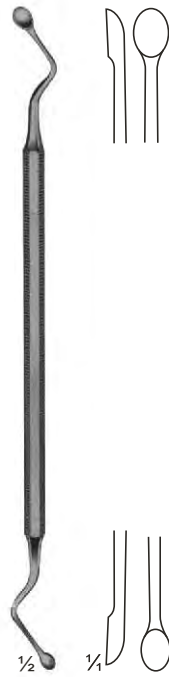

20-244
HEMINGWAY
175 mm

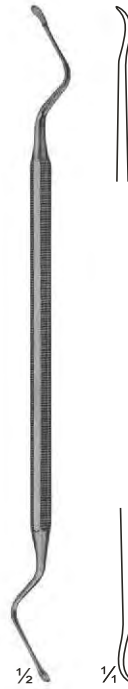

20-245
LUCAS
180 mm

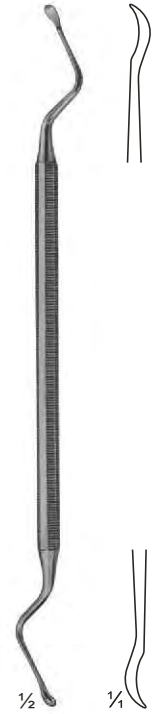

20-246
LUCAS
185 mm

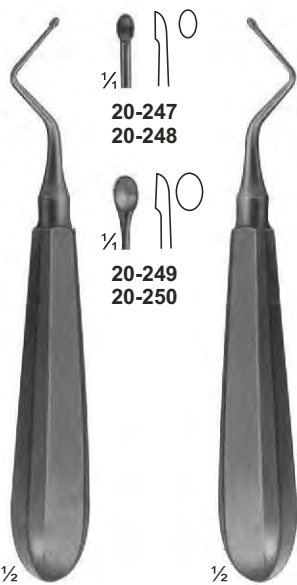

20-247 - 248
KERPEL
145 mm



20-249 - 250
KERPEL
145 mm

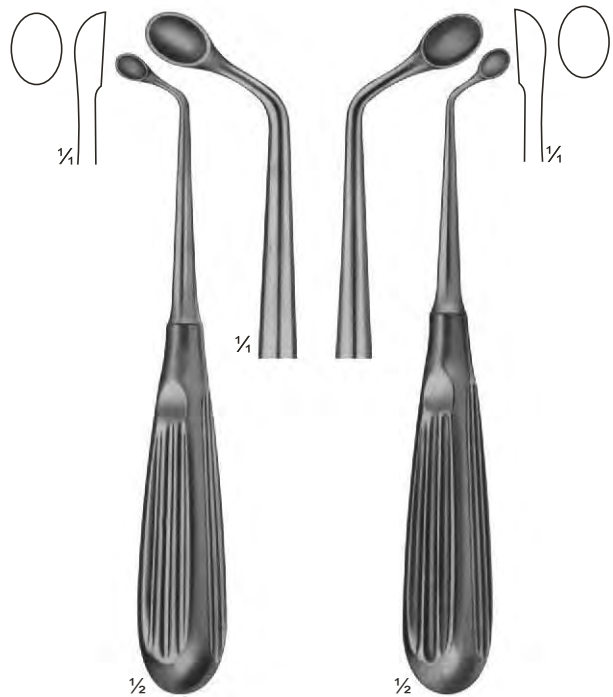

20-251
UFFENORDE
170 mm

20-252
UFFENORDE
170 mm

Bone Currettes

REALSTAR SURGICAL INSTRUMENTS

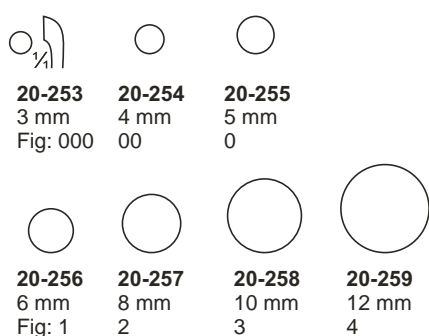

20-253 - 259
BRUNS
165 mm

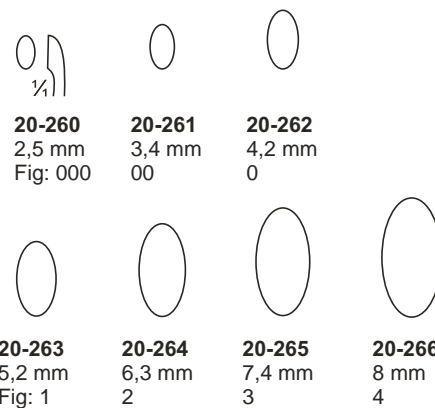

20-260 - 266
SCHEDE
170 mm

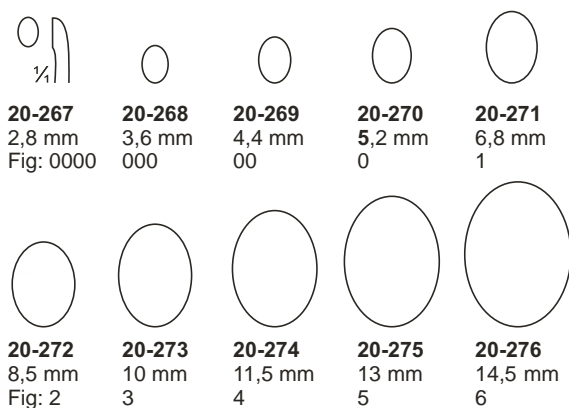

20-267 - 276
VOLKMANN
170 mm

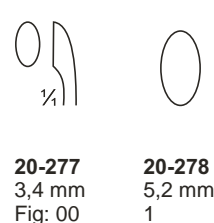

20-277 - 278
WILLIGER
170 mm

Bone Curettes

REALSTAR SURGICAL INSTRUMENTS

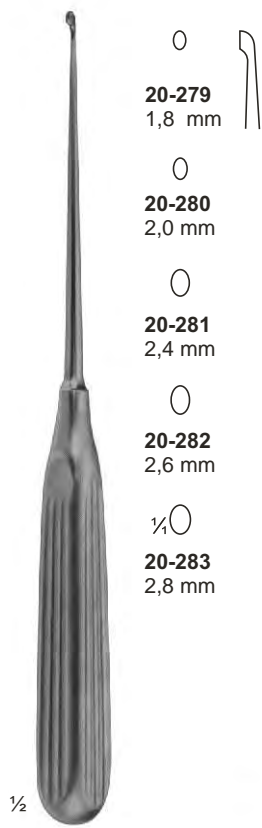

20-279
1,8 mm

20-280
2,0 mm

20-281
2,4 mm

20-282
2,6 mm

20-283
2,8 mm

1/2

20-279 - 283
LEMPERT
215 mm

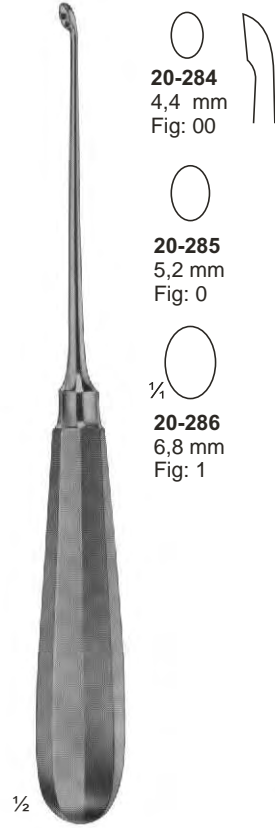

20-284
4,4 mm
Fig: 00

20-285
5,2 mm
Fig: 0

20-286
6,8 mm
Fig: 1

1/2

20-284 - 286
HALLE
215 mm

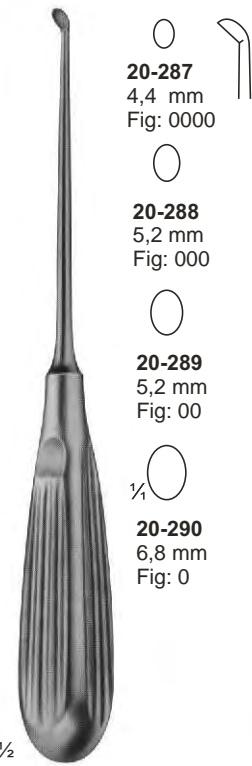

20-287
4,4 mm
Fig: 0000

20-288
5,2 mm
Fig: 000

20-289
5,2 mm
Fig: 00

20-290
6,8 mm
Fig: 0

1/2

20-287 - 290
DAUBENSPECK
200 mm

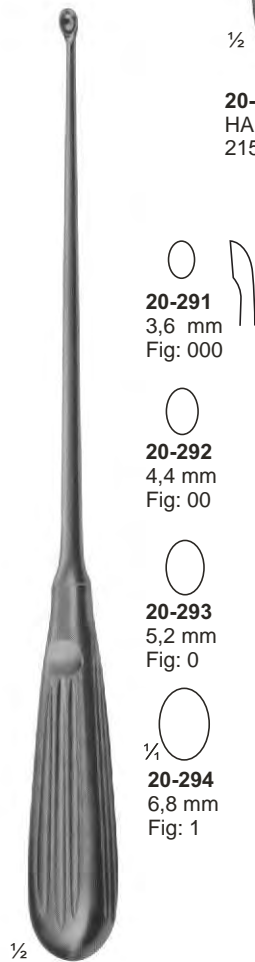

20-291
3,6 mm
Fig: 000

20-292
4,4 mm
Fig: 00

20-293
5,2 mm
Fig: 0

20-294
6,8 mm
Fig: 1

1/2

20-291 - 294
250 mm

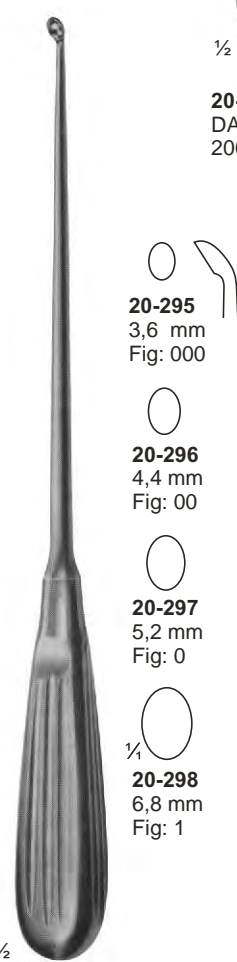

20-295
3,6 mm
Fig: 000

20-296
4,4 mm
Fig: 00

20-297
5,2 mm
Fig: 0

20-298
6,8 mm
Fig: 1

1/2

20-295 - 298
250 mm

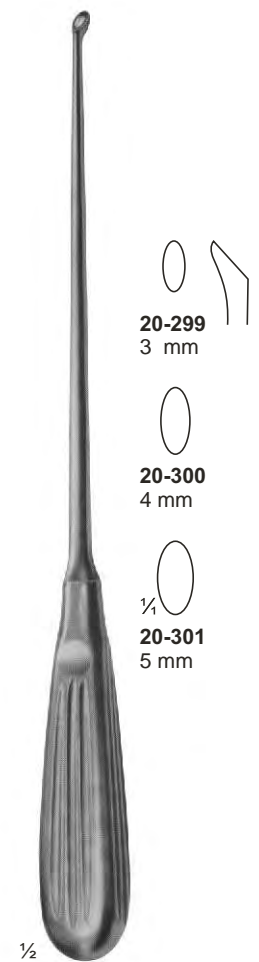

20-299
3 mm

20-300
4 mm

20-301
5 mm

1/2

20-299 - 301
BUSHE
250 mm

Bone Curettes

REALSTAR SURGICAL INSTRUMENTS

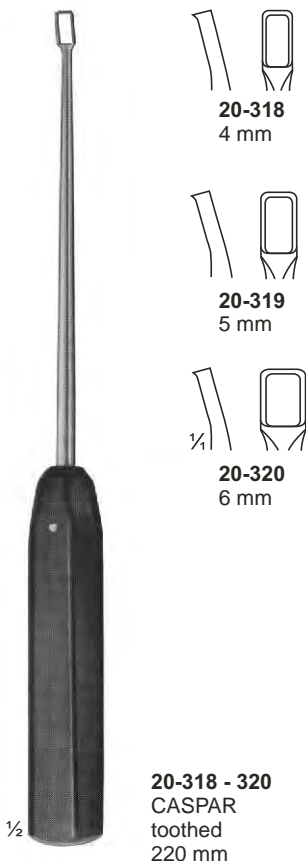
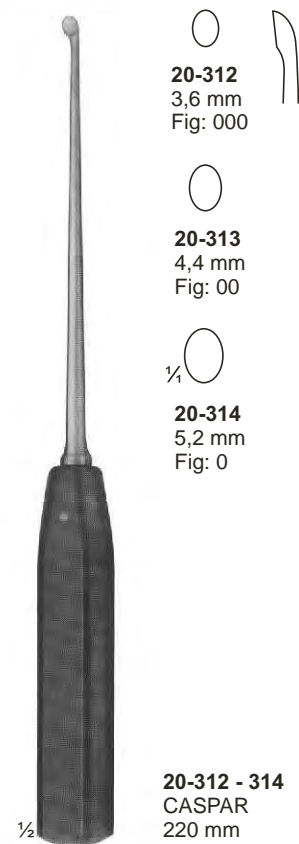
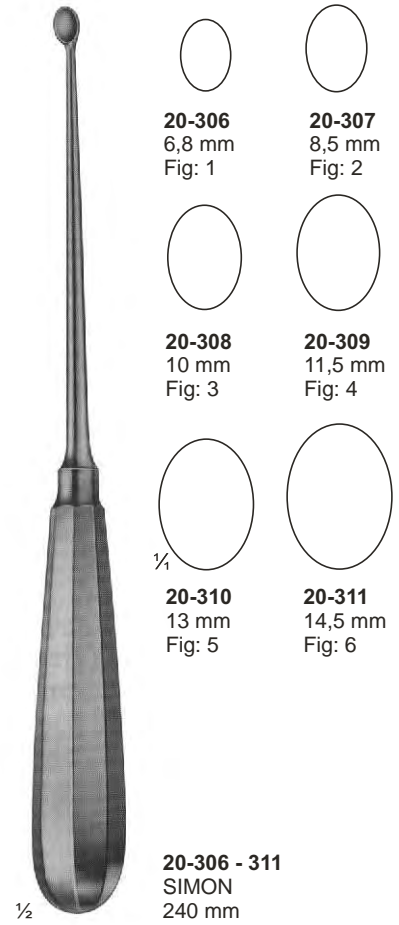

Bone Curettes

REALSTAR SURGICAL INSTRUMENTS

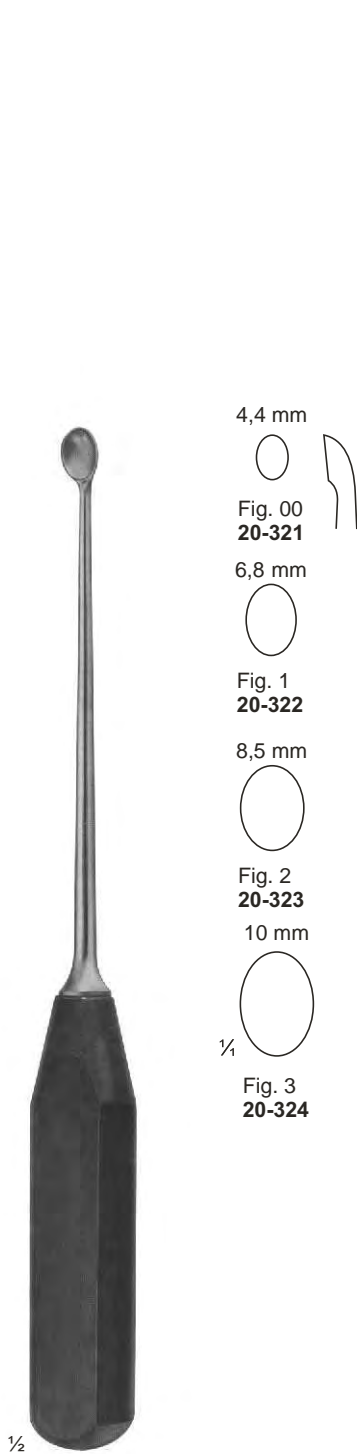

20-321 - 324
270 mm

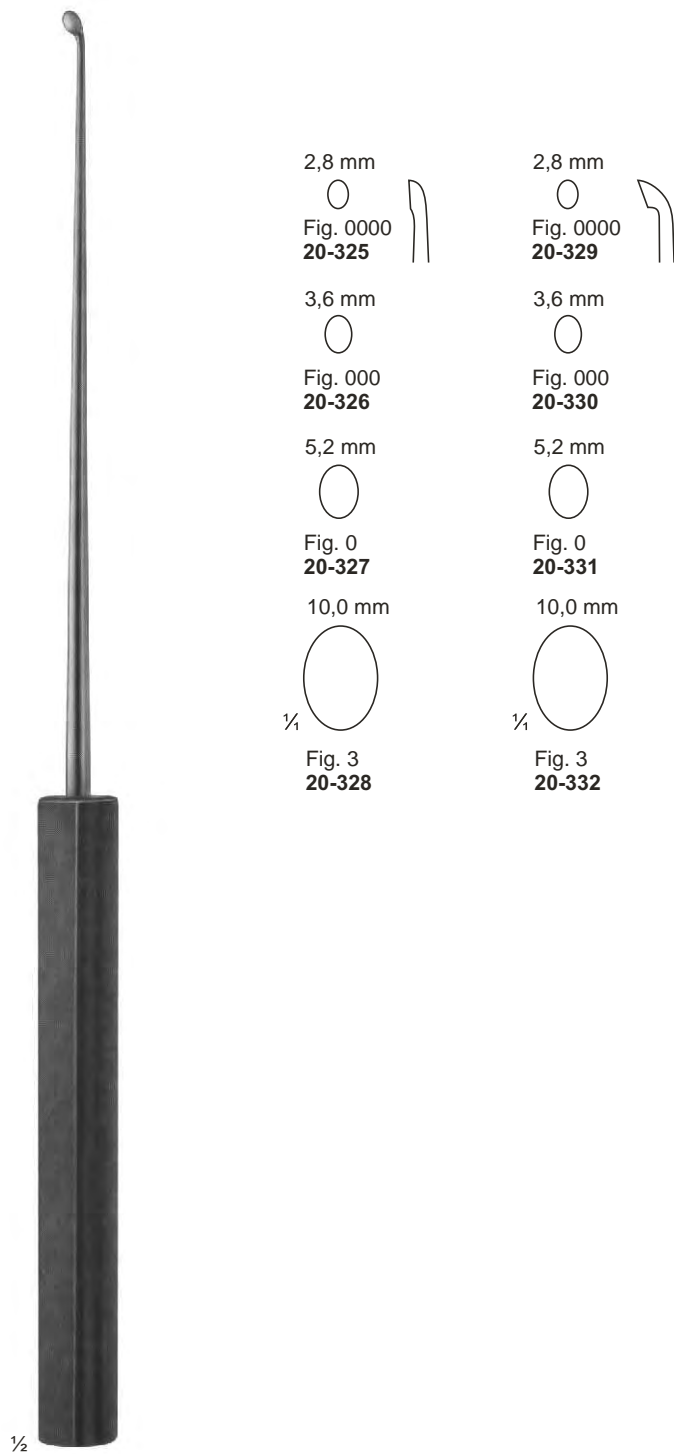

20-325 - 332
SYPERT
380 mm

Mallets

REALSTAR SURGICAL INSTRUMENTS



Ø 20 mm

½

21-101
MEAD
185 g
with interchangeable
plastic disks
190 mm
21-102
pair of spare disks



½

21-103
140 g
with interchangeable
plastic disks
185 mm
21-104
pair of spare disks



Ø 25 mm

½

21-105
COTTLE
140 g
1 Seite convex
1 Side convex
185 mm



Ø 22 mm

½

21-106
165 g
lead filled head
190 mm

Mallets

REALSTAR SURGICAL INSTRUMENTS



21-107
HAJEK
140 g
215 mm



21-108
215 g
with interchangeable
plastic disks
245 mm
21-109
pair of spare disks

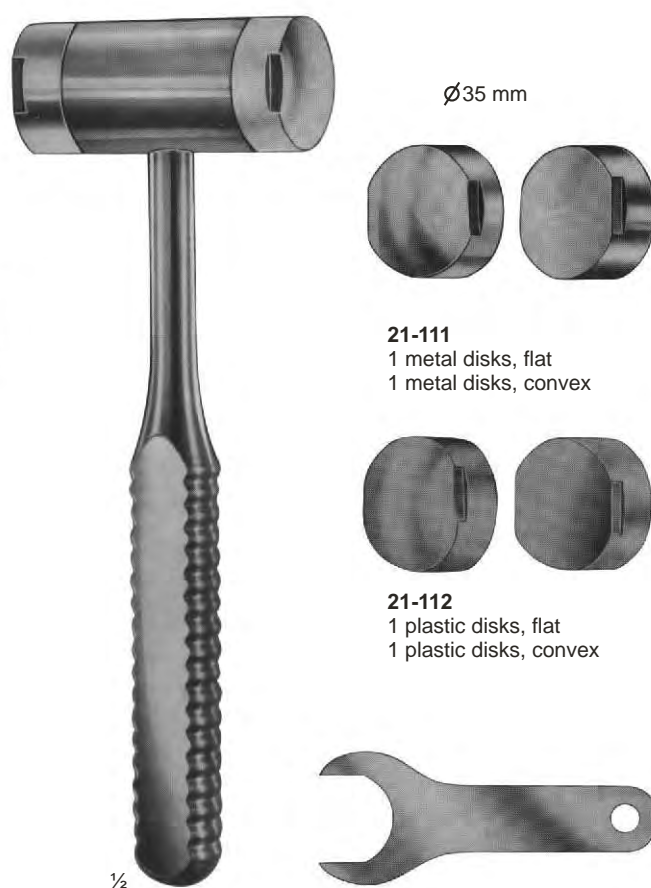

21-110 - 113
WAGNER
complete with:
1 pair of metal disks and
1 pair of plastic disks and
1 wrench 566
235 mm

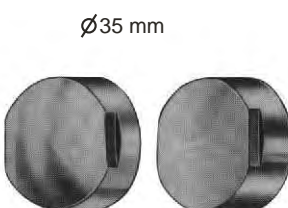

21-111
1 metal disks, flat
1 metal disks, convex

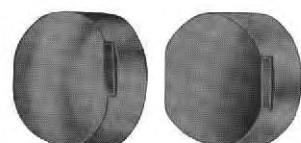

21-112
1 plastic disks, flat
1 plastic disks, convex

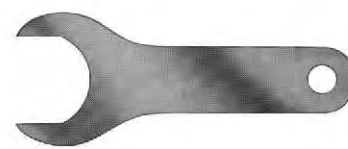

21-113
Wrench

Mallet without disks 130 g

Mallets

REALSTAR SURGICAL INSTRUMENTS



21-114
BERGMANN
245 mm



21-115
BERGMANN
235 mm



21-116
OMBREDANNE
240 mm



21-117
HEATH
copper filled head
700 g
185 mm

Tampers - Osteotomes, Chisels and Gouges

REALSTAR SURGICAL INSTRUMENTS

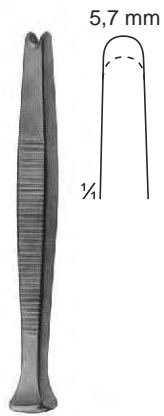

21-118
Haase
100 mm



21-119 - 120
PASSOW
120 mm



21-121 - 123
CASPER
200 mm



21-124 - 126
200 mm

- 21-121
Ø3 mm
- 21-122
Ø5 mm
- 1/4 21-123
Ø8 mm

- 21-124
Ø12 mm
- 21-125
Ø14 mm
- 1/4 21-126
Ø16 mm

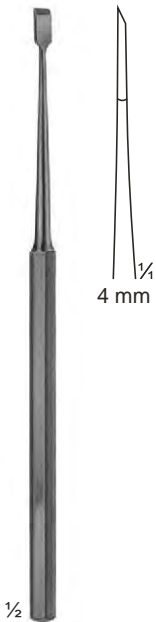

21-127
FREER
Chisel
160 mm



21-128
FREER
Chisel, curved
160 mm

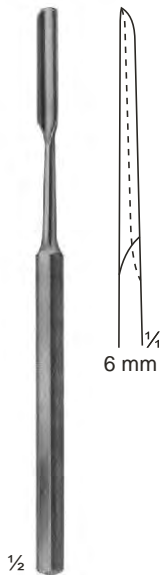

21-129
FREER
Gouge
150 mm

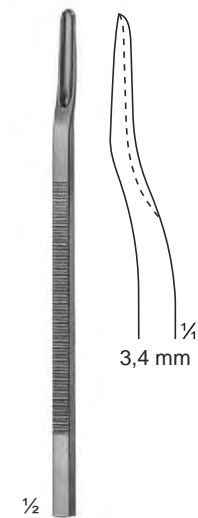

21-130
Scaphoid gouge,
downwards curved
135 mm

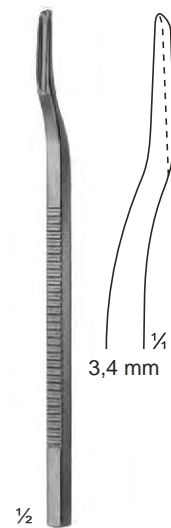

21-131
Scaphoid gouge,
upwards curved
135 mm



21-131A - 133
Mannerfelt
21-131A 4 mm
21-132 6 mm
21-133 8 mm
155 mm

Osteotomes Chisels and Gouges

REALSTAR SURGICAL INSTRUMENTS

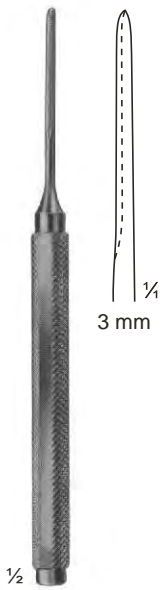

21-134
Mannerfelt
155 mm

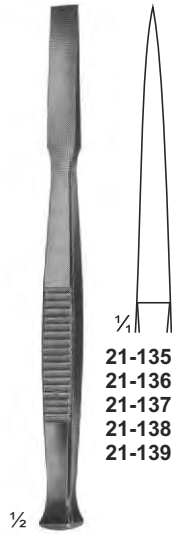

21-135 - 139
Osteotome
140 mm

- 21-135** 4 mm
- 21-136** 6 mm
- 21-137** 8 mm
- 21-138** 10 mm
- 21-139** 12 mm

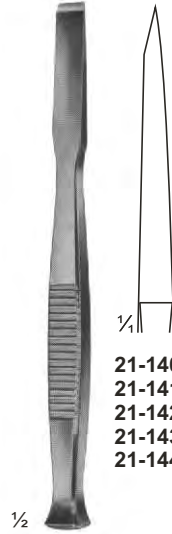

21-140 - 144
Chisels
140 mm

- 21-140** 4 mm
- 21-141** 6 mm
- 21-142** 8 mm
- 21-143** 10 mm
- 21-144** 12 mm

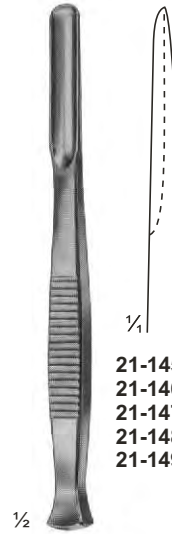

21-145 - 149
Gouges
140 mm

- 21-145** 4 mm
- 21-146** 6 mm
- 21-147** 8 mm
- 21-148** 10 mm
- 21-149** 12 mm

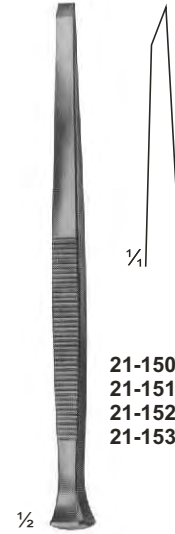

PARTSCH
21-150 - 153
Chisels
140 mm

- 21-150** 3 mm
- 21-151** 4 mm
- 21-152** 5 mm
- 21-153** 6 mm

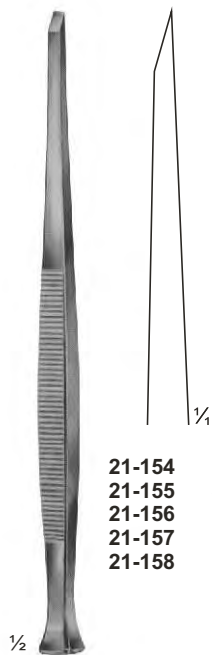

PARTSCH
21-154 - 158
Chisels
170 mm

- 21-154** 3 mm
- 21-155** 4 mm
- 21-156** 5 mm
- 21-157** 6 mm
- 21-158** 7 mm

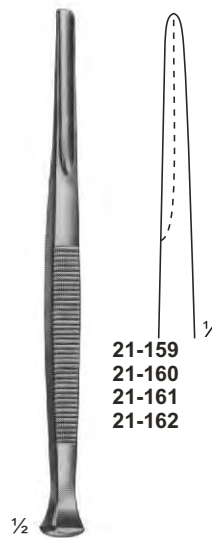

PARTSCH
21-159 - 162
Gouges
140 mm

- 21-159** 3 mm
- 21-160** 4 mm
- 21-161** 5 mm
- 21-162** 6 mm

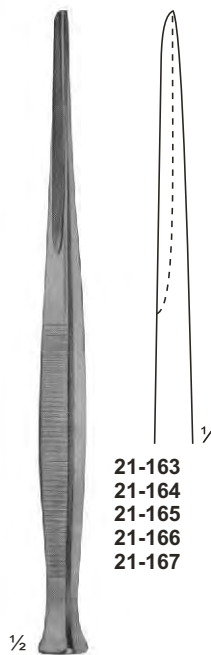

PARTSCH
21-163 - 167
Gouges
170 mm

- 21-163** 3 mm
- 21-164** 4 mm
- 21-165** 5 mm
- 21-166** 6 mm
- 21-167** 7 mm

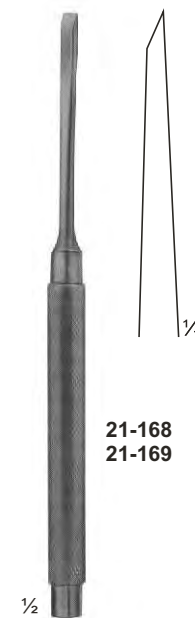

LUCAS
21-168 - 169
Chisels
160 mm

- 21-168** 4 mm
- 21-169** 6 mm

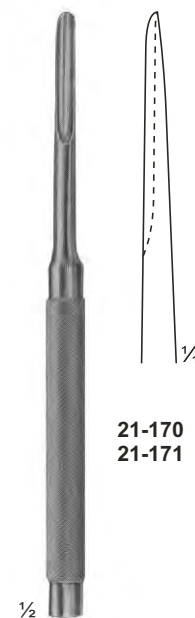

LUCAS
21-170 - 171
Gouges
160 mm

- 21-170** 3 mm
- 21-171** 5 mm

Osteotomes Chisels and Gouges

REALSTAR SURGICAL INSTRUMENTS

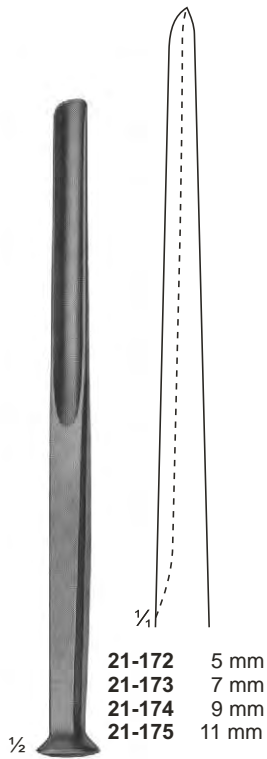

ALEXANDER
21-172 - 175
Gouges
170 mm

- 21-172 5 mm
- 21-173 7 mm
- 21-174 9 mm
- 21-175 11 mm

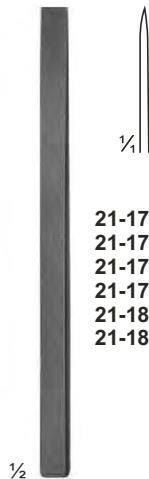

LAMBOTTE
21-176 - 181
Osteotome
125 mm

- 21-176 4 mm
- 21-177 6 mm
- 21-178 8 mm
- 21-179 10 mm
- 21-180 12 mm
- 21-181 15 mm

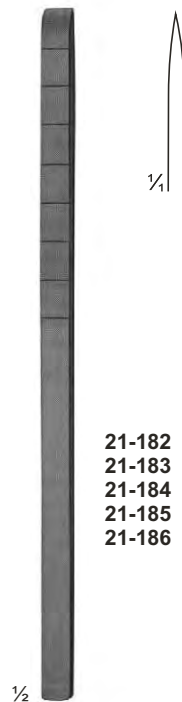

COTTLE
21-182 - 186
Osteotome with depth markings
180 mm

- 21-182 4 mm
- 21-183 6 mm
- 21-184 8 mm
- 21-185 10 mm
- 21-186 12 mm

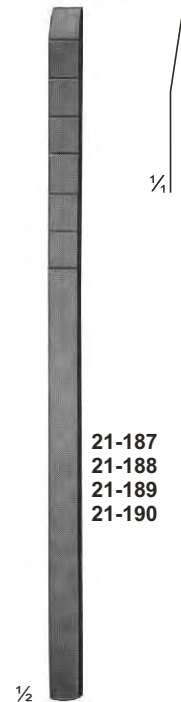

COTTLE
21-187 - 190
Chisel-Osteotomes with depth markings
180 mm

- 21-187 4 mm
- 21-188 7 mm
- 21-189 9 mm
- 21-190 12 mm

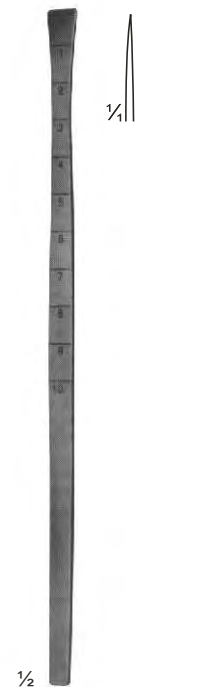

COTTLE
21-191
Fishtail Chisel, with protected ends
180 mm

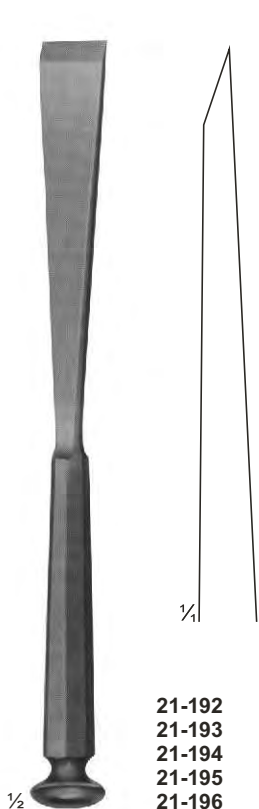

STILLE
21-192 - 196
Chisels
205 mm

- 21-192 10 mm
- 21-193 12 mm
- 21-194 15 mm
- 21-195 20 mm
- 21-196 25 mm

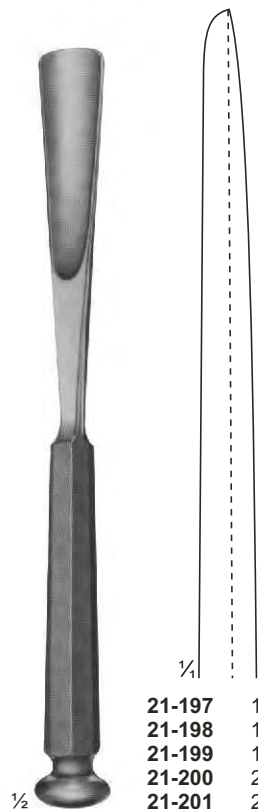

STILLE
21-197 - 201
Gouges
205 mm

- 21-197 10 mm
- 21-198 12 mm
- 21-199 15 mm
- 21-200 20 mm
- 21-201 25 mm

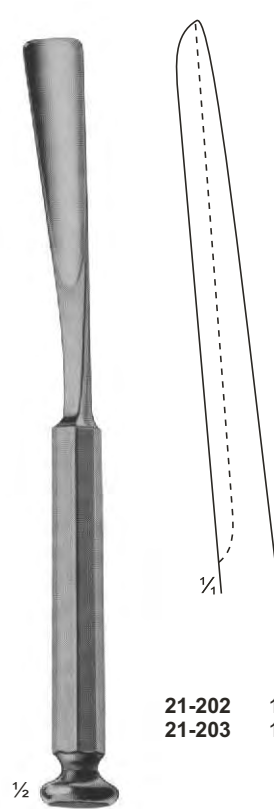

WALTER
21-202 - 203
Osteotomes gouges for taking grafts from the rib
205 mm

- 21-202 10 mm
- 21-203 15 mm

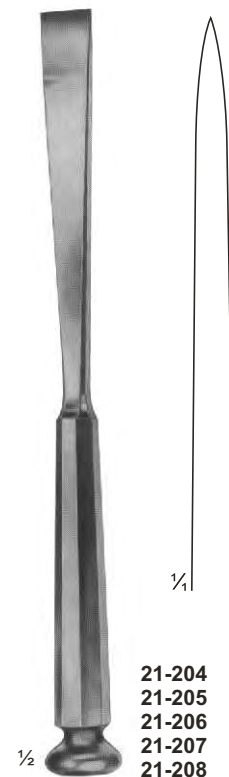

STILLE
21-204 - 208
Osteotomes
205 mm

- 21-204 8 mm
- 21-205 12 mm
- 21-206 15 mm
- 21-207 20 mm
- 21-208 25 mm

Osteotomes

REALSTAR SURGICAL INSTRUMENTS

<p>STILLE 21-209 - 213 Osteotomes 205 mm</p>	<p>21-209 10 mm</p>	<p>STILLE 21-214 - 218 Osteotomes, curved 205 mm</p>	<p>21-214 10 mm</p>	<p>LAMBOTTE 21-219 - 230 Osteotomes 245 mm</p>	<p>21-219 4 mm</p>	<p>LAMBOTTE 21-231 - 236 Osteotomes, curved 245 mm</p>	<p>21-231 8 mm</p>
	<p>21-210 12 mm</p>		<p>21-215 12 mm</p>		<p>21-220 8 mm</p>		<p>21-232 13 mm</p>
	<p>21-211 15 mm</p>		<p>21-216 15 mm</p>		<p>21-221 10 mm</p>		<p>21-233 18 mm</p>
	<p>21-212 20 mm</p>		<p>21-217 20 mm</p>		<p>21-222 13 mm</p>		<p>21-234 25 mm</p>
	<p>21-213 25 mm</p>		<p>21-218 25 mm</p>		<p>21-223 15 mm</p>		<p>21-235 30 mm</p>
		<p>21-224 18 mm</p>	<p>21-236 38 mm</p>				
		<p>21-225 20 mm</p>					
		<p>21-226 25 mm</p>					
		<p>21-227 30 mm</p>					
		<p>21-228 38 mm</p>					
		<p>21-229 44 mm</p>					
		<p>21-230 50 mm</p>					

Osteotomes, Chisels and Gouges with HARTPRESS -handle

REALSTAR SURGICAL INSTRUMENTS



- 21-237 4 mm
- 21-238 6 mm
- 21-239 8 mm
- 21-240 10 mm
- 21-241 12 mm



- 21-242 4 mm
- 21-243 6 mm
- 21-244 8 mm
- 21-245 10 mm
- 21-246 12 mm



- 21-247 5 mm
- 21-248 7 mm
- 21-249 10 mm
- 21-250 15 mm
- 21-251 20 mm
- 21-252 25 mm
- 21-253 30 mm

LEXER-MINI
21-237 - 241
Osteotomes
180 mm

LEXER-MINI
21-242 - 246
Gouges
180 mm

LEXER
21-247 - 253
Osteotomes
220 mm



- 21-254 5 mm
- 21-255 7 mm
- 21-256 10 mm
- 21-257 15 mm
- 21-258 20 mm
- 21-259 25 mm
- 21-260 30 mm

LEXER
21-254 - 260
Gouges
220 mm



LEXER
21-261
Gouge for
removing broken
screws
220 mm



- 21-262 5,5 mm
- 21-263 9,0 mm

ZIELKE
21-262 - 263
Gouge for
scoliose-operations
230 mm

Osteotomes ,Chisels and Gouges with HARTPRESS -handle

REALSTAR SURGICAL INSTRUMENTS

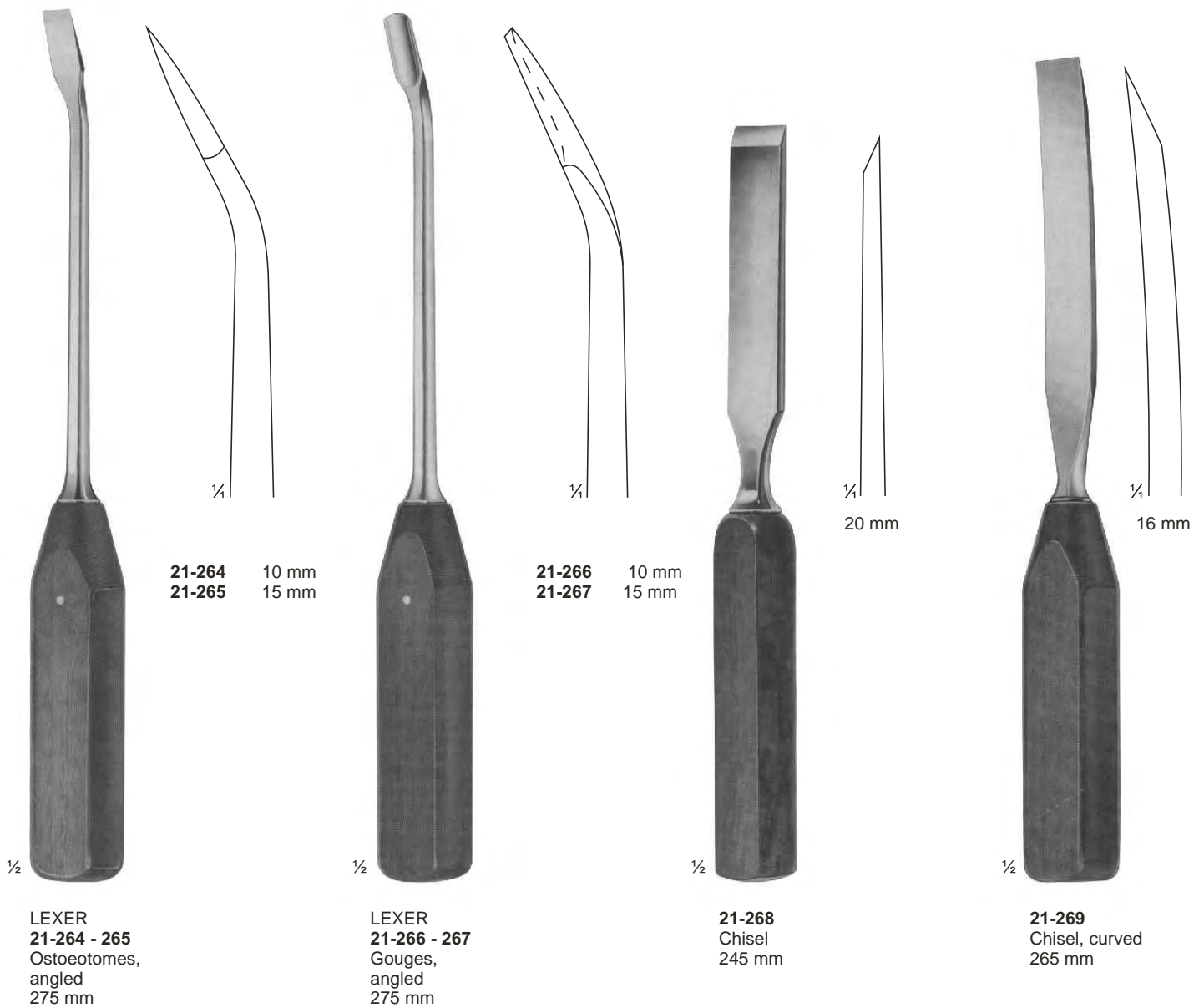

LEXER
21-264 - 265
Osteotomes,
angled
275 mm

LEXER
21-266 - 267
Gouges,
angled
275 mm

21-268
Chisel
245 mm

21-269
Chisel, curved
265 mm

Reposition Forceps

REALSTAR SURGICAL INSTRUMENTS



22-101
Reposition forceps,
for small fragments
135 mm

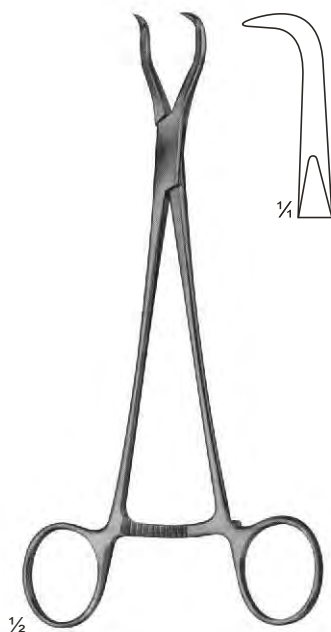

HAASE
22-102
Reposition forceps,
for mandibular
fractures
165 mm

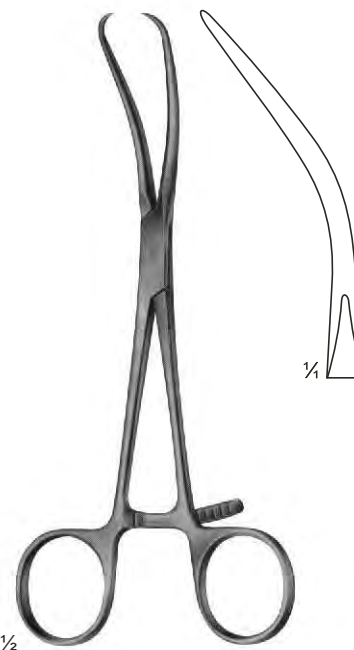

REILL
22-103
Reposition forceps,
170 mm



22-104
Reposition forceps
205 mm

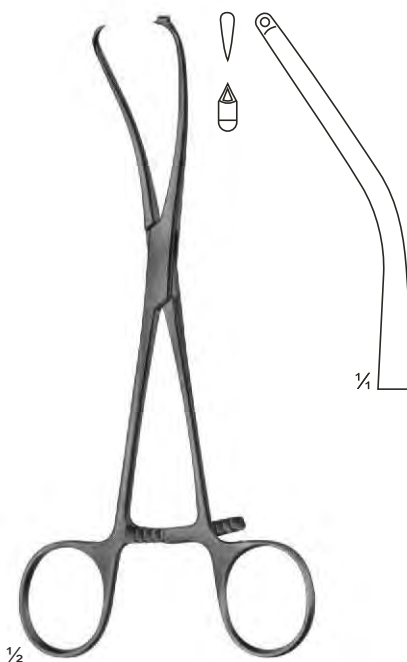

MEYER
22-105
Reposition forceps
for fingers, with drill
guide for KIRSCHNER
wires up to diam. 1.0 mm
170 mm

Reposition Forceps, Bone Holding Forceps

REALSTAR SURGICAL INSTRUMENTS



22-106
Patella forceps
185 mm



22-107
Forceps with
ratchet fixation
140 mm



22-108
Forceps with
thread fixation
170 mm



22-109
Forceps with
thread fixation
235 mm

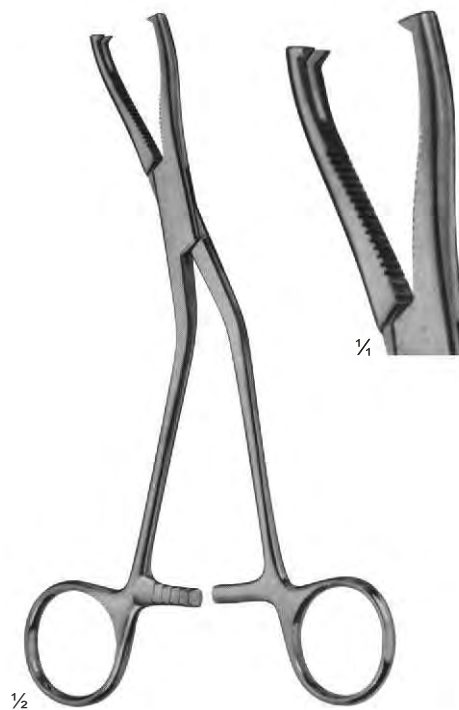

22-110
DINGMANN
185 mm

Bone Holding Forceps

REALSTAR SURGICAL INSTRUMENTS



22-111
Sequestrum
forceps
200 mm



22-112
VAN BUREN
Sequestrum
forceps
225 mm



22-113
LANGENBECK
Sequestrum
forceps
205 mm



22-114
FERGUSSON
Sequestrum
forceps
205 mm

Bone Holding Forceps

REALSTAR SURGICAL INSTRUMENTS

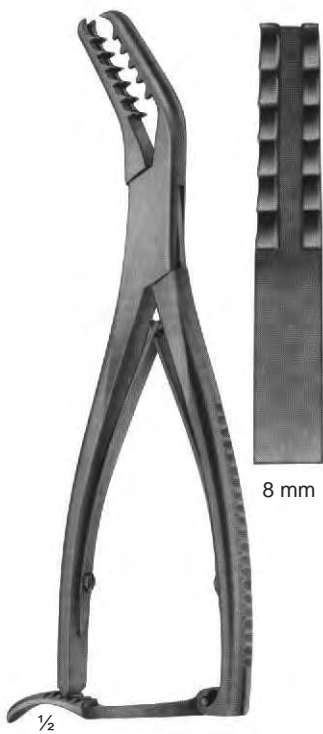
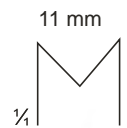
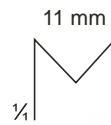
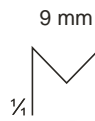
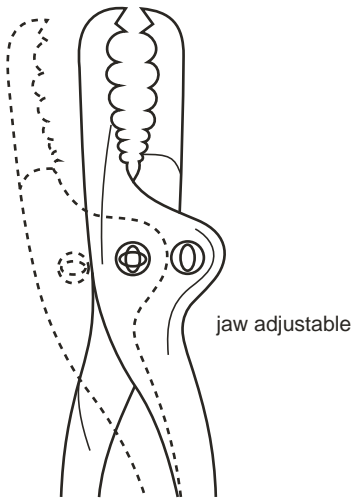

22-115
SEMB
190 mm



22-116
FARABEU
230 mm



22-117
FARABEU
255 mm



22-118
FARABEU-LAMBOTTE
255 mm

Bone Holding Forceps

REALSTAR SURGICAL INSTRUMENTS



22-119
KERN-LANE
240 mm



22-120
LANE
330 mm



22-121
KERN-LANE
240 mm

Bone Holding Forceps

REALSTAR SURGICAL INSTRUMENTS



Bone Holding Forceps

REALSTAR SURGICAL INSTRUMENTS



22-124 - 128

- 22-124 145 mm
- 22-125 190 mm
- 22-126 240 mm
- 22-127 260 mm
- 22-128 280 mm

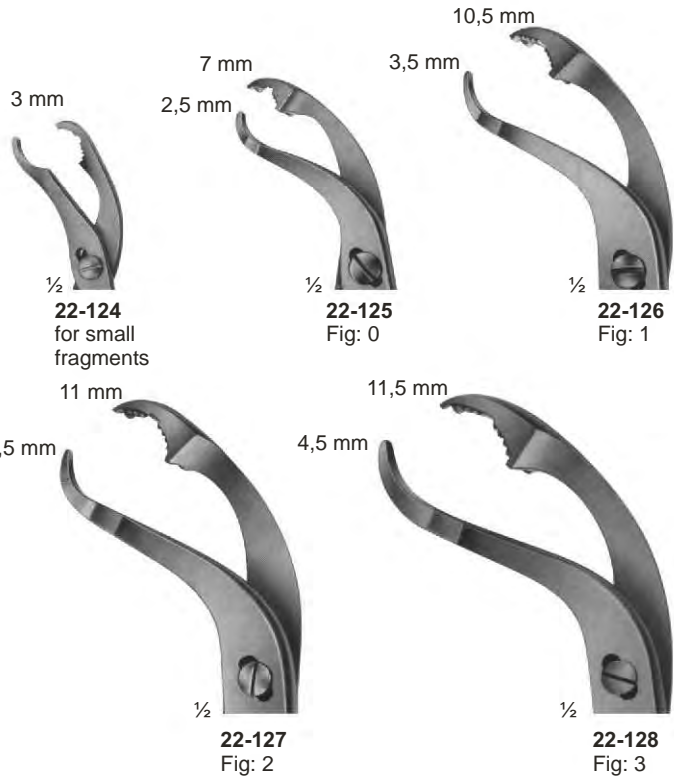

22-124 for small fragments

22-125 Fig: 0

22-126 Fig: 1

22-127 Fig: 2

22-128 Fig: 3

Self-centering forceps with thread fixation



22-129 - 131 VERBRUGGE with lip joint

- 255 mm
- 265 mm
- 270 mm

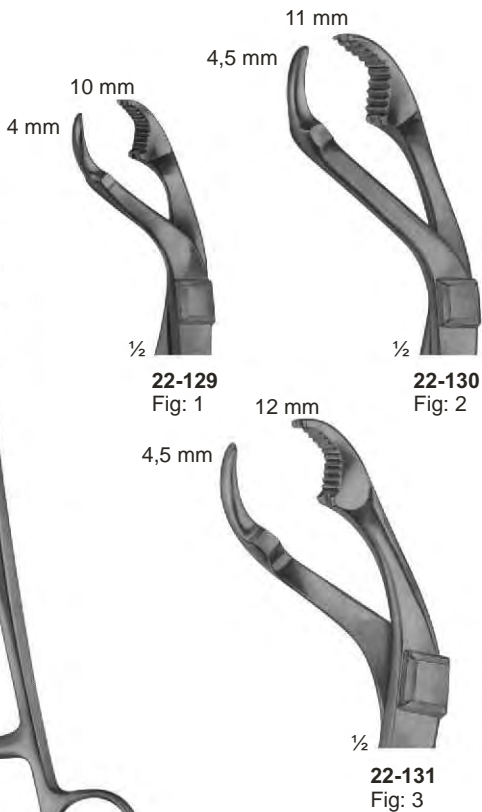

22-129 Fig: 1

22-130 Fig: 2

22-131 Fig: 3



22-132 LAMBOTTE 265 mm

Bone Clamps

REALSTAR SURGICAL INSTRUMENTS



22-133 - 134
LOWMAN
22-133 170 mm
22-134 205 mm



22-135
LOWMAN-GERSTER
210 mm



22-136
LOWMAN-HOGLUND
175 mm

Synovectomy-Rongeurs, Bone Rongeurs

REALSTAR SURGICAL INSTRUMENTS



22-137 - 138
Synovectomy rongeur
width of jaws 1.2 mm
130 mm

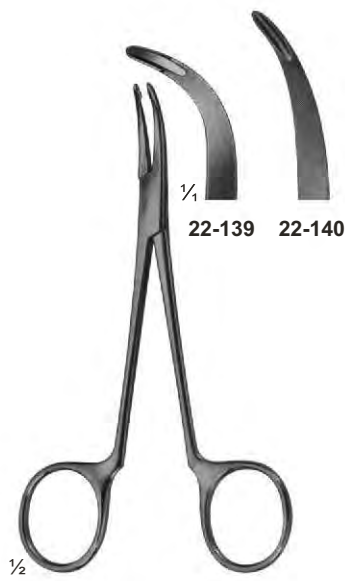

22-139 - 140
Synovectomy rongeur
width of jaws 2.0 mm
130 mm



22-141
STELLBRINK
Synovectomy rongeur
175 mm



22-142
STELLBRINK
Synovectomy rongeur
170 mm



22-143
LURE-FRIEDMANN
145 mm

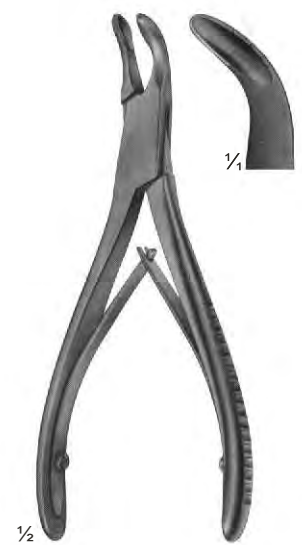

22-144
140 mm

Bone Rongeurs

REALSTAR SURGICAL INSTRUMENTS



22-145
LURE
150 mm

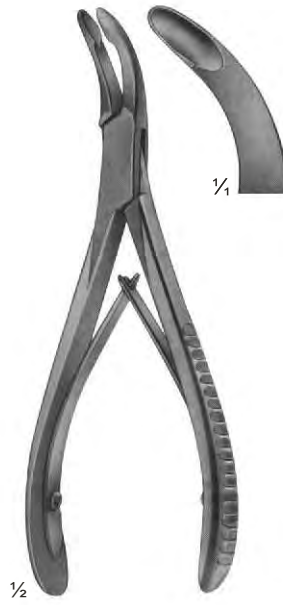

22-146
LURE
155 mm

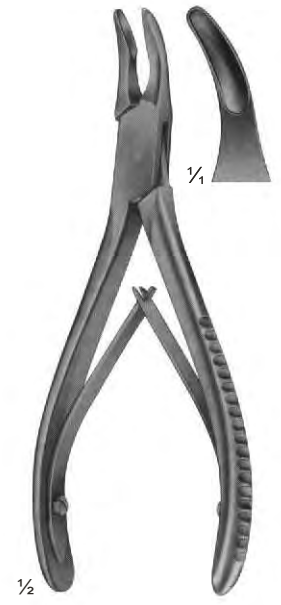

22-147
BLUMENTHAL
155 mm

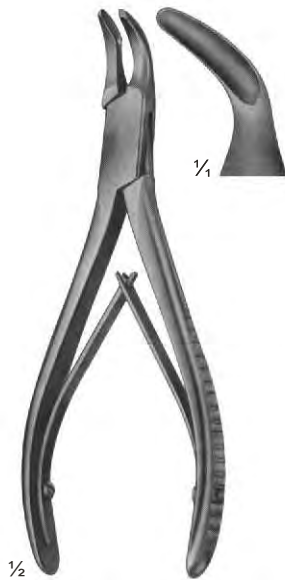

22-148
BLUMENTHAL
150 mm



22-149 - 150
JANSEN
175 mm

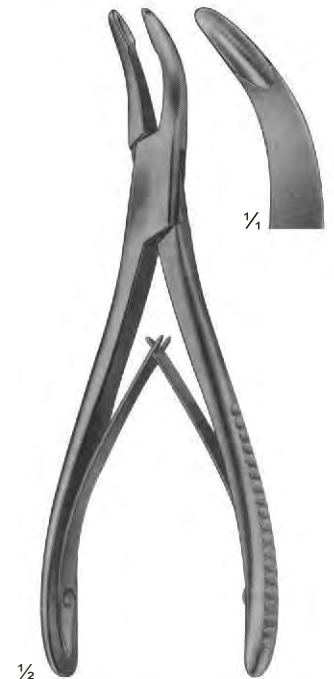

22-151
BANE-HARTMANN
175 mm

Bone Rongeurs

REALSTAR SURGICAL INSTRUMENTS



22-152
ALEXANDER
140 mm

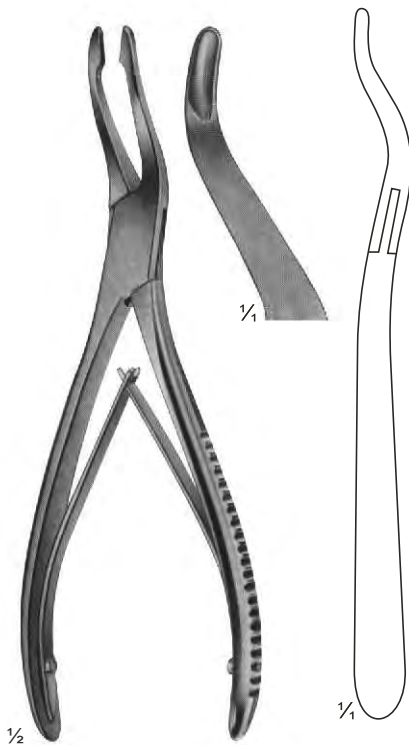

22-153
JANSEN
190 mm

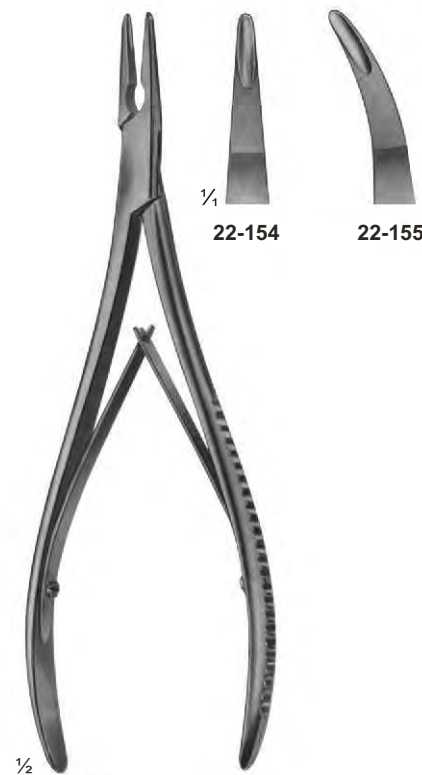

22-154 - 155
LEMPERT
200 mm

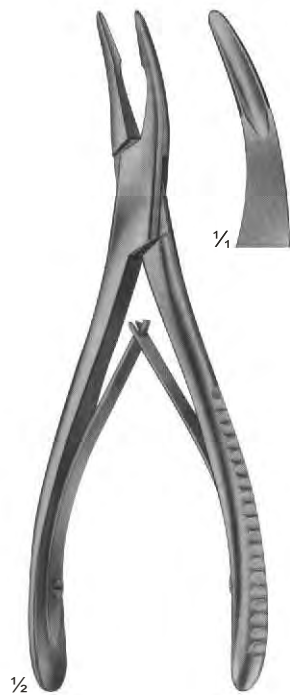

22-156
BEYER
180 mm

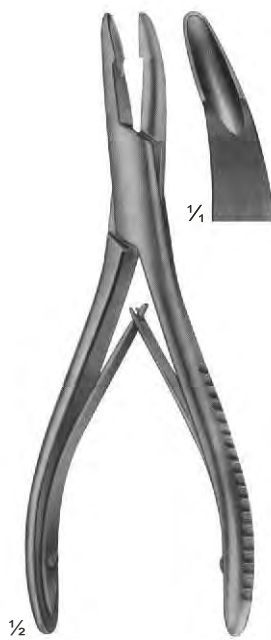

22-157
MEAD
165 mm

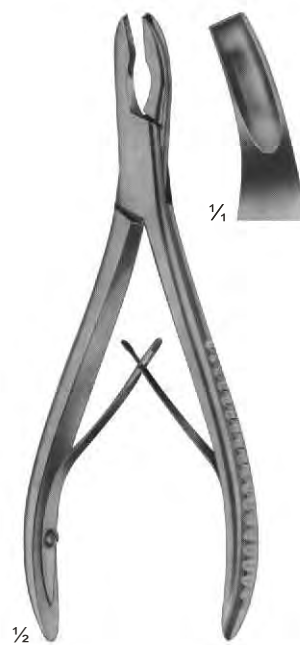

22-158
MEAD
165 mm

Bone Rongeurs

REALSTAR SURGICAL INSTRUMENTS

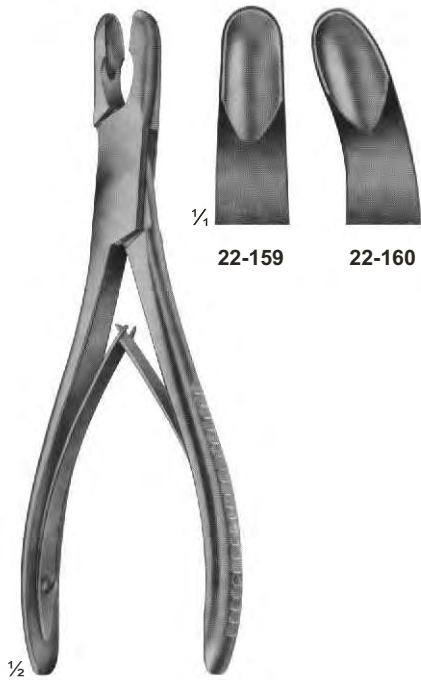

22-159 22-160

22-159 - 160
LURE
175 mm

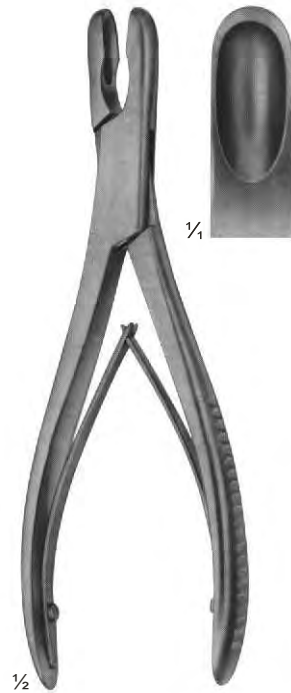

22-161
LURE
180 mm



22-162
LURE
180 mm

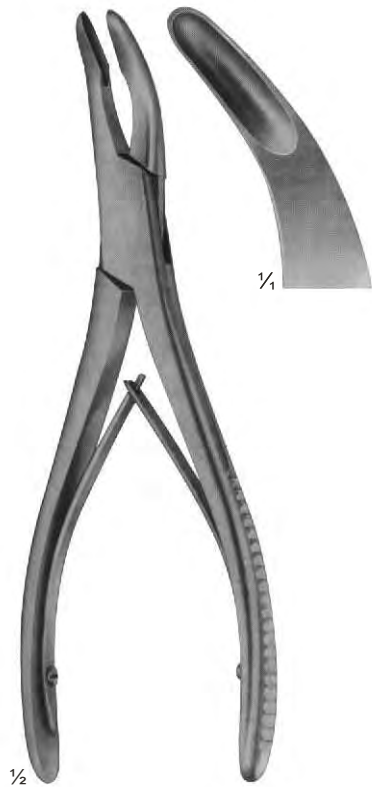

22-163
OLIVECRONA
205 mm



22-164 - 165
BOHLER
155 mm



22-166
MARQUARTD
200 mm

Bone Rongeurs

REALSTAR SURGICAL INSTRUMENTS

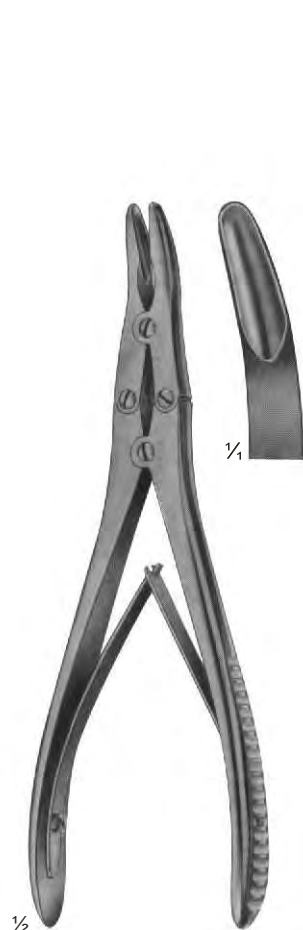

22-167
RUSKIN
190 mm



22-168
ROTTGEN-RUSKIN
240 mm



22-169 - 170
ECHLIN
230 mm

Bone Rongeurs

REALSTAR SURGICAL INSTRUMENTS



22-171
STILLE
235 mm



22-172
LEKSELL-STILLE
240mm



22-173
STILLE-RUSKIN
240mm



22-174
LURE-STILLE
225 mm



22-175
LURE-STILLE
225 mm

Vena-Cava Clamps

REALSTAR SURGICAL INSTRUMENTS



17-233 - 235
DE BAKEY
205 mm, 225 mm, 240 mm



17-233 41 mm
17-234 65 mm
17-235 80 mm



17-236 - 238
DE BAKEY
200 mm, 225 mm, 240 mm



17-236 41 mm
17-237 65 mm
17-238 80 mm



17-239
DE BAKEY
210 mm



1/4
51 mm



17-240
DE BAKEY
210 mm



15°
1/4
51 mm



17-241
DE BAKEY
160 mm



1/4
56 mm

Bone Cutting Forceps

REALSTAR SURGICAL INSTRUMENTS

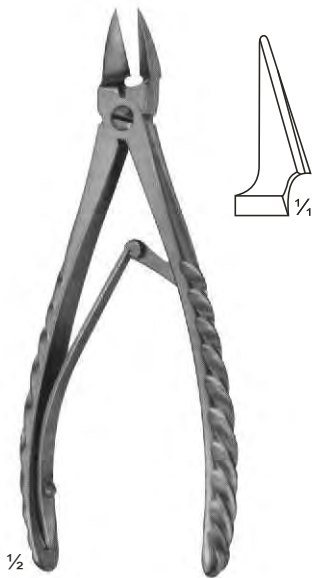

22-178
STAMM
150 mm



22-179
KAZANJIAN
185 mm



22-180 - 183
LISTON



22-180
140 mm



22-181
170 mm



22-182
200 mm



22-183
220 mm

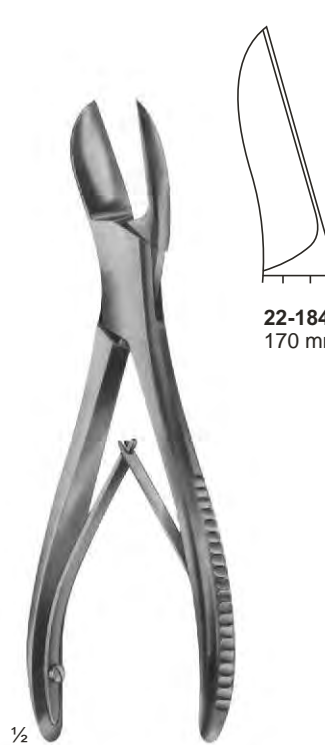

22-184 - 186
LISTON



22-184
170 mm

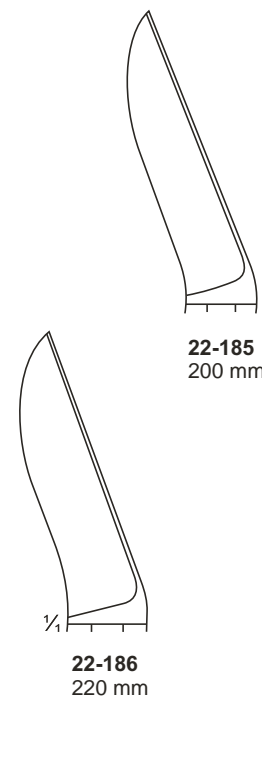

22-185
200 mm

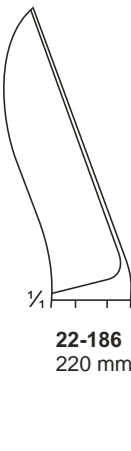

22-186
220 mm

Bone Cutting Forceps

**REALSTAR SURGICAL
INSTRUMENTS**



**22-187
BOHLER**
145 mm

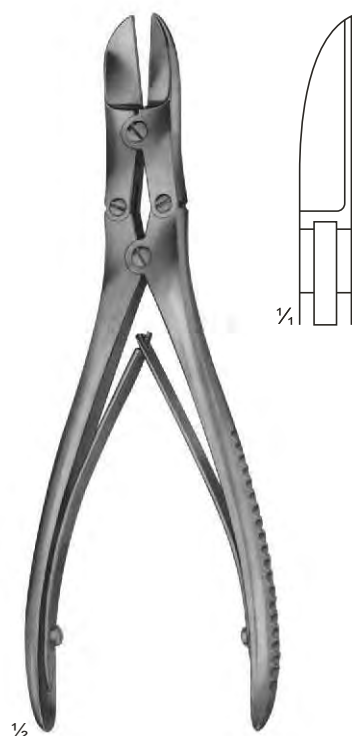

**22-188
RUSKIN-LISTON**
190 mm



**22-189
RUSKIN-LISTON**
190 mm

Bone Cutting Forceps

REALSTAR SURGICAL INSTRUMENTS

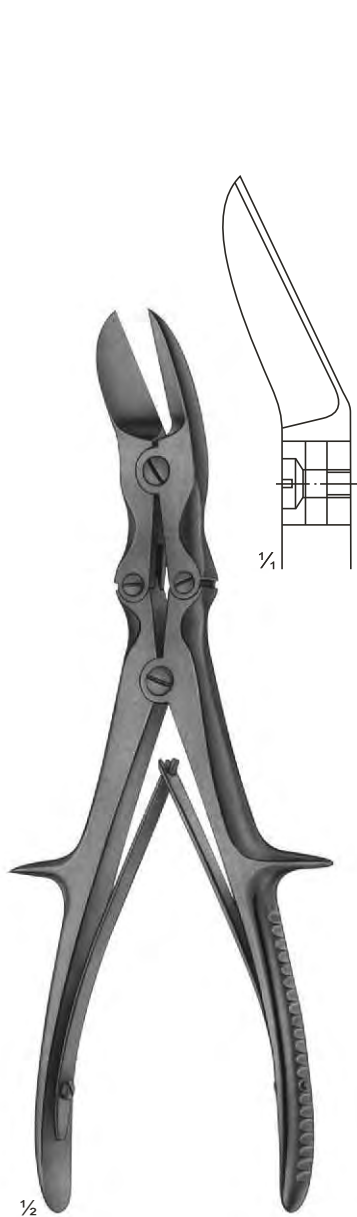

22-190
LISTON
curved on flat
240 mm

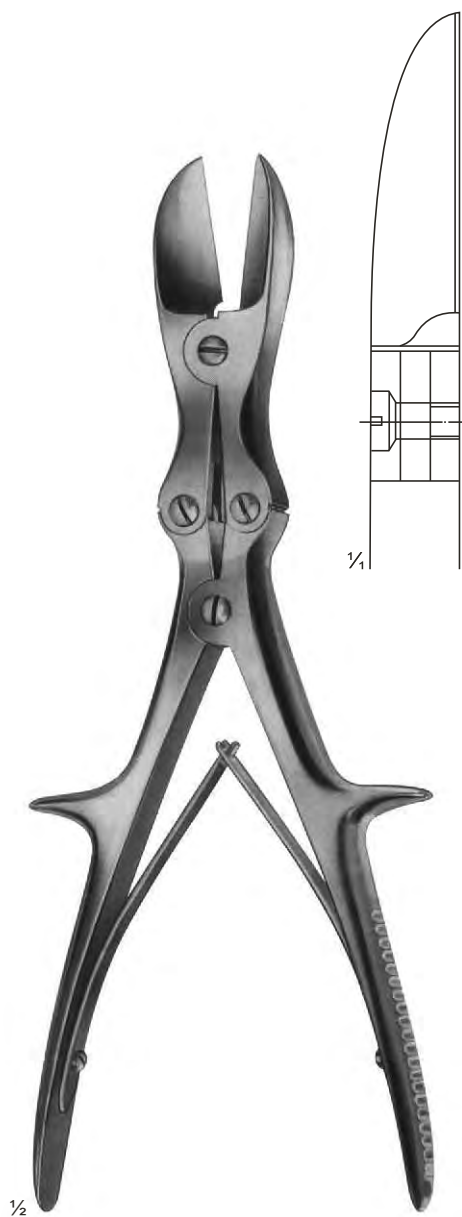

22-191
LISTON
straight
280 mm

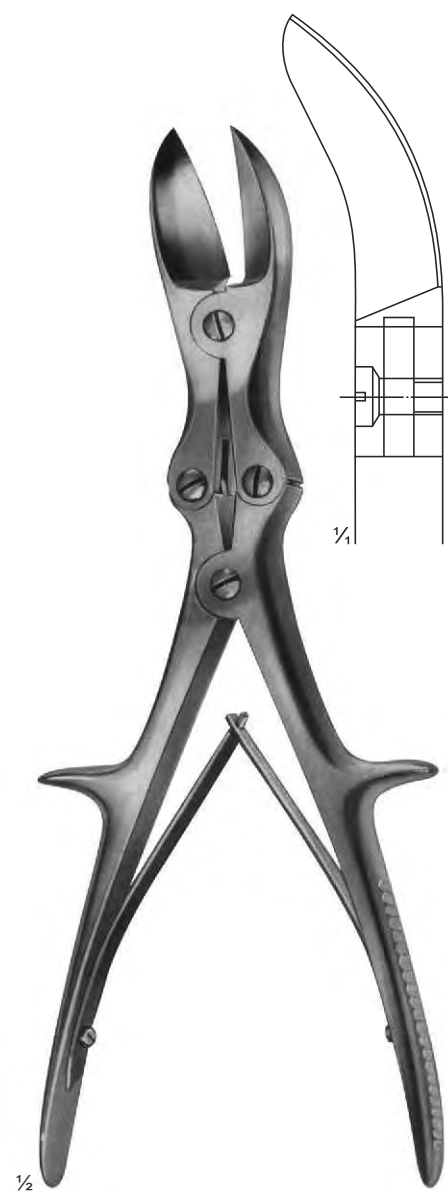

22-192
LISTON
curved on flat
280 mm

Bone Cutting Forceps

REALSTAR SURGICAL INSTRUMENTS

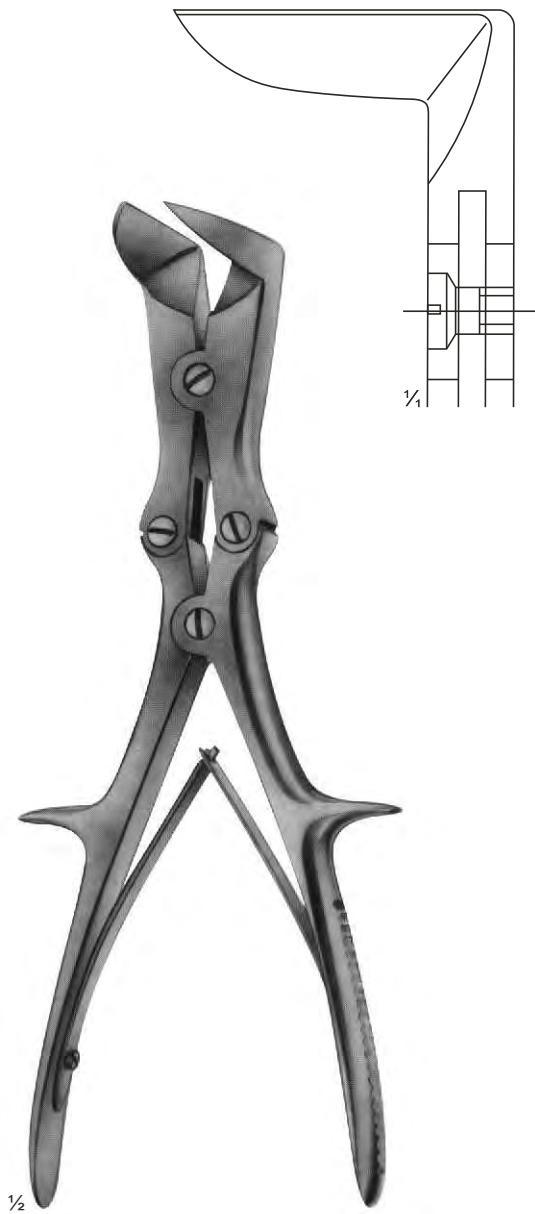

22-193
LISTON-STILLE
265 mm

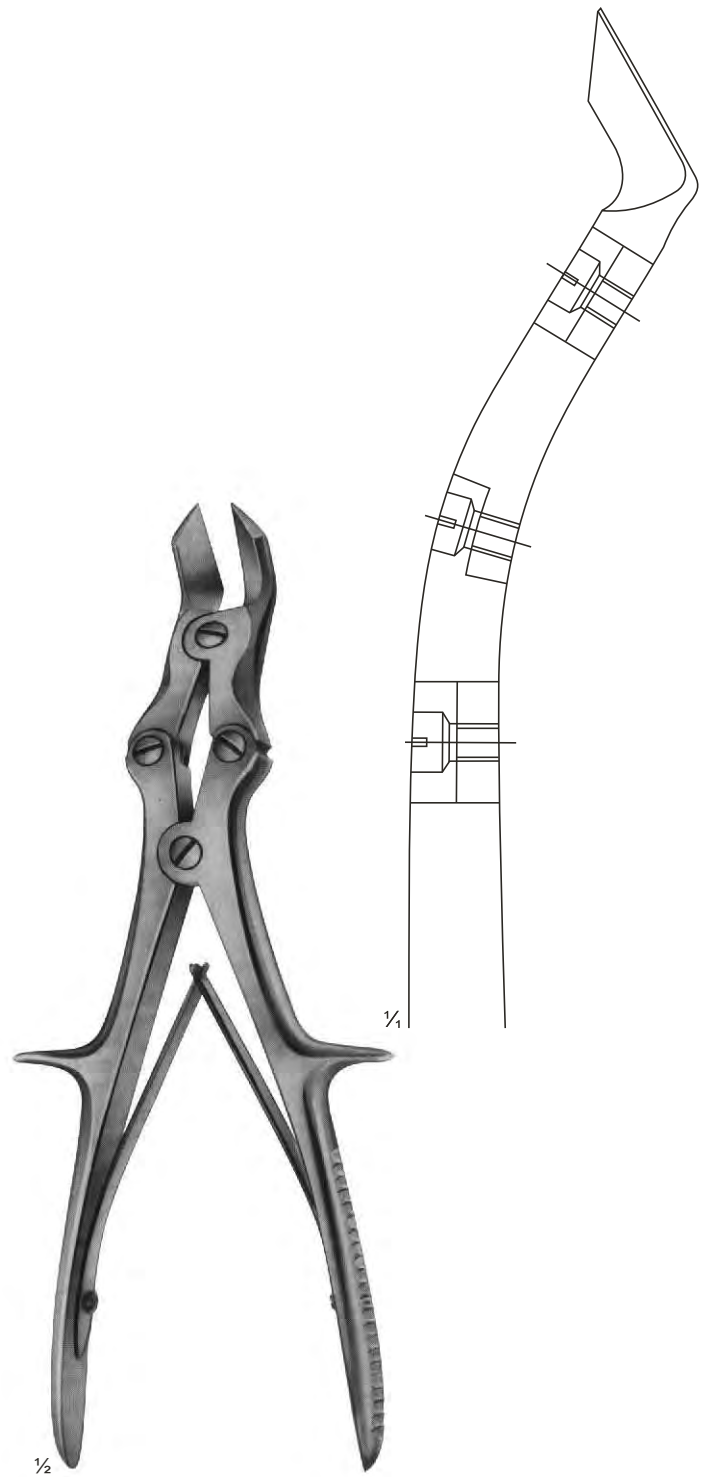

22-194
LISTON-KEY-HORSLEY
(TUDOR EDWARDS)
255 mm

Meniscus-and Cartilage Forceps

REALSTAR SURGICAL INSTRUMENTS



22-195
BIRCHER
200 mm



22-196
BIRCHER
200 mm



22-197
WELLER
200 mm

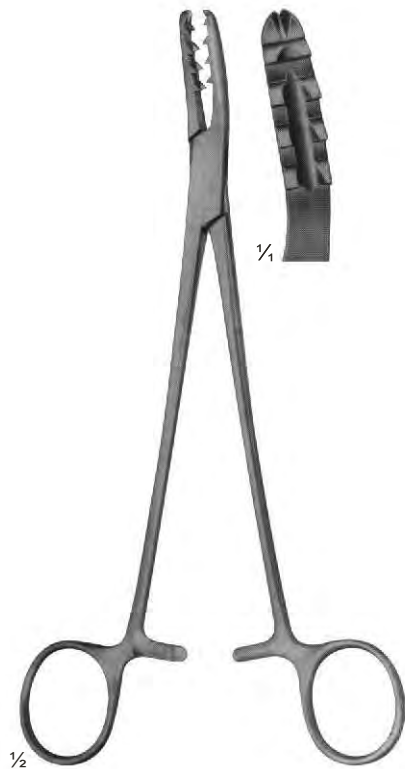

22-198
BIRCHER-GANSKE
200 mm

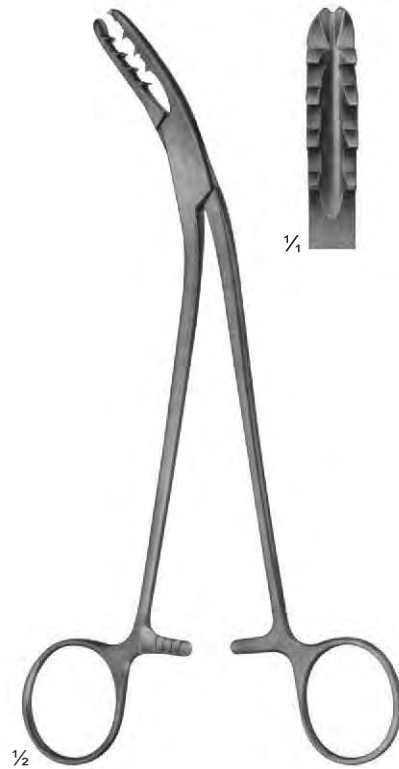

22-199
BIRCHER-GANSKE
200 mm



22-200
MARTIN
205 mm

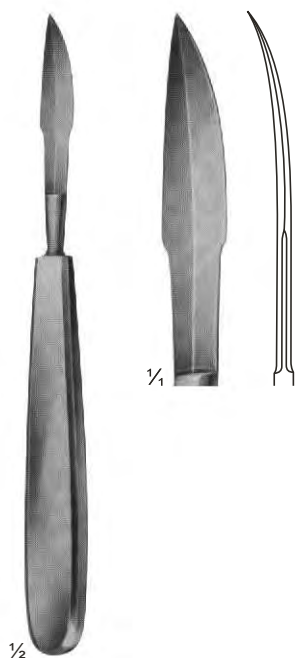

22-201
170 mm

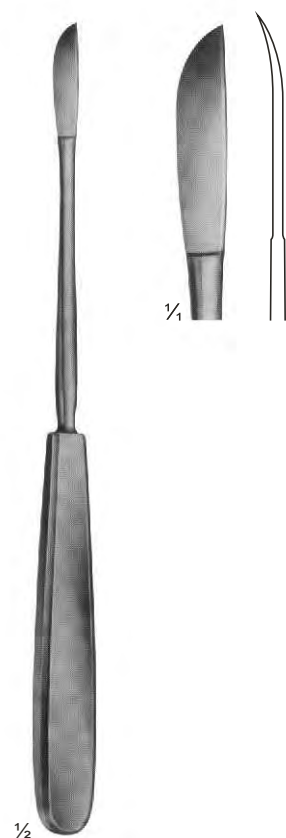

22-202
NEFF
215 mm



22-203
NEFF
215 mm



22-204
WAGNER
215 mm

Meniscus Knives

REALSTAR SURGICAL INSTRUMENTS

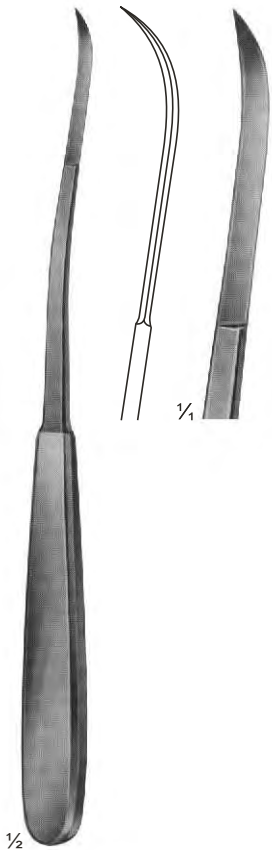

22-205
SALENIUS
220 mm

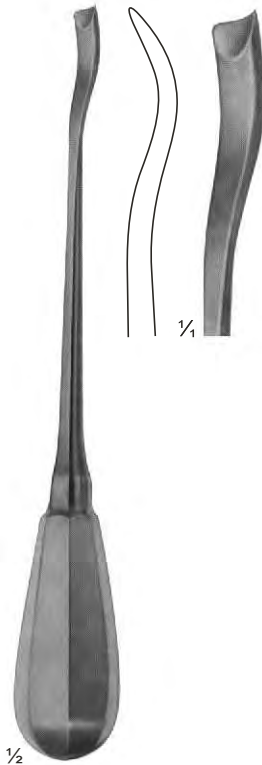

22-206
CHNAD.MODELL
200 mm

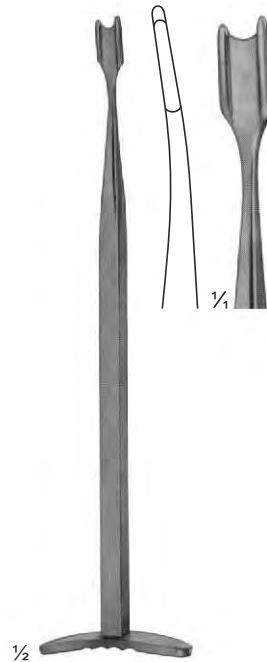

22-207
SMILLIE
170 mm

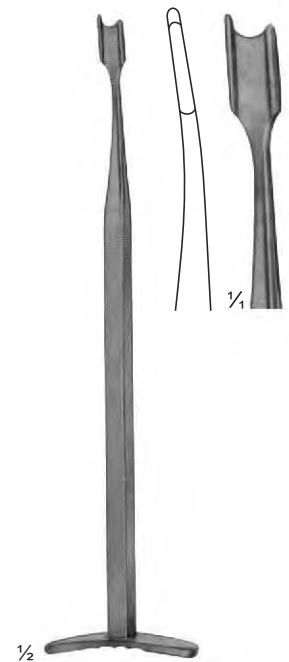

22-208
SMILLIE
170 mm

Wire Extension

REALSTAR SURGICAL INSTRUMENTS

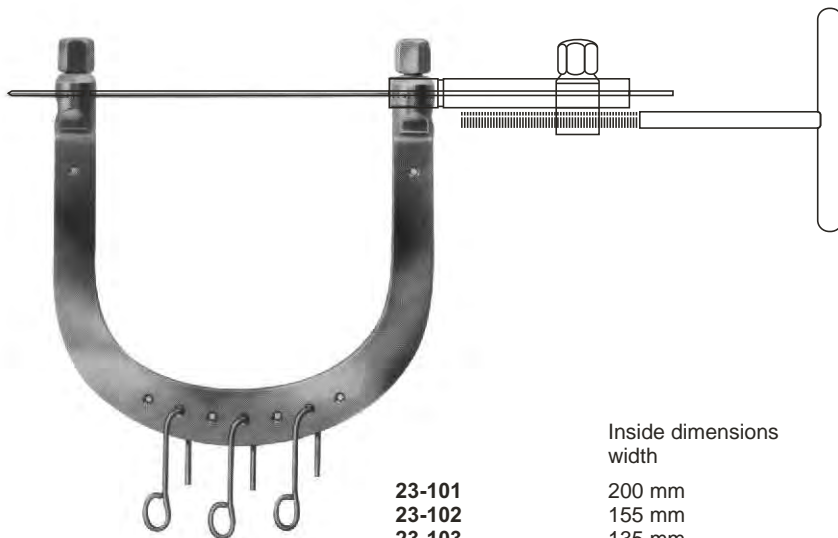

23-101 - 107
KIRSCHNER
Wire traction bows,
to be used with
KIRSCHNER-wires
up to 2.5 mm diam.,
With 3 hooks,
stainless steel

- 23-101
- 23-102
- 23-103
- 23-104
- 23-105
- 23-106
- 23-107

Inside dimensions	width	depth
23-101	200 mm	155 mm
23-102	155 mm	155 mm
23-103	135 mm	130 mm
23-104	120 mm	120 mm
23-105	105 mm	100 mm
23-106	95 mm	110 mm
23-107	95 mm	70 mm



23-108
Wrench, double - ended,
for wire traction bows



23-109
Wire tightener, with
clamping jaws



23-110
Traction hook only,
large size



23-111
Traction hook only,
small size



23-112
Fixation clamp, to secure clamping
jaws of stainless steel

Wire Extension

REALSTAR SURGICAL INSTRUMENTS

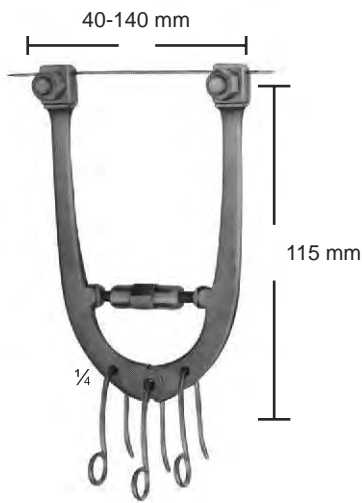

23-113
Wire traction bow, adjustable, with 3 hooks, small size

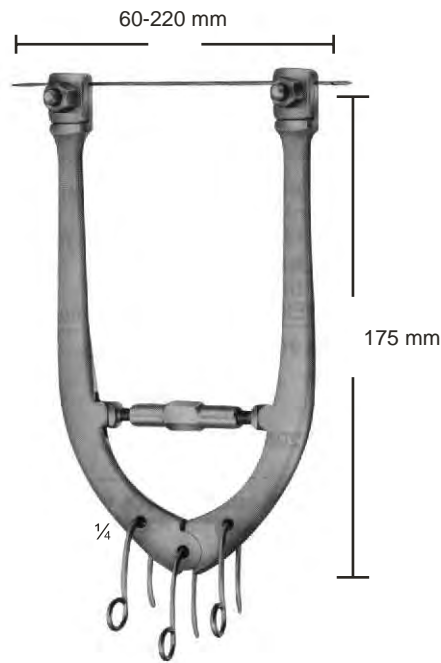

23-114
Wire traction bow, adjustable, with 3 hooks, large size

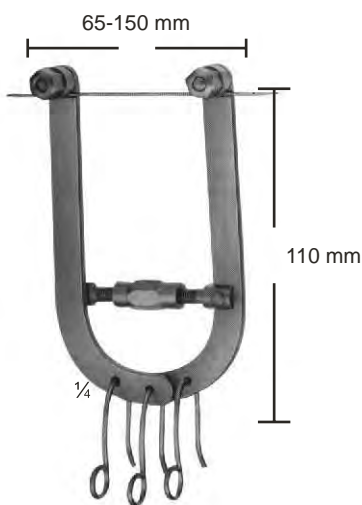

23-115
Wire traction bow, adjustable, with 3 hooks, large size for elbow and calcaneus, for adolescents



23-116 - 118
KIRSCHNER
Wire traction bow, modified adjustable in with width, holds wire securely, with 1 hook



23-119
Fixation disc, slotted



23-121
Fixation disc, slotted



23-120
idem, aluminum, transparent to X-rays



23-122
Screw driver, for above fixations discs

Traction Bows, Distractor

REALSTAR SURGICAL INSTRUMENTS



23-123 - 130
Screw driver, for above fixation discs

Steinmann pins, 4 mm daim.		Steinmann pins, 5 mm daim.	
23-123	with pin		16x9cm Arm
23-124	without pin	23-129	without
23-125	with pin		21x11cm Arm
23-126	without pin	23-130	without
23-127	with pin		21x15cm Arm
23-128	without pin		



23-131
SCHWARZ
Traction bow for fingers,
to be used with KIRSCHNER-
wire up to 1.6 mm diam.

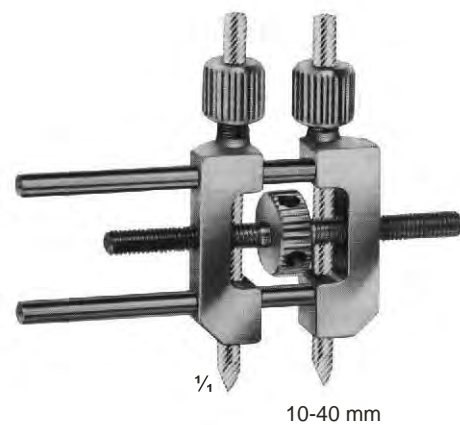

23-132
Small distractor
as a repositioning device for
distraction and compression of small bones,
for wires with 3.0 mm diam.

STEINMANN Pins

REALSTAR SURGICAL INSTRUMENTS



23-133 - 147
STEINMANN
triangular shaft ended and trocar point

Length	4,0 mm	5,0 mm
80 mm	23-133	
100 mm	23-134	
120 mm	23-135	
140 mm	23-136	
150 mm	23-137	23-143
160 mm	23-138	
180 mm	23-139	23-144
200 mm	23-140	23-145
210 mm	23-141	
250 mm	23-142	23-146
300 mm		23-147



1/4

23-148
Protection cap
for 4,0 mm STEINMANN Pins



1/4

23-149
Protection cap
for 5,0 mm STEINMANN Pins

Drilling Chucks

REALSTAR SURGICAL INSTRUMENTS



1/2

23-150
REILL
Drilling chuck, cannulated, for shanks from 2.0 - 2.5 mm diam 115 mm



1/2

23-151
Drilling chuck, cannulated, for shanks from 0.8 - 2.0 mm diam 150 mm



1/2

23-152
Drilling chuck, cannulated, for shanks up to 4.5 mm diam with key 140 mm



1/2

23-153
LOUTE
Wire tightener, improved pattern, with movable tip, for wires up to 1.0 mm diam. 220 mm



1/2

23-154
Drilling chuck, cannulated, for shanks up to 6.35 mm diam., To be tightened by hand 100 mm



1/2

23-155
Drilling chuck, cannulated, for shanks up to 4.5 mm diam., And for triangular shaft width across flats 4.7 mm



1/2

23-156
Drilling chuck, cannulated, for shanks up to 6.35 mm diam., With key 160 mm

Cerclage Instruments

REALSTAR SURGICAL INSTRUMENTS

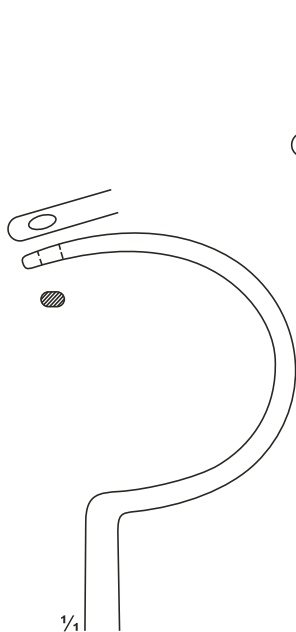

23-157
275 mm

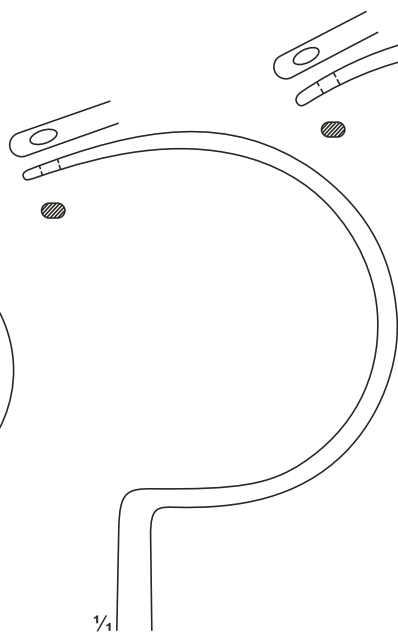

23-158
285 mm

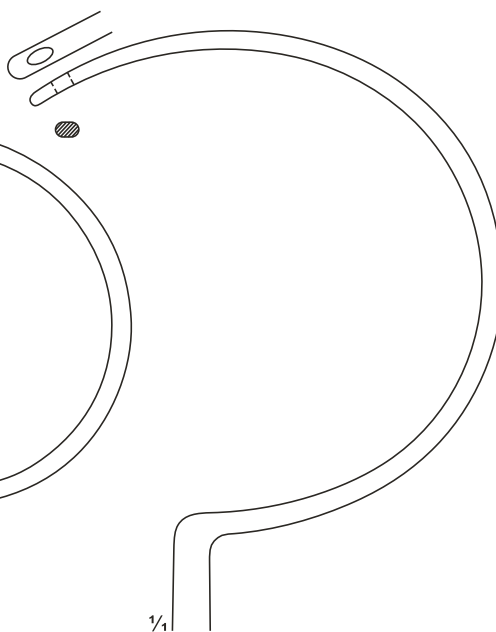

23-159
305 mm



23-157 - 159
DEMEL
Wire guides

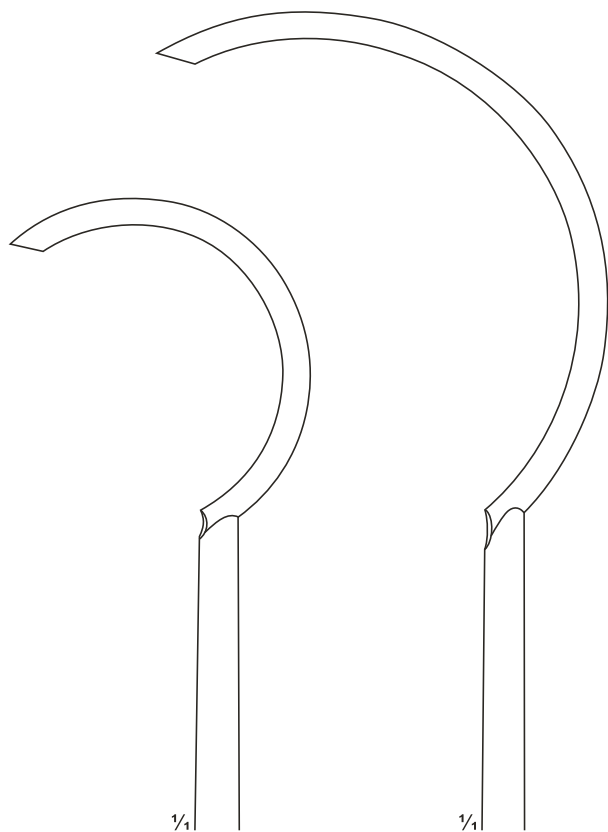

23-160
240 mm



23-161
270 mm

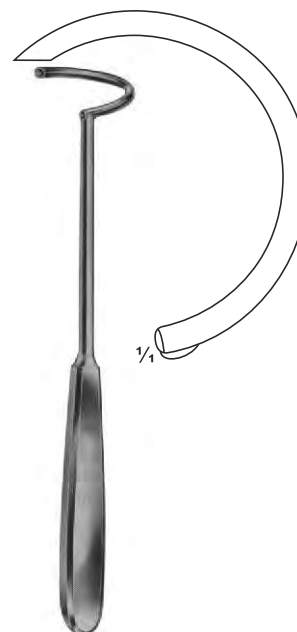

23-162
225 mm

**JORDAN instruments for subcutaneous
Tibia Cerclage**

**REALSTAR SURGICAL
INSTRUMENTS**



23-163
JORDAN
Wire tightener



$\frac{1}{2}$
23-164
JORDAN
Wire twister
170 mm



$\frac{1}{2}$
23-165
JORDAN
Wire catcher
180 mm



$\frac{1}{2}$
23-166
JORDAN
Probe, cannulated
170 mm

Wire Holding forceps, Wire Tightening Pliers, Flat-nosed Pliers

REALSTAR SURGICAL INSTRUMENTS

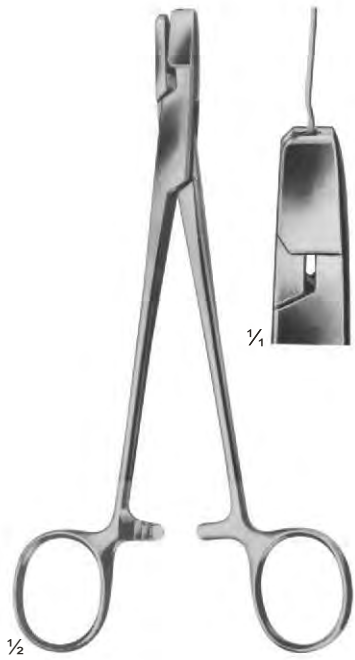

23-167
DUROGRIP
Holding forceps for cerclage wire, with lateral jaws to avoid wire slipping off
170 mm



23-168
DUROGRIP
Wire, tightening pliers, Ligature pliers
150 mm



23-169
DUROGRIP
Wire, tightening pliers, Ligature pliers
150 mm



23-170
with serrated jaws
140 mm



23-171
one jaws smooth, one jaws serrated
140 mm



23-172
with serrated jaws



23-173
with longitudinal and transversal grooves
170 mm



23-174
190 mm

Wire Holding forceps, Flat-nosed Pliers,
Pliers for bending and cutting wires

REALSTAR SURGICAL
INSTRUMENTS



23-175 - 176
Extraction pliers
for boring wires

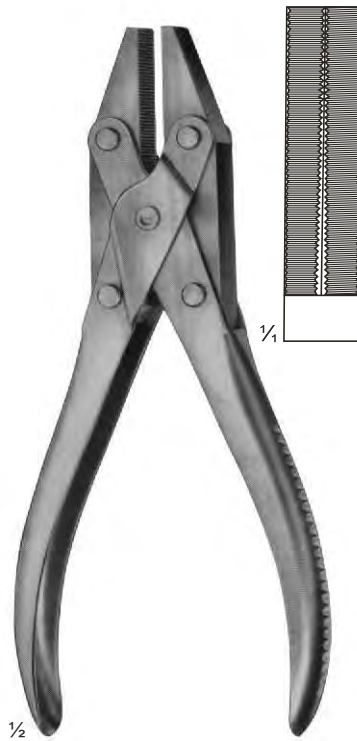

23-177
Flat-nosed pliers,
parallel
185 mm

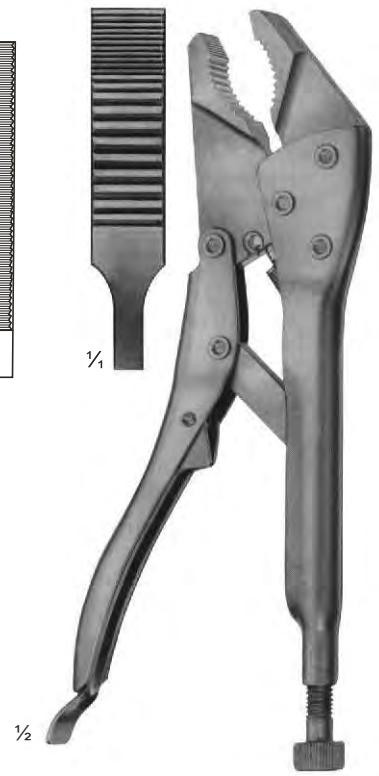

23-178
Vise grip
200 mm

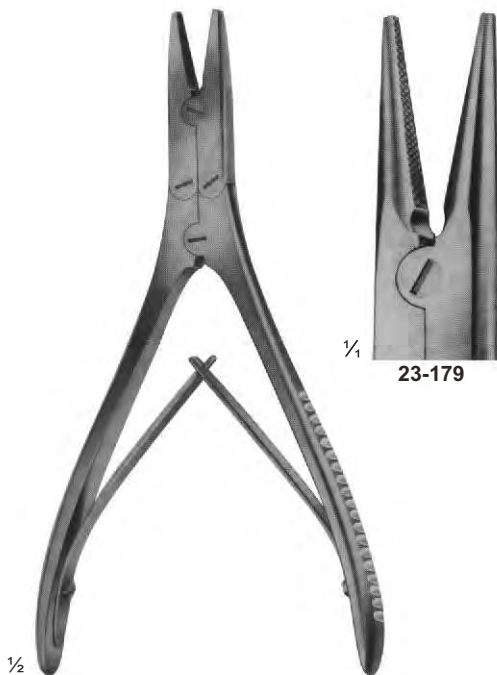

23-179 - 183
Round pliers
180 mm

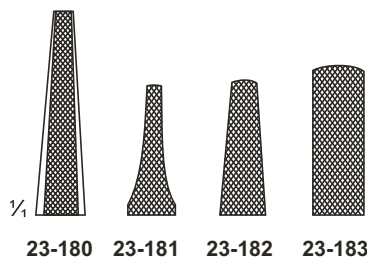

23-180
23-181 145 mm
23-182 180 mm
23-183 180 mm
Extraction pliers for wires



23-184
Bending pliers
for wires up to
1.8 mm diam.

Wire Cutters and wire Cutting Scissors

REALSTAR SURGICAL INSTRUMENTS



23-185
ANGLE
130 mm

for soft wire
up to diam.
for hard wire
up to diam.

23-186
DUROTIP
ANGLE
130 mm

0,5 mm 0,6 mm
0,3 mm 0,4 mm

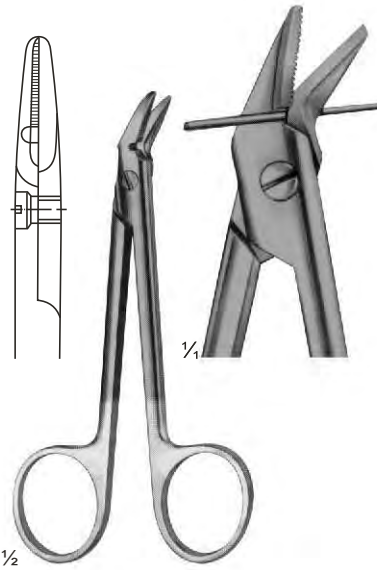

23-187
120 mm

for soft wire
up to diam.
for hard wire
up to diam.

23-188
DUROTIP
120 mm

1,2 mm 1,2 mm
0,8 mm 0,8 mm

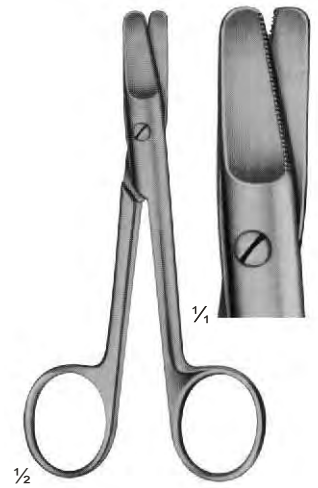

23-189
HARVEY
125 mm

0,4 mm
0,3 mm



23-190
150 mm

for soft wire
up to diam
for hard wire
up to diam

1,5 mm
1,0 mm



23-191
160 mm

1,5 mm
1,2 mm



23-192
140 mm

1,5 mm
1,0 mm

Wire Cutting Pliers, Lateral Cutting Action

**REALSTAR SURGICAL
INSTRUMENTS**



23-193
180 mm

for soft wire
up to diam. 2,0 mm
For hard wire
up to diam 1,5 mm
specially hardened
cutting edges, front
and lateral cutting
action



23-194
REILL
175 mm

for soft wire
up to diam. 2,0 mm
For hard wire
up to diam 1,6 mm
specially hardened
cutting edges, for
cutting off wires close
to the bone



23-195
235 mm

for soft wire
up to diam. 3,0 mm
For hard wire
up to diam 2,2 mm

**REALSTAR SURGICAL
INSTRUMENTS**

SERVING TO SAVE LIVES

389

Gali Shah Khaki Wali Kashmir Street,
Rang Pura Road, Sialkot 51310-Pakistan
Phone: +92 3348033729
Fax: +92 52 4570067
E-mail: info@Realstarsurgical.com
Website: www.Realstarsurgical.com

Wire Cutting Pliers, Lateral and Front Cutting Action

REALSTAR SURGICAL INSTRUMENTS



23-196
240 mm

for soft wire up to diam. 2,0 mm
For hard wire up to diam 1,6 mm



23-197
140 mm

for soft wire up to diam. 1,5 mm
For hard wire up to diam 1,0 mm

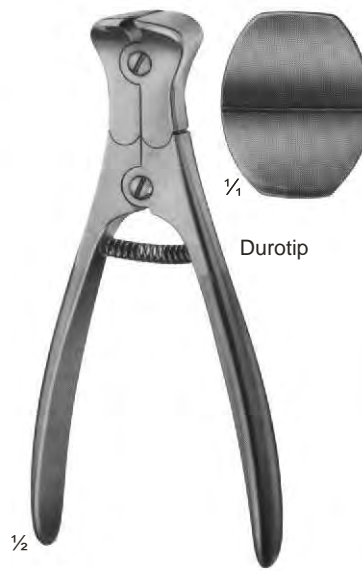

23-198
145 mm

for soft wire up to diam. 2,0 mm
For hard wire up to diam 1,5 mm



23-199
220 mm

for soft wire up to diam. 3,5 mm
For hard wire up to diam 2,5 mm

Wire Cutting Pliers

REALSTAR SURGICAL INSTRUMENTS



Cutter for cutting off
KIRSCHNER wires,
Tibia head screws,
bolts, pins, up to 3 mm diam.

1/2

23-200
320 mm

for soft wire up to diam. 3,0 mm
For hard wire up to diam 3,0 mm



Durotip

23-201
Cutter for cutting off
KIRSCHNER wires,
Tibia head screws,
bolts, pins, up to 6 mm diam.
470 mm

Finger Nail Instruments

REALSTAR SURGICAL INSTRUMENTS

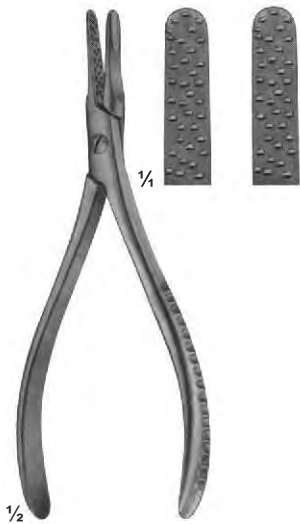

23-202
Nail extracting
forceps
135 mm



23-203
Nail extracting
forceps
145 mm

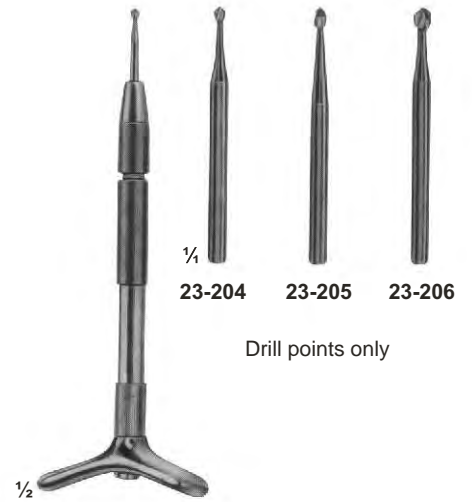

23-204 - 206
Finger nail drill
with 3 points

Drill points only

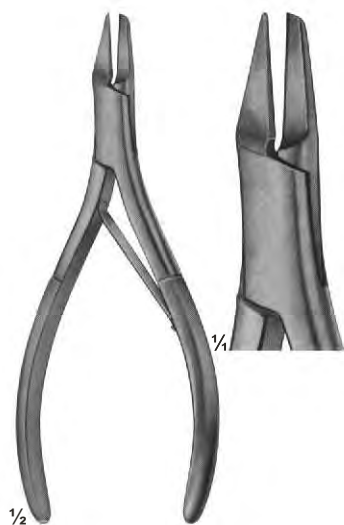

23-207
Nail splitting
forceps
135 mm

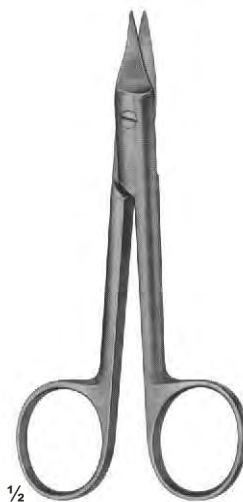

23-208
SYSTRUNK
Scissors, for splitting
finger nails
130 mm



23-209
Finger ring saw
150 mm

Spare blade

Plaster Instruments

REALSTAR SURGICAL INSTRUMENTS



with ebony handle

24-101
HOPKINS
200 mm



1/2

24-102
ESMARCH
180 mm



1/2

24-103
ENGEL
160 mm

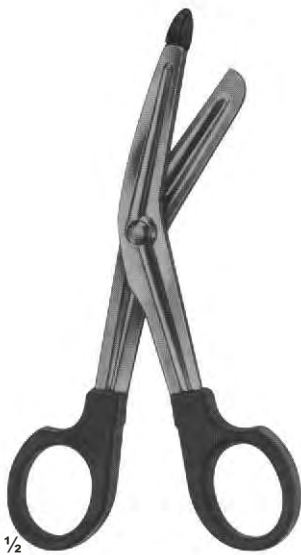

1/2

24-104 - 112

- | | | | |
|--------|-------|--------|-------------|
| 24-104 | black | 24-108 | yellow |
| 24-105 | red | 24-109 | white |
| 24-106 | blue | 24-110 | orange |
| 24-107 | green | 24-111 | lavender |
| | | 24-112 | bright pink |



1/2

24-113 - 121

- | | | | |
|--------|-------|--------|-------------|
| 24-113 | black | 24-117 | yellow |
| 24-114 | red | 24-118 | white |
| 24-115 | blue | 24-119 | orange |
| 24-116 | green | 24-120 | lavender |
| | | 24-121 | bright pink |

Plaster Scissors

REALSTAR SURGICAL INSTRUMENTS

For small plaster dressings



Plaster Shears

REALSTAR SURGICAL INSTRUMENTS



24-129
STILLE-AESCULAP
260 mm



24-130
STILLE-AESCULAP
360 mm

STILLE Plaster Shears

REALSTAR SURGICAL INSTRUMENTS

Blade with reinforced back



24-131
STILLE
230 mm

24-132
Spare blade



24-133
STILLE
370 mm

24-134
Spare blade



24-135
STILLE
240 mm

24-136
Spare blade

Plaster Spreader, Plaster Breakers

REALSTAR SURGICAL INSTRUMENTS



24-137
HENING
270 mm



24-138
MOD.USA
230 mm



24-139
290 mm



with removable jaws



24-140 - 141
WOLFF
24-140 180 mm
24-141 240 mm

Vacuum Currettes for Aspiration Lipectomy, Suction Instruments

REALSTAR SURGICAL INSTRUMENTS

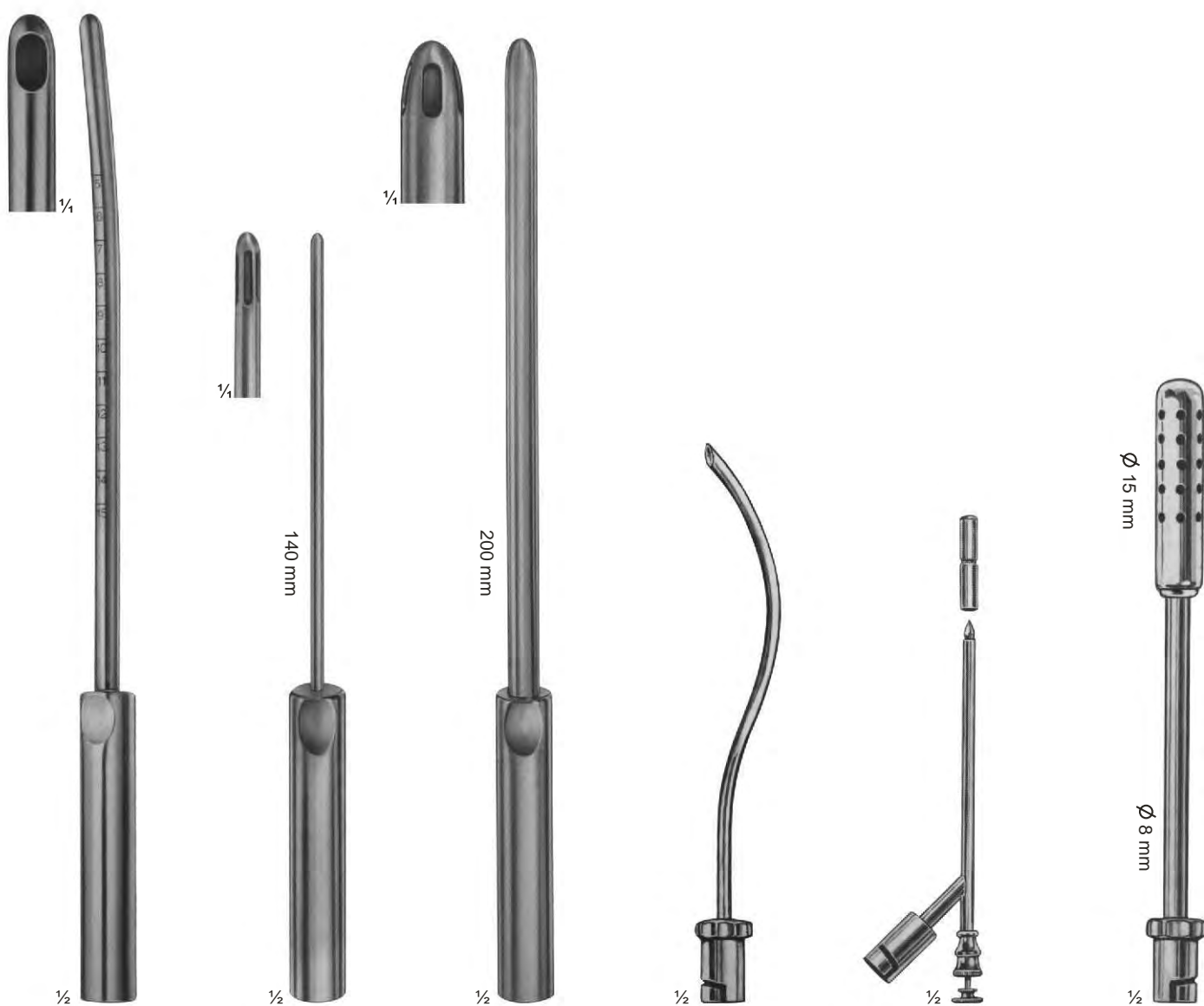

25-101 - 106

BIEMER

25-101 ø 4 mm

25-102 ø 6 mm

25-103 ø 8 mm

25-104 ø 10 mm

25-105 ø 12 mm

25-106 ø 14 mm

Currettes for aspiration lipectomy, graduated, slightly curved

25-107 - 108

BIEMER

25-107 ø 4 mm

25-108 ø 6 mm

Currettes for aspiration lipectomy, with three apertures, slightly curved malleable

25-109 - 111

BIEMER

25-109 ø 8 mm

25-110 ø 10 mm

25-111 ø 12 mm

Currettes for aspiration lipectomy, with three apertures, slightly curved malleable

25-112

For aspirating fluid from the excretory ducts of large glands and for keeping the operating area clear 170 mm

25-113

Trocar

For puncturing 150 mm

25-114

For clearing large quantities of fluid 190 mm

Suction Instruments

REALSTAR SURGICAL INSTRUMENTS



25-115
Trocar
For puncturing
170 mm



25-116
Hollow needle,
sharp
150 mm



25-117
double curved
For general
surgery
230 mm



25-118
For tonsillectomy,
oral and laryngeal
operations
190 mm



25-119
For tonsillectomy,
oral and laryngeal
operations
220 mm

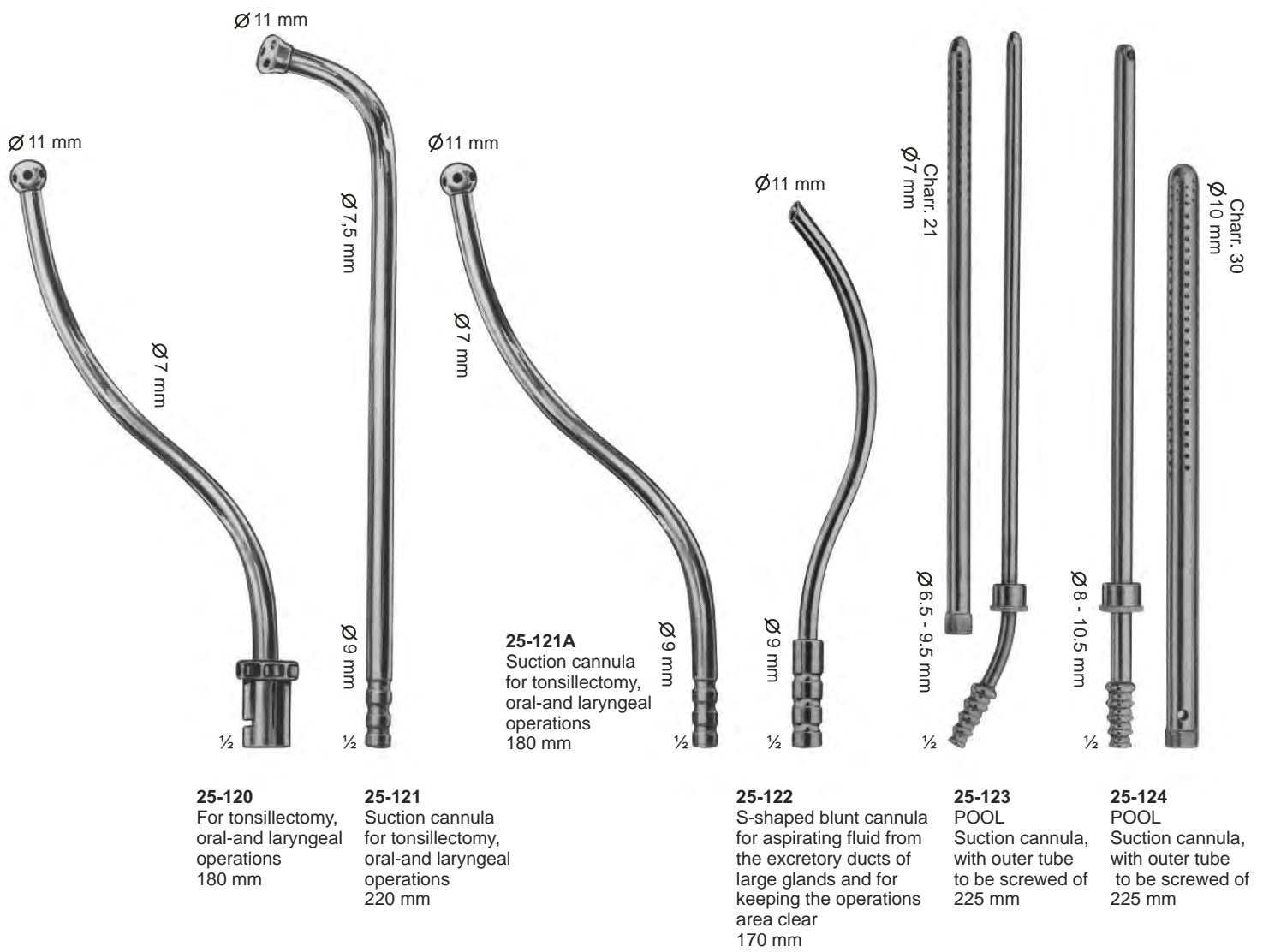

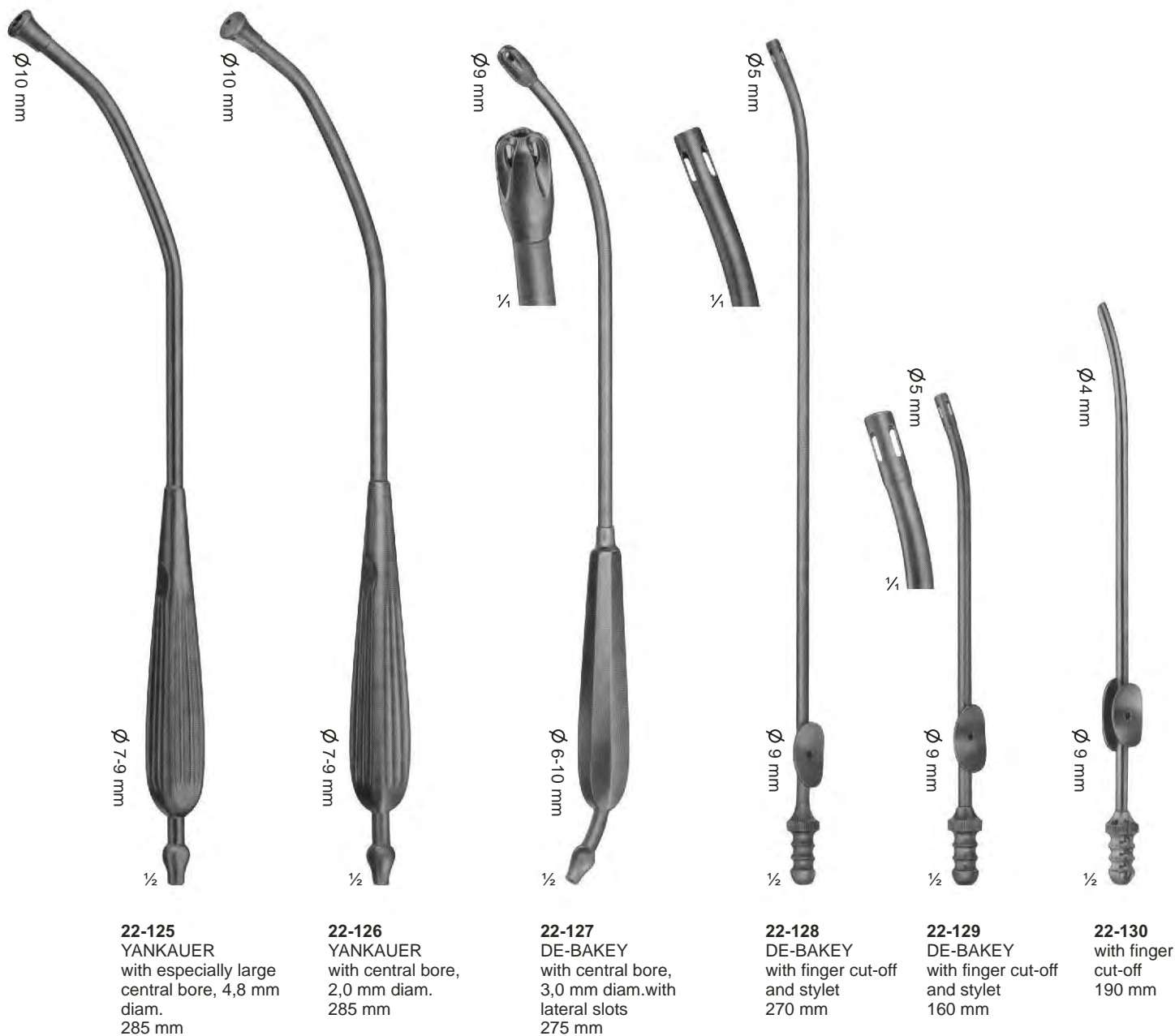

Suction Instruments

REALSTAR SURGICAL INSTRUMENTS



∅ 6-9 mm

1/2

- 25-131 ∅ 1,5 mm
- 25-132 ∅ 2,0 mm
- 25-133 ∅ 2,5 mm
- 25-134 ∅ 3,0 mm

25-131 - 134
PLESTER
 with finger cut-off and
 stylet, thumb piece
 parallel to curved, with
 LUER hub
 195 mm



∅ 6-9 mm

1/2

- 25-135 ∅ 2,0 mm
- 25-136 ∅ 2,5 mm
- 25-137 ∅ 3,0 mm
- 25-138 ∅ 4,0 mm
- 25-139 ∅ 5,0 mm

25-135 - 139
FERGUSSON
 with finger cut-off and
 stylet, thumb piece
 90° to curved, with
 LUER hub
 180 mm



∅ 6-9 mm

1/2

25-140 ∅ 4,0 mm
FERGUSSON
 insulated, with finger cut-off
 and stylet, thumb piece 90°
 to curved, with LUER hub
 180 mm



∅ 6-9 mm

1/2

25-141 ∅ 3,0 mm
25-142 ∅ 5,0 mm
FRAZIER
 insulated, with finger
 cut-off and stylet, thumb
 piece 90° to curved,
 with LUER hub
 180 mm

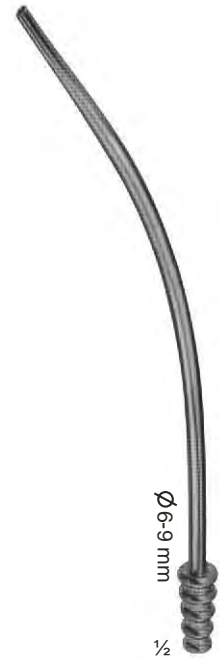

∅ 6-9 mm

1/2

25-143
 5,0 mm diam., Tip
 6,5 mm wide, Nasal
 suction tube, with
 LUER hub
 180 mm



1/2

25-144 ∅ 4,5 mm
25-145 ∅ 5,5 mm
 Nasal suction
 tubes
 175 mm



1/2

25-146
GORNEY
 Suction dissector
 180 mm



∅ 6-10 mm

1/2

25-147 4 mm wide
25-148 5 mm wide
 Suction raspatories,
 sharp, bayonet-shaped,
 with styelt
 200 mm



∅ 9 mm

1/2

25-149
LOPEZ-REINKE
 Tonsil dissector with
 suction device
 235 mm

Suction Instruments

REALSTAR SURGICAL INSTRUMENTS

25-150 WULLSTEIN
Suction tube, conical, silver, oliver
with LUER hub
160 mm

$\varnothing 1,75$ mm $\varnothing 3$ mm
 $\frac{1}{2}$
 $\varnothing 8$ mm

25-151 1,5 mm
25-152 2,0 mm
WULLSTEIN
Suction tube, cylindrical, silver, with
stylet with LUER hub
160 mm

$\frac{1}{2}$
 $\varnothing 8$ mm

Usable length

YASARGIL usable length diam.		YASARGIL usable length diam.	
25-153	130 mm 1,5 mm	25-161	130 mm 2,5 mm
25-154	150 mm 1,5 mm	25-162	150 mm 2,5 mm
25-155	180 mm 1,5 mm	25-163	180 mm 2,5 mm
25-156	220 mm 1,5 mm	25-164	220 mm 2,5 mm
25-157	130 mm 2,0 mm	25-165	130 mm 3,5 mm
25-158	150 mm 2,0 mm	25-166	150 mm 3,5 mm
25-159	180 mm 2,0 mm	25-167	180 mm 3,5 mm
25-160	220 mm 2,0 mm	25-168	220 mm 3,5 mm
		25-169	180 mm 4,5 mm

$\varnothing 6,5-9$ mm
with LUER hub

25-170 - 172 LANDOLT
150 MM
diam $\varnothing 3$ mm

25-170 8 mm / curved
25-171 11mm / curved
25-172 15mm / curved

$\frac{1}{2}$
 $\frac{1}{2}$

$\varnothing 3.5$ mm $\varnothing 2.0$ mm

25-173 500 mm
25-174 350 mm
with rubber tip,
with LUER hub

$\varnothing 9$ mm
 $\frac{1}{2}$

25-175 2,0 mm diam
25-176 2,5 mm diam
25-177 3,0 mm diam
with finger cut-off,
thumb piece 90° to
curved, with LUER hub
250 mm

$\varnothing 6-9$ mm
 $\frac{1}{2}$

Combined Suction and Irrigation Cannulae

REALSTAR SURGICAL INSTRUMENTS



25-179
YASARGIL
LURE-LOCK cone
200 mm

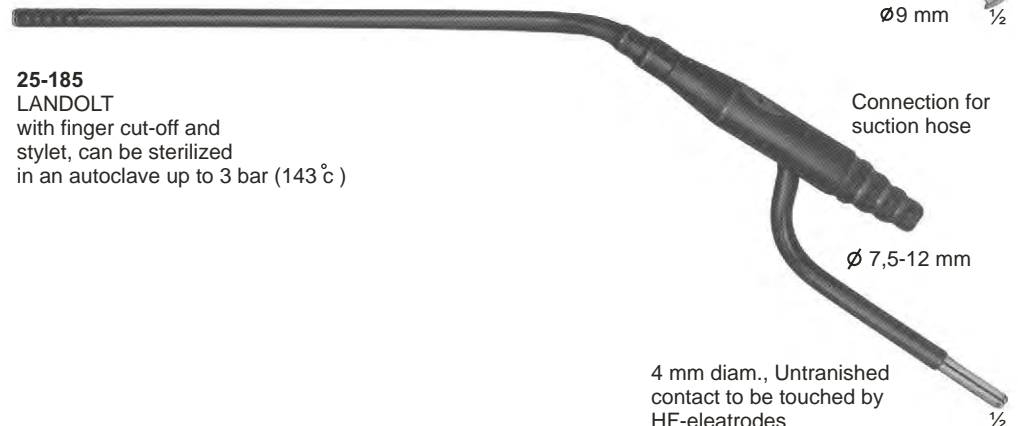
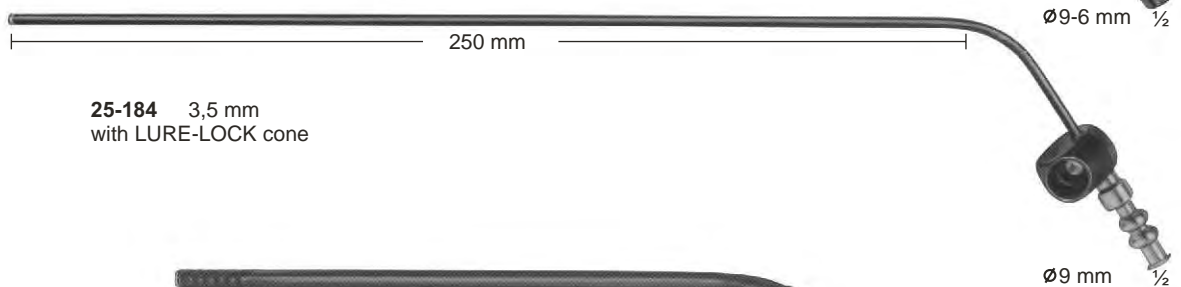
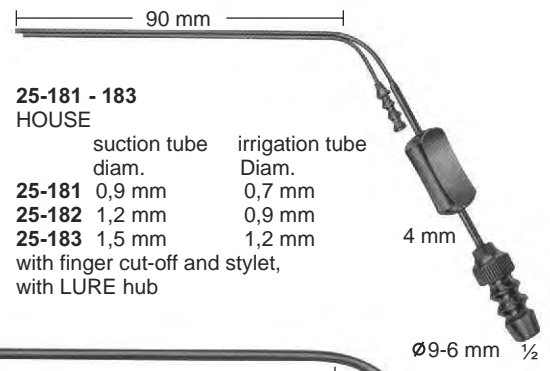
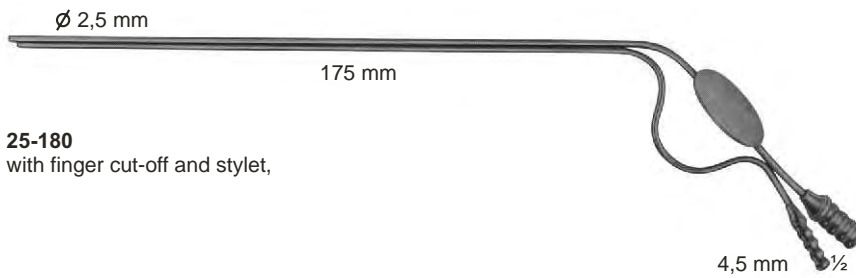

Scissors with Tungsten Carbide Inserts

REALSTAR SURGICAL INSTRUMENTS



26-101
Standard

14,5cm
16,5cm
18,5cm



26-102
Standard

14,5cm
16,5cm
18,5cm



26-103
Standard

14,5cm
16,5cm
18,5cm



26-104
Standard

14,5cm
16,5cm
18,5cm



26-105
Standard

14,5cm
16,5cm
18,5cm



26-106
Standard

14,5cm
16,5cm
18,5cm

Scissors with Tungsten Carbide Inserts

REALSTAR SURGICAL INSTRUMENTS



Scissors with Tungsten Carbide Inserts

REALSTAR SURGICAL INSTRUMENTS



Scissors with Tungsten Carbide Inserts

REALSTAR SURGICAL INSTRUMENTS

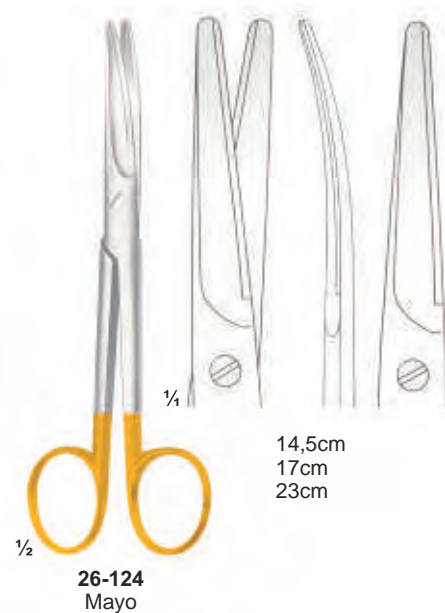
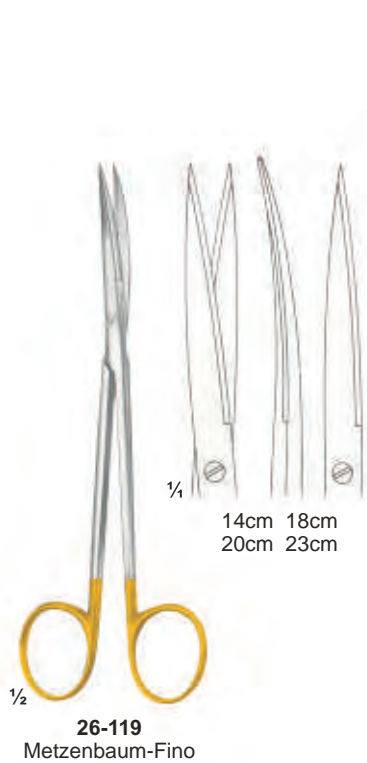

Scissors with Tungsten Carbide Inserts

REALSTAR SURGICAL INSTRUMENTS

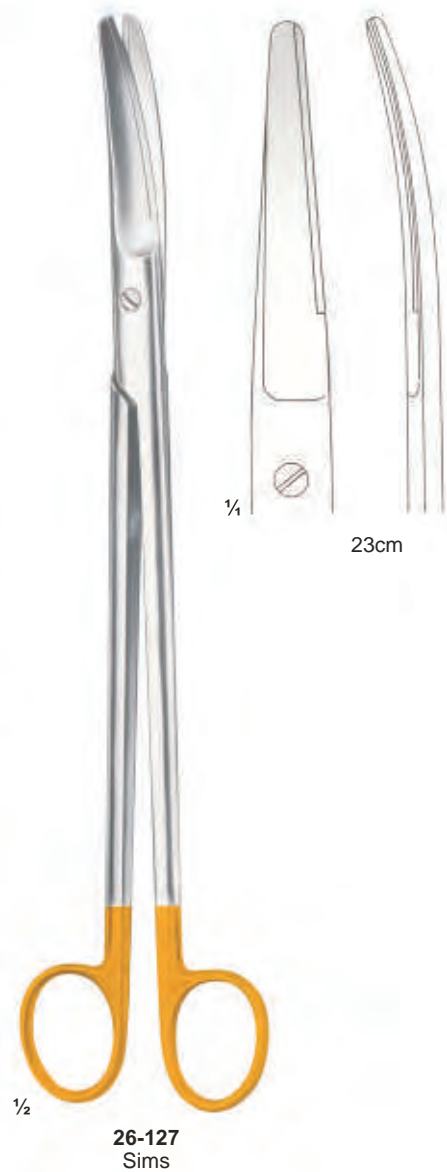
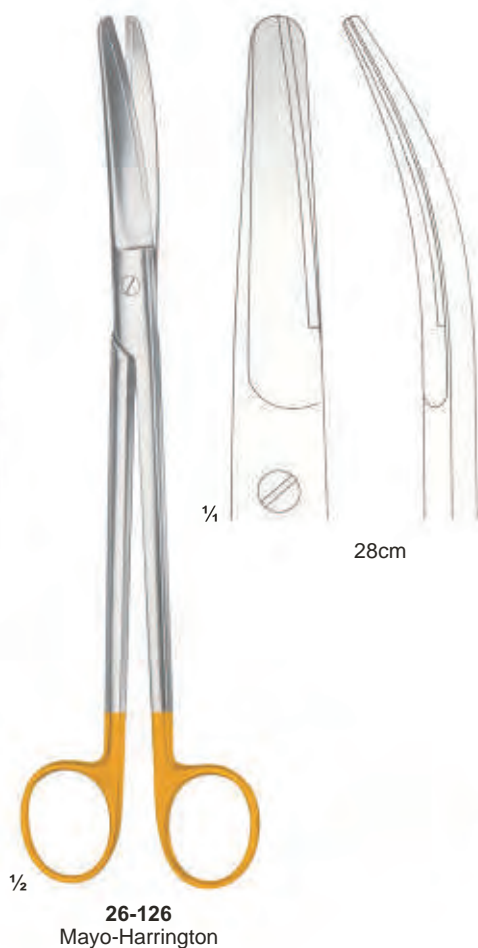

Scissors with Tungsten Carbide Inserts

REALSTAR SURGICAL INSTRUMENTS

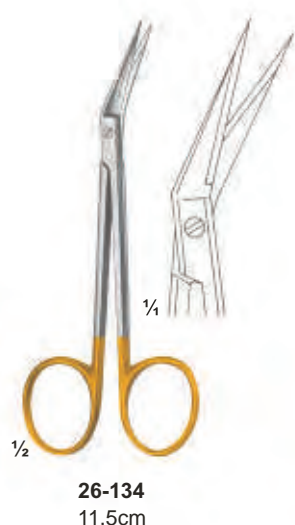
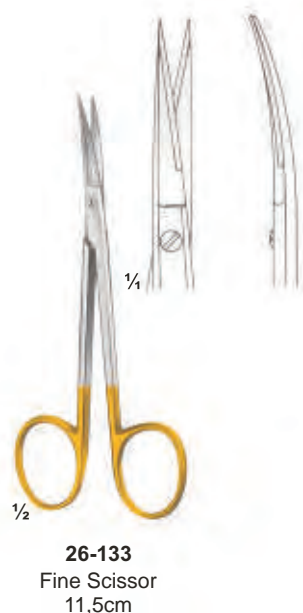
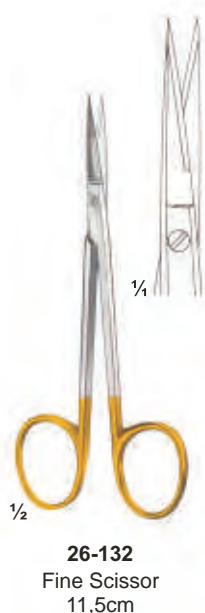
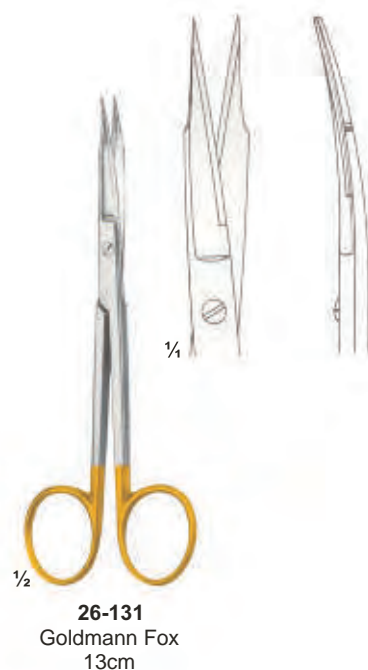
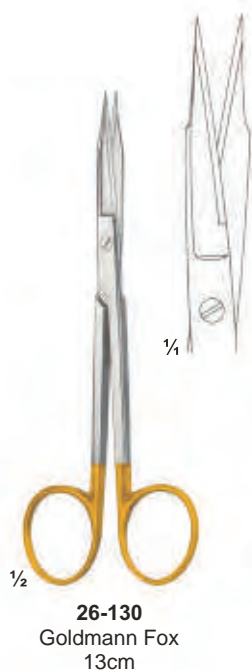

Scissors & Dissecting Forceps with Tungsten Carbide Inserts

REALSTAR SURGICAL INSTRUMENTS

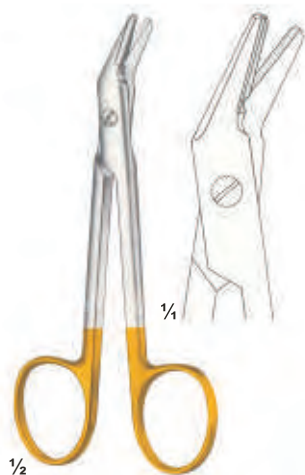

26-136
Universal
12cm



26-137
Ligature Scissors
1 Black & 1 Goldplated ring

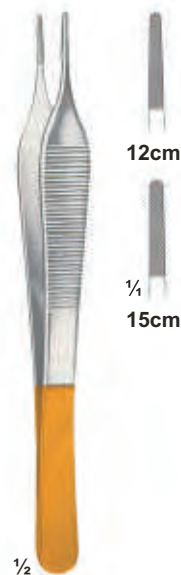

26-138
Adson



26-139
Cushing
17,5cm



26-140
Cushing
18cm



26-141
Cushing-Taylor
18cm



26-142
Dissecting Forceps
15cm



26-143
Semken
15cm

Dissecting Forceps and Needle holders with Tungsten Carbide Inserts

REALSTAR SURGICAL INSTRUMENTS



26-144
Wangenstein

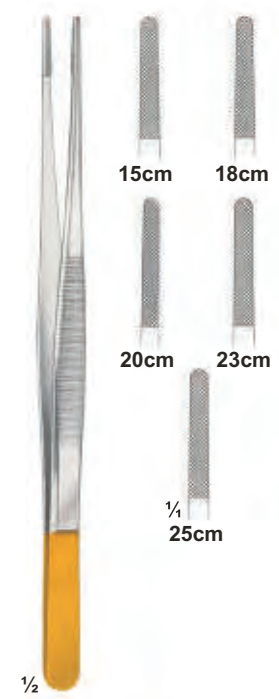

26-145
Potts-Smith

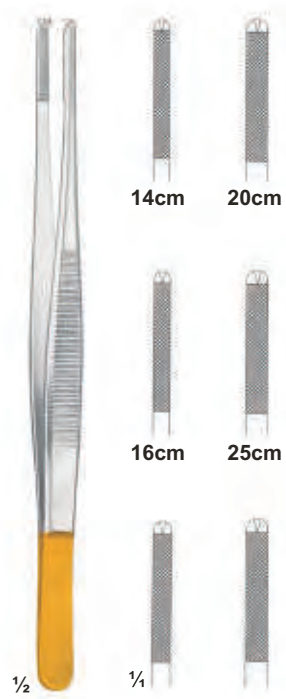

26-146
Oehler



26-147
Potts-Smith
22cm



26-148
Hepp-Scheidle
18cm



26-149
Castroviejo
14cm



26-150
Castroviejo
14cm



26-151
Arruga
16cm

Needle holders with Tungsten Carbide Inserts

REALSTAR SURGICAL INSTRUMENTS



26-152
Arruga
16cm



26-153
Castroviejo
13cm



26-154
Hegar
20cm 24cm

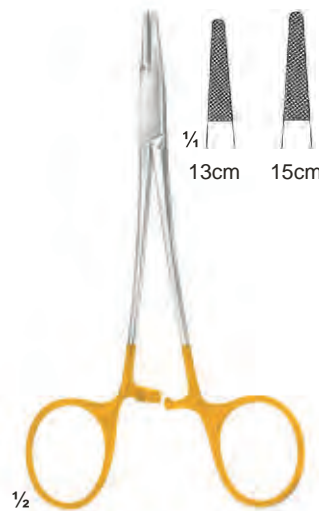

26-155
Halsey
13cm 15cm



26-156
Mayo-Hegar
16cm 18cm 20cm
24cm 26cm 30cm

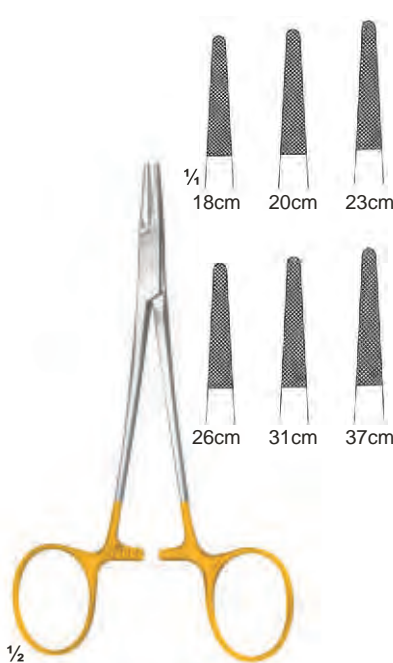

26-157
De-Bakey
18cm 20cm 23cm
26cm 31cm 37cm

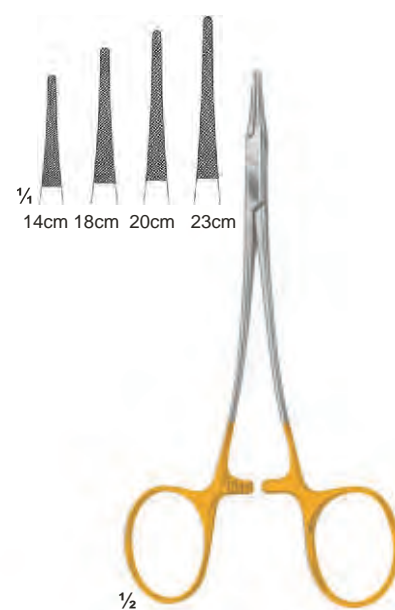

26-158
Hegar-Vascular
14cm 18cm
20cm 23cm

Needle holders with Tungsten Carbide Inserts

REALSTAR SURGICAL INSTRUMENTS



1/2
26-159
Bozemann-Wertheim
20cm 24cm 26cm

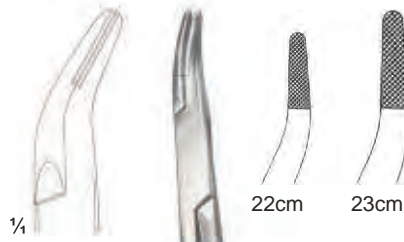

1/2
26-160
Stratte
22cm 23cm

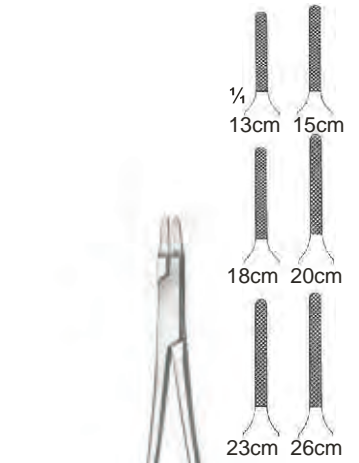

1/2
26-161
Ryder
13cm 15cm 18cm
20cm 23cm 26cm

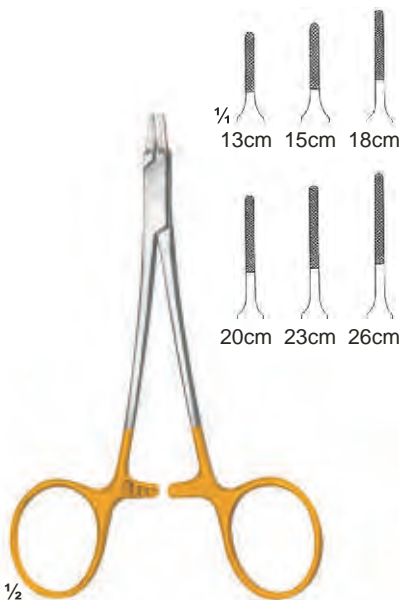

1/2
26-162
Ryder-Vascular
13cm 15cm 18cm
20cm 23cm 26cm



1/2
26-163
Martin
15cm 17cm 20cm



1/2
26-164
Sarot
18cm 20cm 26cm

Needle holders with Tungsten Carbide Inserts

REALSTAR SURGICAL INSTRUMENTS



Needle holders with Tungsten Carbide Inserts

REALSTAR SURGICAL INSTRUMENTS



1/2
26-172
 Mathieu-Ryder
 17cm
 20cm 24cm



1/2
26-173
 Lichtenberg
 20cm



1/2
26-174
 Langhals
 20cm 25cm



1/2
26-175
 Lichtenberg
 20cm 25cm



1/2
26-176
 Luehty-Beck
 20cm 25cm



1/2
26-177
 Luehty-Beck
 20cm 25cm



1/2
26-178
 Langebeck
 18cm
 20cm 23cm



1/2
26-179
 Langebeck-beck
 18cm
 20cm 23cm



27-101 - 115
Schimmelbusch

	Ø x H sizes in mm
27-101	80 x 80
27-102	105 x 120
27-103	140 x 140
27-104	160 x 120
27-105	160 x 150
27-106	190 x 150
27-107	190 x 190
27-108	240 x 160
27-109	240 x 240
27-110	290 x 160
27-111	290 x 240
27-112	340 x 160
27-113	340 x 340
27-114	390 x 190
27-115	390 x 290

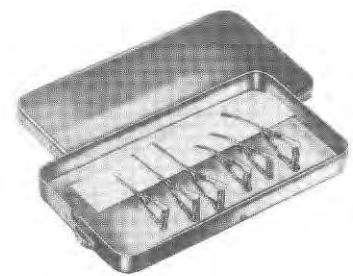

27-116
Box
120 x 65 x 13mm
(without Bulldog clamps,
without silicone tape)



27-117
Box with support
120 x 65 x 13 mm
(ohne Bulldogklemmen)



27-118
Box with support for
needle electrodes,
without instruments



27-119 - 121
50 x 25 x 4,5 mm
27-120
65 x 42 x 8 mm
27-121
75 x 25 x 4,5 mm

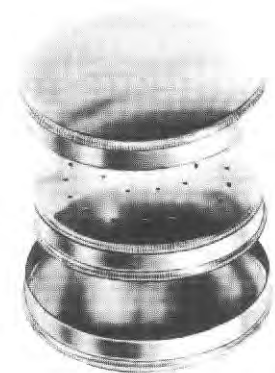

27-122
Ø 65mm x 15mm



27-123 - 131

	Ø x H
27-123	30 x 90 mm
27-124	50 x 100 mm
27-125	50 x 130 mm
27-126	50 x 175 mm
27-127	75 x 100 mm
27-128	75 x 130 mm
27-129	75 x 175 mm
27-130	100 x 175 mm
27-131	100 x 200 mm



27-132 - 139

27-132	165 x 85 x 35 mm
27-133	200 x 100 x 35 mm
27-134	200 x 100 x 50 mm
27-135	230 x 130 x 50 mm
27-136	260 x 150 x 50 mm
27-137	270 x 235 x 50 mm
27-138	300 x 200 x 50 mm
27-139	325 x 275 x 50 mm



27-140
205 x 105 x 35 mm



27-141 - 142

- 27-141 | Martin Sterilizing Forceps
consisting of:
1 Sterilizing Forceps, curved, 25 cm,
without ratchet, with lid for jar
1 jar with bottom plate (anti-tilt)
- 27-142 | ditto, with 32 cm long Sterilizing Forceps

Round Metal Boxes and Medicine Cups

REALSTAR SURGICAL INSTRUMENTS



27-143 - 148

	Ø x H
27-143	75 x 60 mm
27-144	75 x 75 mm
27-145	100 x 60 mm
27-146	100 x 100 mm
27-146A	125 x 80 mm
27-147	125 x 125 mm
27-148	150 x 150 mm

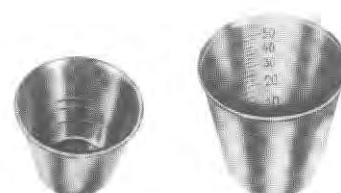

27-149
25 cc

27-150
50 cc



27-151
20 cc
Medicine Spoon



27-152
Ø75 x 12 mm
Tablet Tray



27-153
Ø90 x 90 mm
Metal Cup



27-154
Ø75 x 80 mm
Sputum Cup

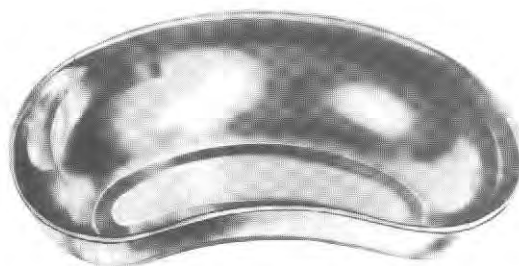

Kidney Dish

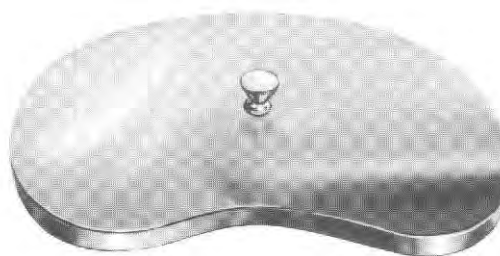

27-155 - 157

27-155	170 x 100 x 35 mm
27-156	250 x 140 x 40 mm
27-157	275 x 150 x 45 mm

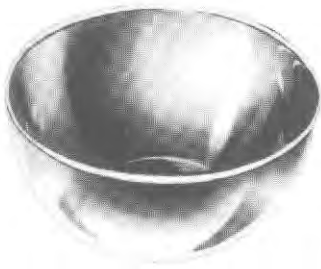

27-158 - 165

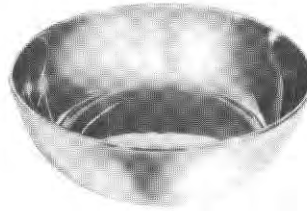

27-166 - 170

	Ø x H	
27-158	40 x 19 mm	0.05L
27-159	61 x 30 mm	0.07L
27-160	80 x 40 mm	0.14L
27-161	116 x 50 mm	0.35L
27-162	128 x 55 mm	0.45L
27-163	147 x 65 mm	0.70L
27-164	167 x 75 mm	1.10L
27-165	187 x 85 mm	1.60L

27-166	116 x 35 mm	0.30L
27-167	128 x 38 mm	0.40L
27-168	147 x 40 mm	0.50L
27-169	157 x 45 mm	0.75L
27-170	187 x 45 mm	1.00L



27-171
Ø 110 x 28 mm 0.15L

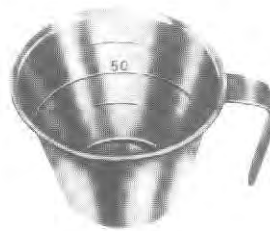

27-172
100 cc 0.1L



27-173 - 176
27-173 0,25L
27-174 0,50L
27-175 1,00L
27-176 2,00L



27-177
235 x 190 x 40 mm



27-178
Ø220 x 70 mm



27-179
Ø 50 x 100 mm
Powder Pot



27-180
Ø 50 x 75 mm
Methot With Lid



27-181
Ø 50 x 75 mm
Methot Without Lid

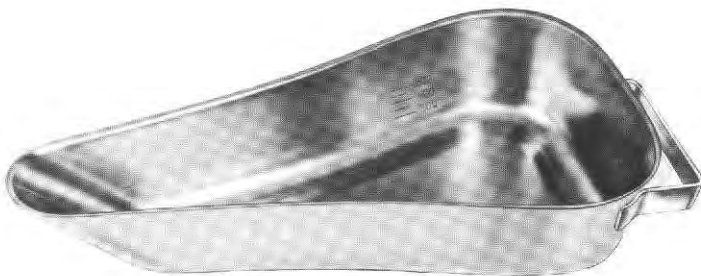

27-182

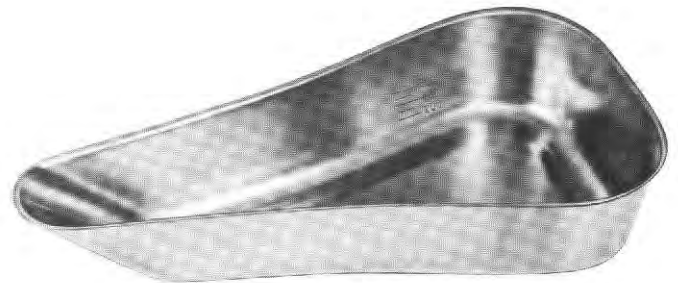

27-183

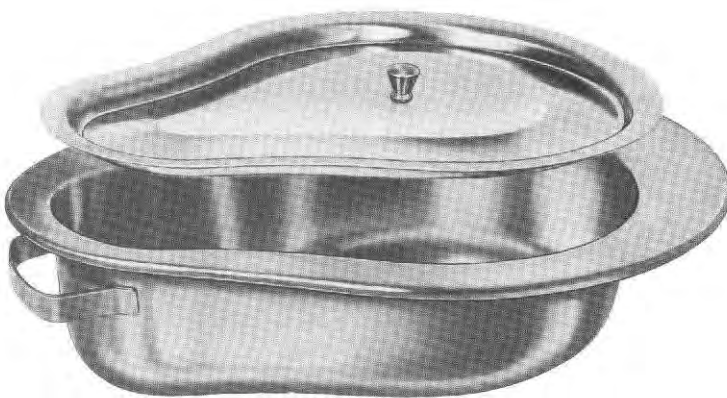

27-184

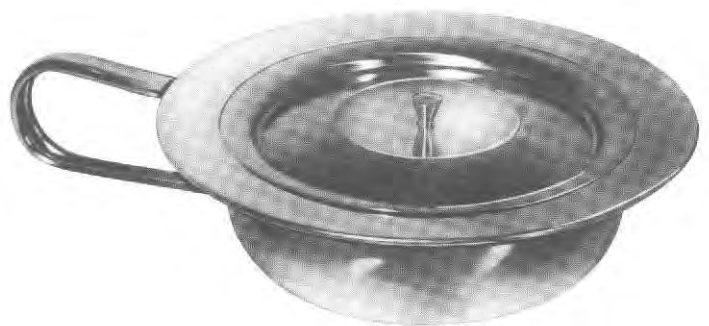

27-185 - 186

27-185 Ø235 mm
27-186 Ø310 mm

Needle Cases

REALSTAR SURGICAL INSTRUMENTS



27-187
Sauerbruch
210 x 125 x 17 mm



27-188
Sauerbruch
210 x 125 x 17 mm



27-189
150 x 95 x 13 mm



27-190
150 x 95 x 13 mm



27-191
150 x 95 x 13 mm



27-192
150 x 95 x 13 mm



27-193
150 x 95 x 13 mm



27-194
150 x 95 x 13 mm

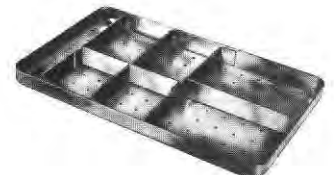

27-195
150 x 95 x 11 mm



27-196
Deponette
245 x 135 x 35mm



27-197
Deponette
245 x 135 x 50mm

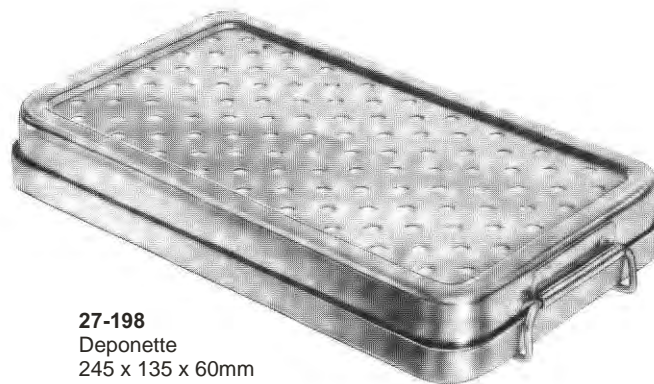

27-198
Deponette
245 x 135 x 60mm

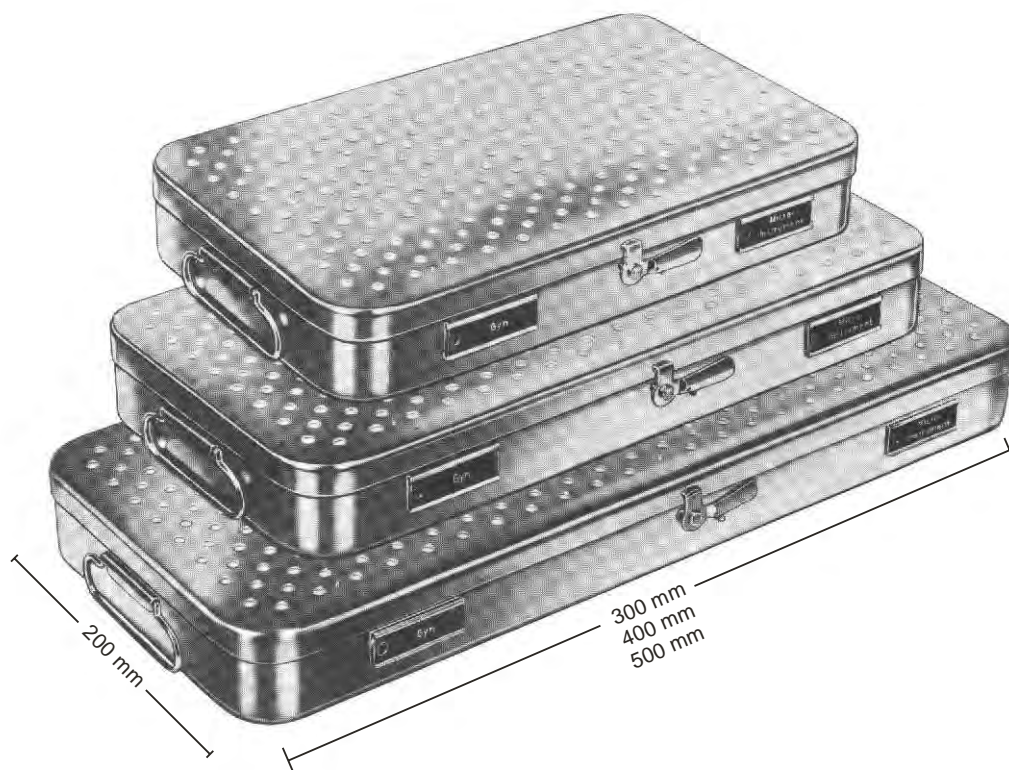

27-199 - 209

27-199	230 x 130 x 50	mm
27-200	260 x 150 x 50	mm
27-201	275 x 235 x 50	mm
27-202	300 x 200 x 50	mm
27-203	325 x 275 x 50	mm
27-204	420 x 175 x 50	mm
27-205	230 x 130 x 75	mm
27-206	260 x 150 x 75	mm
27-207	300 x 200 x 75	mm
27-208	325 x 275 x 75	mm
27-209	420 x 175 x 75	mm



27-210 - 212

27-210	480 x 250 x 50	mm
27-211	520 x 250 x 75	mm
27-212	520 x 250 x 100	mm



27-213 - 218

27-213	240 x 240 x 50	mm
27-214	240 x 240 x 80	mm
27-215	240 x 240 x 100	mm
27-216	480 x 260 x 50	mm
27-217	520 x 260 x 80	mm
27-218	520 x 260 x 100	mm

Sterilizing Basket

**REALSTAR SURGICAL
INSTRUMENTS**

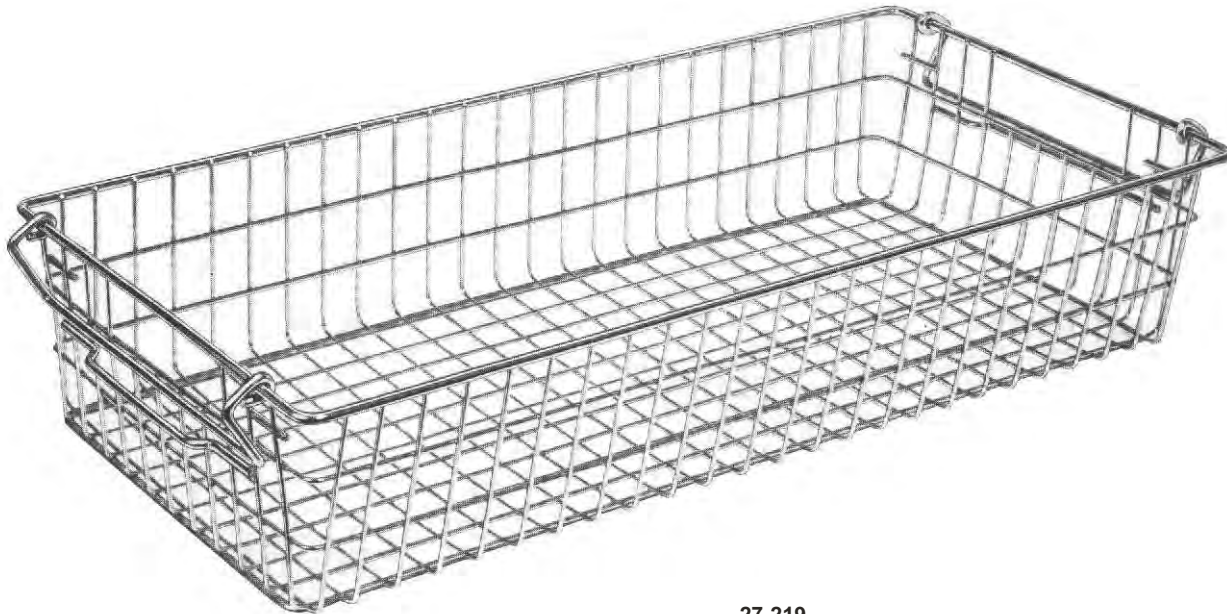

27-219
(60 x 30 x 15 cm)
Nominal dimensions

**REALSTAR SURGICAL
INSTRUMENTS**

SERVING TO SAVE LIVES

427

Gali Shah Khaki Wali Kashmir Street,
Rang Pura Road, Sialkot 51310-Pakistan
Phone: +92 3348033729
Fax: +92 52 4570067
E-mail: info@Realstarsurgical.com
Website: www.Realstarsurgical.com